



An Investigation into
THE RECOVERY OF COPPER AND NICKEL FROM COMPOSITE SAMPLES FROM THE
SELKIRK DEPOSIT
prepared for
NORTH AMERICAN NICKEL

Project 18559-01 – Final Report
December 22, 2021

NOTES

DISCLAIMER: This document is issued by the Company under its General Conditions of Service accessible at <http://www.sgs.com/en/Terms-and-Conditions.aspx>. Attention is drawn to the limitation of liability, indemnification and jurisdiction issues defined therein. Any holder of this document is advised that information contained hereon reflects the Company's findings at the time of its intervention only and within the limits of Client's instructions, if any. The Company's sole responsibility is to its Client and this document does not exonerate parties to a transaction from exercising all their rights and obligations under the transaction documents. Any unauthorized alteration, forgery or falsification of the content or appearance of this document is unlawful and offenders may be prosecuted to the fullest extent of the law.

WARNING: The sample(s) to which the findings recorded herein (the "Findings") relate was(were) drawn and / or provided by the Client or by a third party acting at the Client's direction. The Findings constitute no warranty of the sample's representativeness of any goods and strictly relate to the sample(s). The Company accepts no liability with regard to the origin or source from which the sample(s) is/are said to be extracted.

ACCREDITATION: SGS Minerals Lakefield is accredited to the requirements of ISO/IEC 17025 for specific tests as listed on our scope of accreditation, including geochemical, mineralogical, and trade mineral tests. To view a list of the accredited methods, please visit the following website and search SGS Lakefield: <http://palcan.scc.ca/SpecsSearch/GLSearchForm.do>.

Table of Contents

Executive Summary	v
Introduction.....	ix
Testwork Summary	1
1. Sample Receipt and Preparation	1
1.1. Individual Samples Preparation	2
1.2. Composites Preparation	3
2. Head Characterization.....	5
2.1. Head Assays.....	5
2.2. Mineralogy	7
2.2.1. Mineral Modals	7
2.2.2. Nickel Department.....	9
2.2.3. Liberation and Association	10
3. Grindability Testwork	14
3.1. SMC Test.....	14
3.2. Bond Rod Mill Grindability Test	15
3.3. Bond Ball Mill Grindability Tests	16
3.4. Bond Abrasion Tests	17
4. Flotation Testwork	18
4.1. Test Program Overview	18
4.2. Flowsheet Development	19
4.2.1. Primary Grind	19
4.2.2. Cleaner Flowsheet Development	20
4.3. Flowsheet Evaluation with HG Comp	24
4.4. Locked Cycle Testing	26
4.4.1. LCT-4 Test Results	26
4.4.2. LCT-5 Test Results	27
4.4.3. LCT-4 and LCT-5 Combined Results.....	27
4.5. Detailed Concentrate Assays	30
Conclusions and Recommendations	32
Appendix A – Sample Receipt and Preparation.....	34
Appendix B – Head Characterization	37
Appendix C – Grindability Testing.....	80
Appendix D – Batch Flotation Testing.....	132

List of Tables

Table I: Head Assay and Hardness of Testing Samples	v
Table II: LCT-4 and LCT-5 Metallurgical Projection	vii
Table 1: As-received Sample Inventory and Weights	2
Table 2: Composites Weights	4
Table 3: Head Assays of Test Composites	6
Table 4: Nickel in Sulphide Distribution	7
Table 5: Mineral Modals of Head Samples	8
Table 6: SMC Test Results	15
Table 7: Bond Rod Mill Grindability Test Results	15
Table 8: Bond Ball Mill Grindability Test Results	16
Table 9: Bond Abrasion Test Results	17
Table 10: Summary of Test Objectives	18
Table 11: Mineral Composition Summary	19
Table 12: Summary of Testing Conditions for tests F-24 to F-26	19
Table 13: Summary of Flotation Results of Tests F-24 to F-26 at Various Primary Grinds	20
Table 14: Summary of Test Conditions of F-30 to F-36	22
Table 15: Results Summary of Flotation Tests F-30 to F-36	23
Table 16: Summary of Testing Conditions of F-27, F-38, and F-40	24
Table 17: Results Summary of Tests F-27, F-38, and F-40 (HG Comp)	25
Table 18: Summary of Test Conditions for LCT-4 and LCT-5	26
Table 19: LCT-4 Metallurgical Projection (C-F)	29
Table 20: LCT-5 Metallurgical Projection (B-E) – Stage Performance	29
Table 21: Combined LCT-4 and LCT-5 Results	29
Table 22: Detailed Analysis on LCT-5 Products	31

List of Figures

Figure I: Locked Cycle Tests (LCT-4 and LCT-5) Flotation Flowsheet	viii
Figure 1: Generic Individual Sample Preparation Flowsheet.....	3
Figure 2: Generic Flotation Composite Sample Preparation Flowsheet.....	4
Figure 3: Generic Grindability Composite Sample Preparation Flowsheet	5
Figure 4: Sulphide Nickel Department of LG Comp (Size by Size) and HG Comp	9
Figure 5: Chalcopyrite Association in the Head Samples	11
Figure 6: Pentlandite Association in the Head Samples	12
Figure 7: Pyrrhotite Association in the Head Samples	13
Figure 8: Mineral Release Curves for the LG Comp.....	14
Figure 9: RWI of Grind Composites Compared to the SGS Database	15
Figure 10: BWI of Grind Composites Compared to the SGS Database	16
Figure 11: AI of Grind Composites Compared to the SGS Database	17
Figure 12: Flotation Results of Tests F-24 to F-26	20
Figure 13: Flowsheet of LCT-4	28
Figure 14: Flowsheet of LCT-5	28

Executive Summary

Two composite samples (LG Comp and HG Comp) from the Selkirk deposit were prepared for metallurgical testwork program. They represent low grade (LG) and high grade (HG) samples taken from the Selkirk deposit. The main objective of the study was to develop a flowsheet to produce separate marketable copper concentrate (>30% Cu, <1% Ni) and nickel concentrate (>10% Ni) with maximized recoveries. The current testwork demonstrated that the two concentrates with target grades could be achieved with reasonably good recoveries. It is notable that this was a quickly executed test program aimed at demonstrating what level of metallurgy may be possible instead of a rigorous redevelopment.

A summary of feed characteristics and the hardness characteristics of the two composite samples is provided in Table I. The copper feed grade varied from 0.55% Cu in the LG Comp to 0.66% Cu in the HG Comp. The nickel feed grade varied from 0.44% Ni in the LG Comp to 0.77% Ni in the HG Comp. Nickel sulphide (Ni(s)) assays suggested the majority of the nickel was in sulphide form. Hardness testing revealed the samples to be moderately hard to very hard, and medium abrasive.

Table I: Head Assay and Hardness of Testing Samples

Analysis	Unit	LG Comp	HG Comp
Cu	%	0.55	0.66
Ni	%	0.44	0.77
Ni(s)	%	0.41	0.75
Fe	%	12.7	20.1
S	%	5.76	10.5
SMC	A x b	23.9	30.1
	ta	0.20	0.23
	SCSE (kWh/t)	14.3	12.8
AI	g	0.33	0.25
RWI	kWh/t	18.6	15.8
BWI	kWh/t	19.6	16.0

A subsample from each of the LG Comp and the HG Comp was submitted for QEMSCAN mineralogy at a grind size of 80% passing 129 µm and 99 µm, respectively. The major sulphide minerals were identified as chalcopyrite, pentlandite, pyrrhotite, with trace amounts of pyrite. About 80-85% of the nickel was contained in pentlandite, and the remaining nickel 12-15% was mostly hosted by pyrrhotite in solid solution. Minor amounts of nickel (~3%) were hosted by non-sulphide gangue minerals.

The liberation of chalcopyrite was good for both composites, with 74-83% free and liberated, but pentlandite was poorly liberated, with 46-55% free and liberated, at the grind size submitted for mineralogy. The use of regrinding is critical to fully liberate pentlandite for maximizing the nickel recovery and grade.

The flotation flowsheet selected is summarized in Figure I. The flowsheet involved grinding to 80% passing ~90 µm followed by Cu/Ni bulk flotation to recover the majority of the copper and nickel. Cu/Ni rougher concentrate was reground to a P₈₀ of ~25 µm and cleaned once to reject pyrrhotite and non-sulphide gangue. The bulk Cu/Ni cleaner concentrate was further polish ground to clean the mineral surface before undergoing copper-nickel separation. A Po circuit was performed on the Cu/Ni tailings to scavenge residual nickel. A Po rougher was reground to a P₈₀ of ~15 µm and cleaned to produce a lower grade nickel concentrate.

Locked cycle test LCT-4 was completed to demonstrate the bulk Cu/Ni and Po circuits, while LCT-5 was performed to demonstrate the Cu-Ni separation circuit. The combined LCT-4 and LCT-5 results are presented in Table II.

The recovery of copper was reasonable, achieving 55% to the Cu concentrate and 86% recovery between the two concentrates. High grade copper concentrate was achieved at 33% Cu. The low nickel content (0.32% Ni) in the copper concentrate was also achievable. Nickel concentrate (combined Copper Rougher Scavenger Tails and Po 3rd Cleaner Concentrate) grade of 10% Ni containing approximately 6% Cu was achieved. The nickel recovery was reasonably good at 63%. Attractive amounts of platinum group elements were present in the concentrates with no obvious deleterious elements.

The flotation testwork also demonstrated that a Po Rougher Scavenger Tailings with a low sulfur content (<1%) was achievable.

Table II: LCT-4 and LCT-5 Metallurgical Projection

Product	Wt %	Assays, %, g/t						% Distribution					
		Cu	Ni	S	Pt, g/t	Pd, g/t	Au, g/t	Cu	Ni	S	Pt	Pd	Au
Cu 3rd CI Conc	0.9	33.2	0.32	34.4	1.79	36.0	5.03	54.6	0.7	5.7	7.3	40.1	38.8
Cu Ro Scav Tail	2.3	5.88	10.3	33.1	3.65	7.96	1.59	27.1	52.2	13.0	36.1	21.6	30.0
Po 3rd CI Conc	0.4	5.03	10.5	36.5	5.91	14.4	1.50	4.5	10.4	2.8	11.4	7.7	5.5
Po 1st CI Tails	13.3	0.20	0.75	22.6	0.23	0.57	0.06	5.4	22.3	52.5	13.7	9.1	7.0
Po Ro Scav Conc	4.0	0.12	0.53	25.1	0.25	0.54	0.06	1.0	4.8	17.8	4.5	2.6	2.1
Po Ro Scav Tailings	79.1	0.05	0.05	0.59	0.08	0.20	0.03	7.4	9.7	8.2	27.0	18.9	16.6
Comb. Ni Conc (Cu Ro Scav Tails + Po 3rd CI Conc)	2.7	5.74	10.3	33.7	4.02	9.0	1.58	31.6	62.5	15.8	47.5	29.3	35.6
Cu Conc & Ni Conc.	3.6	11.7	7.8	34.1	3.45	15.9	2.46	86.2	63.2	21.6	54.8	69.4	74.4
Head (Calc.)	100	0.49	0.44	5.72	0.23	0.83	0.12	100	100	100	100	100	100
Head (Dir.)		0.55	0.44	5.76	0.18	0.82	0.07						

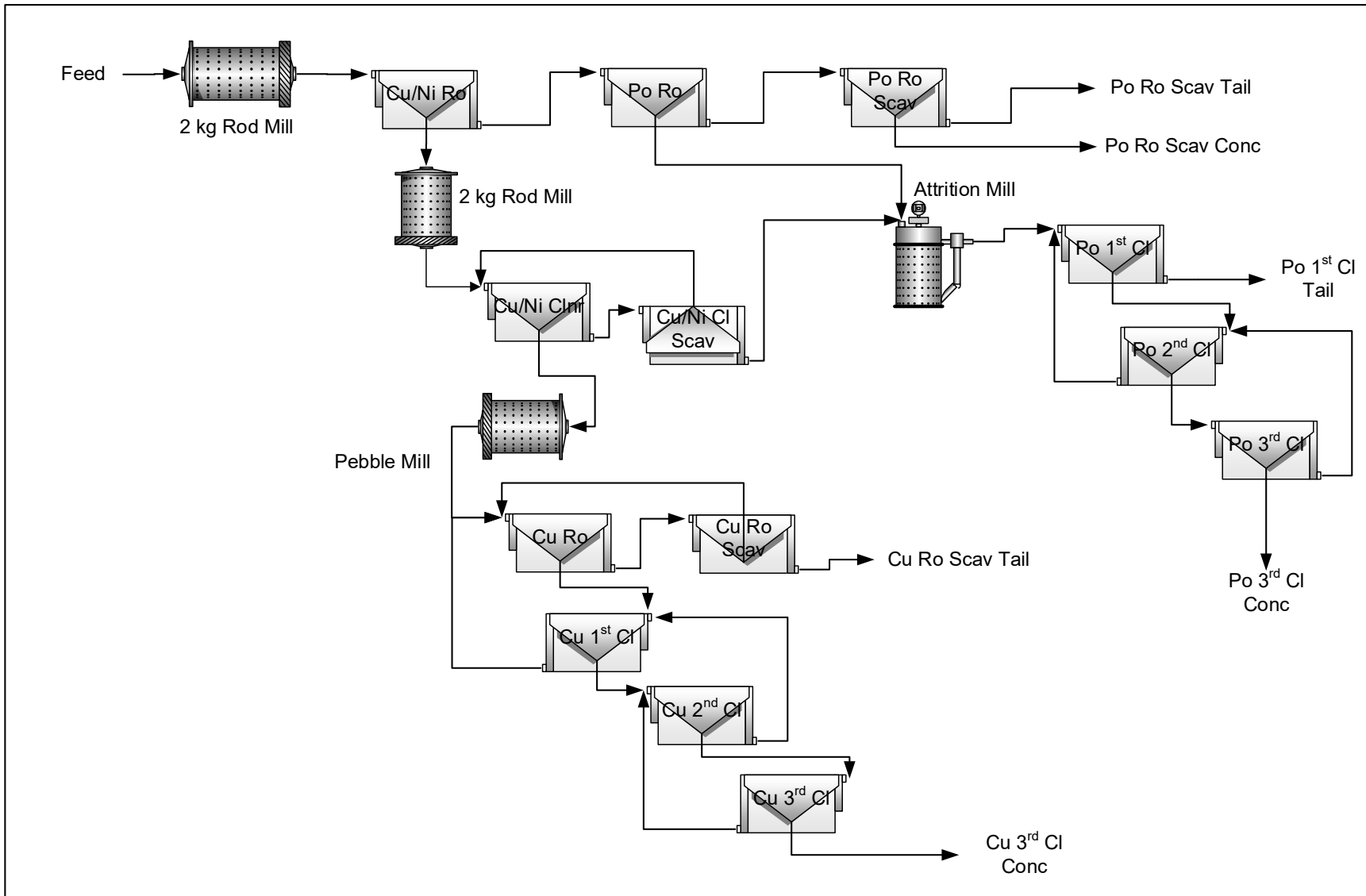

Figure I: Locked Cycle Tests (LCT-4 and LCT-5) Flotation Flowsheet

Introduction

Mr. Mike Ounpuu on behalf of North American Nickel contacted SGS Minerals with a request for re-development of the Phikwe-Selebi and Selkirk milling process flowsheet. Two separate reports were prepared. This report covers the testwork performed on the Selkirk Sample.

The main objective of the current study is to evaluate a more typical flotation approach to this style of mineralization, with the goal to generate separate marketable Cu and Ni concentrates. The metallurgical targets for this program are to maximize recoveries into concentrates having the following grades:

- A Cu concentrate expected to be approximately 30% Cu and <1% Ni.
- A Ni concentrate grading >10% Ni, but hopefully closer to 12% Ni.

The scope of work included feed characterization (assays and mineralogy), ore hardness evaluations, and flotation testing on two samples.

This report presents the results of the testwork. Results were provided to Mr. Mike Ounpuu, North American Nickel's consultant, as they became available. Progress was discussed with Mr. Ounpuu, regularly over the course of the program.

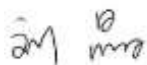

Jing Liu, PhD
Metallurgist



Dan Imeson, M.Sc.
Manager – Mineral Processing

*Experimental work by: D. Ariyanayagam, M. Lortie
Report preparation by: J. Liu
Reviewed by: D. Imeson*

Testwork Summary

1. Sample Receipt and Preparation

A shipment of individually marked core samples was received at the SGS Lakefield facility on July 22, 2021 from the Selkirk deposit and assigned the internal receipt number 0252-JUL21. The shipment consisted of two skids of 19 pails weighing 354.4 kg in total. Five pails of samples were immediately dispatched to the client for additional testwork.

Each pail allocated for metallurgical testing consisted of individual bagged samples with distinct identification numbers marked on the bags. All fifty-six (56) of the as-received samples were used for making up the composites (LG Comp and HG Comp) for this testing program. A summary of the as-received samples and the inventoried weights are summarized in Table 1. Thirty-six (36) samples were selected to make up the LG Comp, and twenty (20) samples were selected to make up the HG Comp.

Table 1: As-received Sample Inventory and Weights

LG Samples		HG Samples	
Sample ID	Mass (kg)	Sample ID	Mass (kg)
D15656	4.14	D15719	5.18
D15657	4.30	D15720	5.25
D15658	4.46	D15721	4.39
D15659	4.44	D15730	4.90
D15660	5.22	D15731	4.86
D15663	5.49	D15733	5.12
D15664	3.95	D15734	4.83
D15665	4.59	D15735	5.10
D15666	4.75	D15736	4.40
D15667	4.61	D15737	5.43
D15668	4.29	D15738	4.85
D15669	4.48	D15739	4.74
D15670	4.48	D15740	5.04
D15678	4.93	D15741	5.52
D15687	4.40	D15742	5.17
D15688	5.27	D15751	4.06
D15689	4.48	D15752	6.26
D15690	5.15	D15764	5.07
D15694	5.24	D15765	4.54
D15695	4.23	D15768	5.27
D15700	5.15		
D15702	5.79		
D15703	4.70		
D15707	4.96		
D15708	4.09		
D15711	5.05		
D15713	4.86		
D15714	4.37		
D15715	4.56		
D15716	5.16		
D15717	4.58		
D15718	5.00		
D15722	4.51		
D15723	4.53		
D15724	3.19		
D15725	5.95		

1.1. Individual Samples Preparation

All fifty-six (56) of the samples were separately prepared for the test program. Each sample was crushed to nominal 1.5" (or 40 mm). One-quarter of each LG samples and one-half of each HG samples was split for grindability composite makeup. The remaining three-quarters or one-half were crushed to nominal 6

mesh (or 3.4 mm). Approximately 100 g was split from this and pulverized for Cu, Ni, Pt, Pd, Au, and S assays. Another 100 g was split, pulverized, and shipped to client. The remaining sample was stored for flotation composite makeup. The generic sample preparation flowsheet applied to each of the tested samples as illustrated in Figure 1.

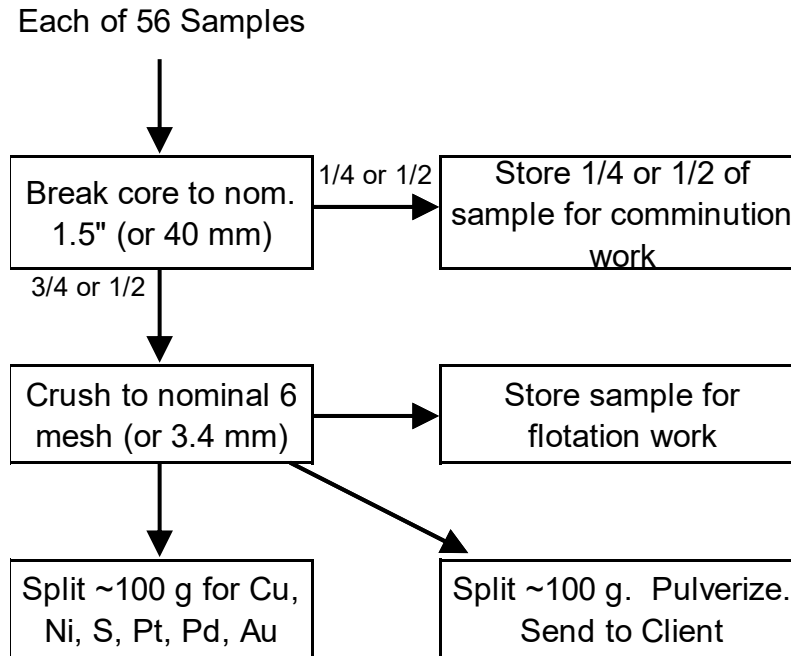

Figure 1: Generic Individual Sample Preparation Flowsheet

1.2. Composites Preparation

Two composites were prepared for the test program – Low-Grade Composite (LG Comp) and High-Grade Composite (HG Comp), following the instructions provided by the client.

Figure 2 and Figure 3 depict the generic sample preparation flowsheet for the flotation composites and grindability composites, respectively. For the flotation composite preparation, the selected individual samples (nominal 6 mesh) were composited at the instruction of the client. Once blended, a subsample of about 50-60 kg was taken and stage-crushed to -10 mesh (or 1.7 mm). This was blended and rotary split into 2 kg test charges. Approximately 100-200 g was split and pulverized for Cu, Ni, Ni(S), S, Pt, Pd, Au, and ICP Scan assays. The remaining sample was stored for potential future testwork.

For the grindability composite preparation, the selected samples (nominal 1.5") were composited in the same ratio as the flotation composites. About 25 kg was taken for the SMC test, about 5 kg was used for AI test. The remainder of the grindability composite was combined with the SMC reject and was stage-crushed to -1/2" (or 12.7 mm). A 15 kg subsample was submitted for the Bond rod mill grindability test

(RWI). About 10 kg was stage-crushed to -6 mesh (or 3.35 mm) and submitted for the Bond ball mill grindability test (BWI).

The weights of the flotation composites and grindability composites are summarized in Table 2. Full details of the sample preparations are provided in the appendix (Appendix A).

Table 2: Composites Weights

Comp ID	Weights, kg	
	Float Comp	Grind Comp
LG Comp	125	44
HG Comp	50	50

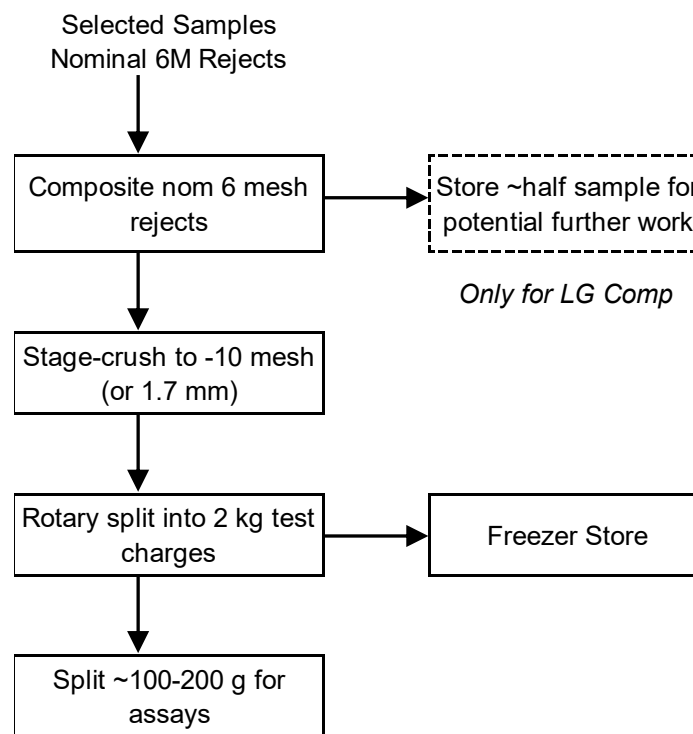

Figure 2: Generic Flotation Composite Sample Preparation Flowsheet

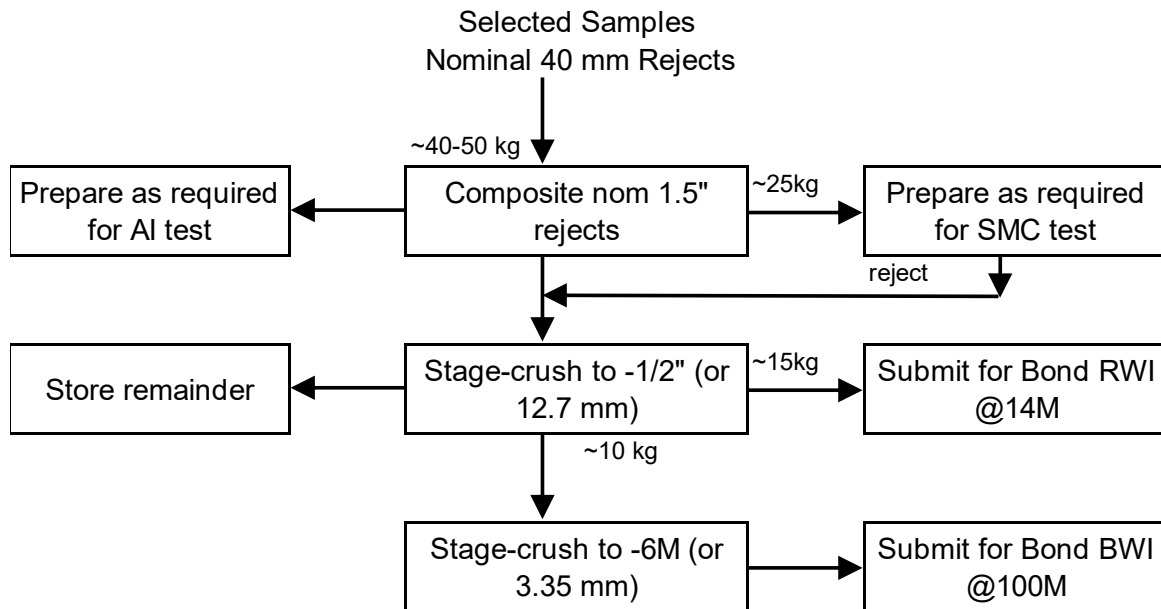

Figure 3: Generic Grindability Composite Sample Preparation Flowsheet

2. Head Characterization

2.1. Head Assays

A subsample of each of the fifty-six (56) individual samples was submitted for assays, which included copper, nickel, gold, platinum, palladium, and sulphur. The results are provided in Appendix B.

A subsample of each of the two flotation composites was submitted for head assays, which included copper, nickel, nickel as sulphide (NiS), sulphur, gold, platinum, palladium, rhodium, mercury, and ICP-MS Scan analysis. Another subsample was submitted to analyze the nickel in the methanol bromine leach residue. The head assays are summarized in Table 3.

The distribution of the nickel in sulphide was calculated with the following two methods. Results are shown in Table 4.

- Method A: Based on the Ni(s) and the total nickel direct assays, the difference of these two was calculated to be the nickel in non-sulphide minerals.
- Method B: Based on the Ni(s) and Ni% in leach residue, calculate the total nickel.

The Method B calculation shows a slightly higher Ni(s) distribution, at 97% for both samples, than that calculated by Method A, at 92% for LG Comp and 95% for HG Comp.

Table 3: Head Assays of Test Composites

Analyte	Unit	LG Comp	HG Comp
Cu	%	0.55	0.66
Ni	%	0.44	0.77
Ni(s)	%	0.41	0.75
Fe	%	12.7	20.1
S	%	5.76	10.5
Si	%	16.3	13.4
Au	g/t	0.07	0.08
Pt	g/t	0.18	0.37
Pd	g/t	0.82	1.28
Rh	g/t	< 0.02	< 0.02
Hg	g/t	< 0.3	< 0.3
Ag	g/t	3.4	3.7
Al	g/t	88600	73300
As	g/t	< 10	< 10
Ba	g/t	37	23
Be	g/t	< 0.09	< 0.09
Bi	g/t	2.3	3.4
Ca	g/t	72900	61100
Cd	g/t	2.4	2.7
Co	g/t	276	456
Cr	g/t	1160	625
K	g/t	1230	661
Li	g/t	< 20	< 20
Mg	g/t	52900	45900
Mn	g/t	895	874
Mo	g/t	1.8	1.7
Na	g/t	7520	5920
P	g/t	81	120
Pb	g/t	28.9	34.3
Sb	g/t	< 0.8	< 0.8
Se	g/t	14	22
Sn	g/t	< 2	< 2
Sr	g/t	82.2	74.8
Ti	g/t	1070	841
Tl	g/t	< 0.4	< 0.4
U	g/t	< 0.4	< 0.4
V	g/t	80	71
Y	g/t	4.2	4.6
Zn	g/t	127	114

Table 4: Nickel in Sulphide Distribution

	Element	Assay, %		Ni (S) Distribution	
		LG Comp	HG Comp	LG Comp	HG Comp
Method A	Ni(s)	0.41	0.75	93.6	96.8
	Ni(s) - Repeat	0.40	0.71	90.9	92.2
	Ni(s) - Average	0.41	0.73	92.3	94.5
Method B	Ni(s) - Repeat	0.40	0.71	96.6	97.0
	Ni in Leach Residue	0.02	0.03	3.4	3.0
	Ni Total calc.	0.41	0.73	100	100
	Ni Total dir.	0.44	0.77		

2.2. Mineralogy

The subsample used for the mineralogy study was taken from the product of the grind calibration test at 30 minutes in a 2 kg rod mill. The K₈₀ of LG Comp and HG Comp for 30 minutes of grinding were 129 µm and 99 µm, respectively. The LG Comp sample was screened into four size fractions, i.e., +106 µm, -106/+53 µm, -53/+20 µm, and -20 µm. The HG Comp was submitted as received, unsized. Each sample was assayed and mounted into graphite-impregnated polished sections.

The following sections briefly discuss mineral modals, nickel department, and liberation and association of the main sulphide minerals. Further information can be found in Appendix B.

2.2.1. Mineral Modals

The mineral modals are summarized in Table 5. The major sulphide minerals included chalcopyrite (the only copper mineral), pentlandite (the primary nickel carrier), and pyrrhotite, with trace to minor amounts of pyrite/marcasite. The non-sulphide minerals mainly included chlorite/clays, amphibole/pyroxene, plagioclase, epidote, and quartz. It's worthwhile mentioning that almost half of the chlorite/clays were distributed in the minus 20 µm fraction for the LG Comp. Flotation entrainment of chlorites/clays at this size range could be problematic.

Table 5: Mineral Modals of Head Samples

Sample		LG Comp 30 min K ₈₀ = 129 µm									HG Comp 30 min K ₈₀ = 99 µm
Fraction		Combined	+106µm		-106/+53µm		-53/+20µm		-20µm		As Received
Mass Size Distribution (%)		100.0	28.9		23.3		17.8		30.0		100.0
Mineral	Mass (%)	Sample	Sample	Fraction	Sample	Fraction	Sample	Fraction	Sample	Fraction	Sample
	Pyrrhotite	11.2	1.9	6.4	3.0	12.7	3.3	18.4	3.1	10.4	22.7
	Chalcopyrite	1.4	0.2	0.5	0.3	1.3	0.4	2.2	0.6	2.0	1.4
	Pentlandite	1.2	0.1	0.5	0.2	0.9	0.3	1.8	0.5	1.7	1.9
	Pyrite/Marcasite	0.1	0.0	0.1	0.0	0.1	0.0	0.1	0.0	0.1	0.4
	Other Sulphides	0.0	0.0	0.0	0.0	0.0	0.0	0.0	0.0	0.0	0.1
	Fe-Oxides	0.3	0.0	0.1	0.0	0.1	0.1	0.3	0.2	0.6	0.1
	Other Oxides	0.0	0.0	0.1	0.0	0.0	0.0	0.0	0.0	0.0	0.0
	Chlorite/Clays	26.2	5.6	19.3	4.3	18.5	3.6	20.4	12.6	42.1	20.5
	Biotite	0.1	0.0	0.1	0.0	0.1	0.0	0.1	0.0	0.0	0.1
	Talc	0.3	0.0	0.2	0.0	0.2	0.0	0.2	0.2	0.5	0.1
	Quartz	4.1	1.0	3.5	0.9	4.0	0.6	3.6	1.5	4.9	2.4
	Plagioclase	17.7	7.1	24.7	4.7	20.3	2.7	15.3	3.1	10.2	10.7
	Amphibole/Pyroxene	18.5	6.3	21.9	4.5	19.3	3.4	18.8	4.3	14.2	15.0
	K-Feldspar	0.1	0.0	0.1	0.0	0.1	0.0	0.1	0.0	0.1	0.0
	Epidote	17.3	6.0	20.9	4.8	20.5	3.0	16.9	3.4	11.5	22.7
	Titanite/sphene	0.4	0.1	0.5	0.1	0.5	0.1	0.3	0.1	0.4	0.3
	Other Silicates	0.4	0.2	0.7	0.1	0.6	0.1	0.4	0.0	0.1	0.7
	Carbonates	0.5	0.1	0.2	0.1	0.6	0.2	0.8	0.2	0.6	0.8
	Apatite	0.0	0.0	0.0	0.0	0.0	0.0	0.0	0.0	0.1	0.0
	Other	0.1	0.0	0.2	0.0	0.1	0.0	0.1	0.0	0.2	0.1
	Total	100.0	28.9	100.0	23.3	100.0	17.8	100.0	30.0	100.0	100.0

2.2.2. Nickel Department

Pentlandite hosted the majority of the nickel. Pyrrhotite and silicate gangue minerals were believed to contain low to very low levels of nickel in solid-solution based on historical data, at 0.5% and 0.03% Ni, respectively. Due to the abundance of pyrrhotite, the proportion of nickel in these minerals could be significant: 12% for LG Comp and 15% for HG Comp. The nickel distribution in sulphides other than pentlandite and pyrrhotite (i.e., millerite) was fairly low, ~1%. The department of sulphide nickel is summarized in Figure 4.

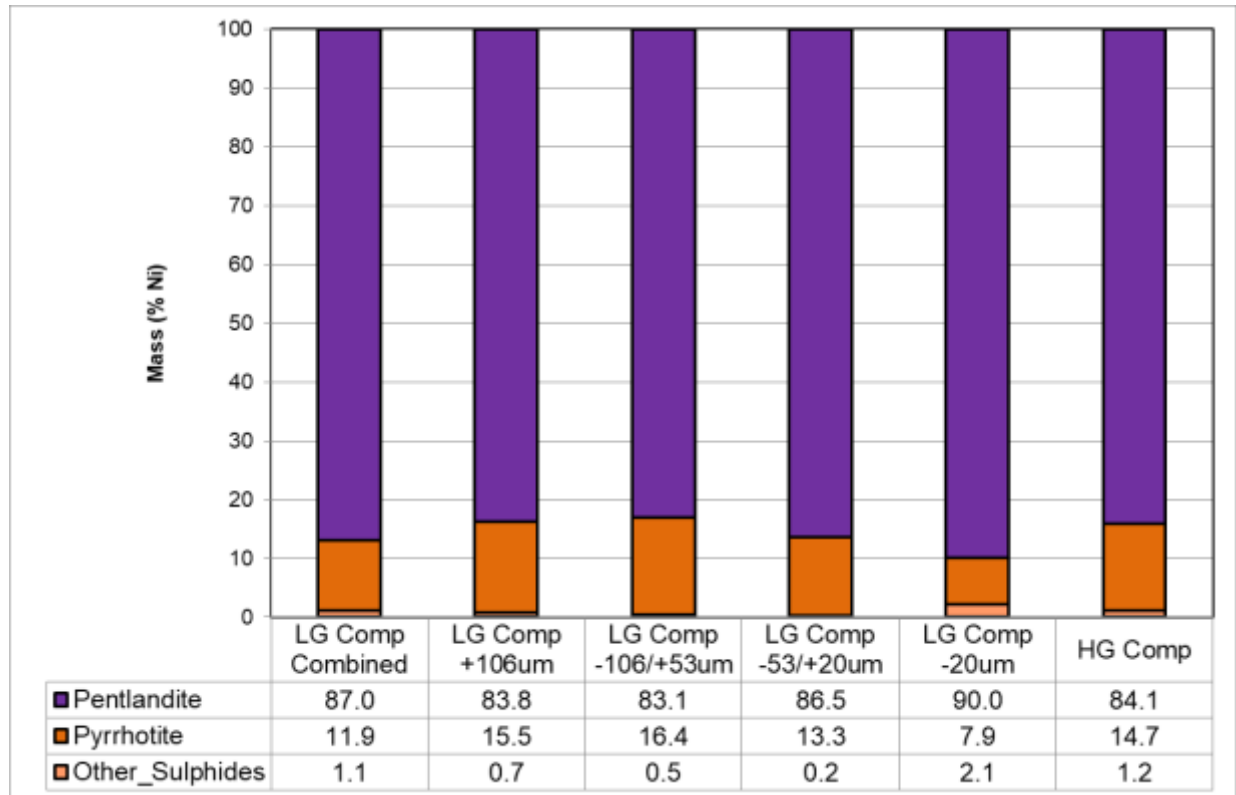

Figure 4: Sulphide Nickel Department of LG Comp (Size by Size) and HG Comp

2.2.3. Liberation and Association

The liberation classes of the minerals present in the ore have been defined as follows:

- Free: A mineral with >95% area percent of particle
- Liberated: A mineral with <95 but ≥80% area percent of particle
- Middlings: A mineral with <80% but ≥50% area percent of particle
- Sub-Middling: A mineral with <50% but ≥20% area percent of particle
- Locked: A mineral with <20% area percent of particle



The liberation of chalcopyrite was good for the LG Comp, 83% free and liberated, at a K_{80} of 129 μm ; not as good for the HG Comp, ~74% at a K_{80} of 99 μm .

The liberation of pentlandite was poor for both samples, ~46-55%. The portion of free and liberated pentlandite for the LG Comp improved to 81% at -20 μm . This indicates a fine regrind is likely required.

The pyrrhotite was found to be well-liberated for both samples, 83% free and liberated for the LG Comp (combined), and ~87% for the HG Comp.

The summary charts for the association of the chalcopyrite, pentlandite, and pyrrhotite are presented in Figure 5, Figure 6, and Figure 7, respectively. Additional information on liberation can be found in Appendix B. The non-liberated chalcopyrite was mainly associated with silicates. The non-liberated pentlandite was mainly associated with pyrrhotite, ~28-35% of the non-liberated pentlandite grains being associated with pyrrhotite. Regrinding will be required to better liberate pentlandite from pyrrhotite.

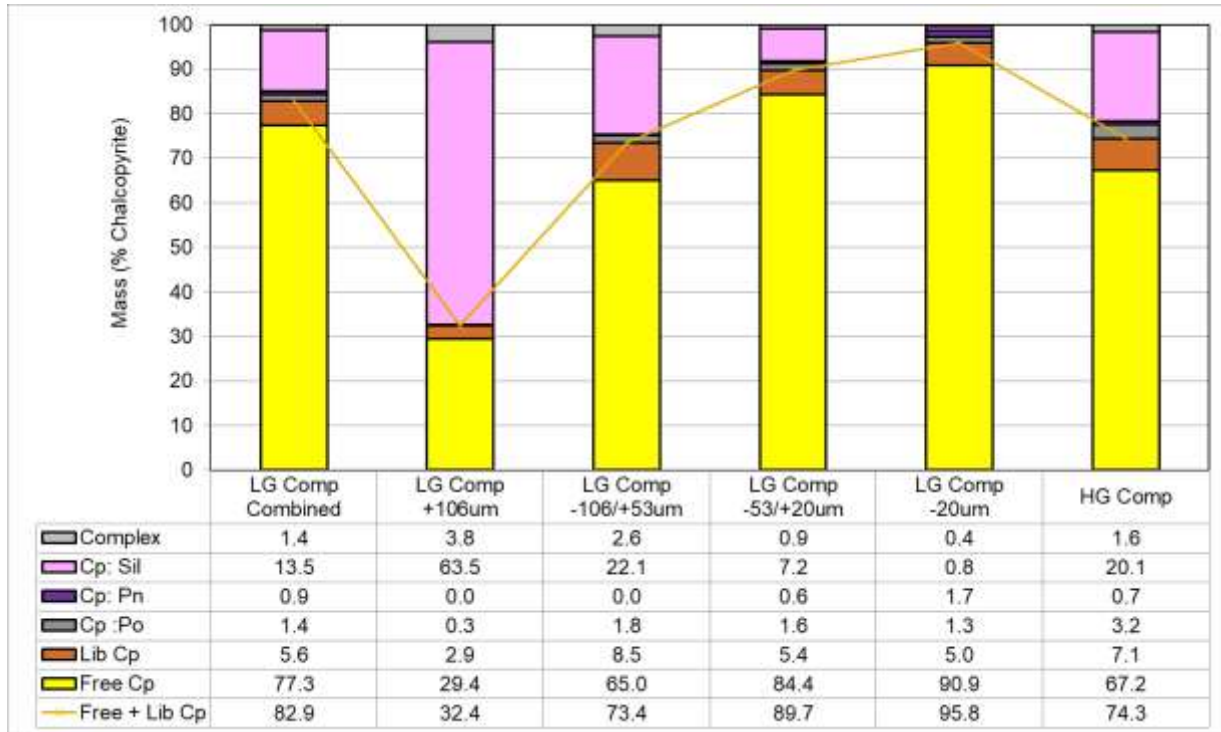

Figure 5: Chalcopyrite Association in the Head Samples

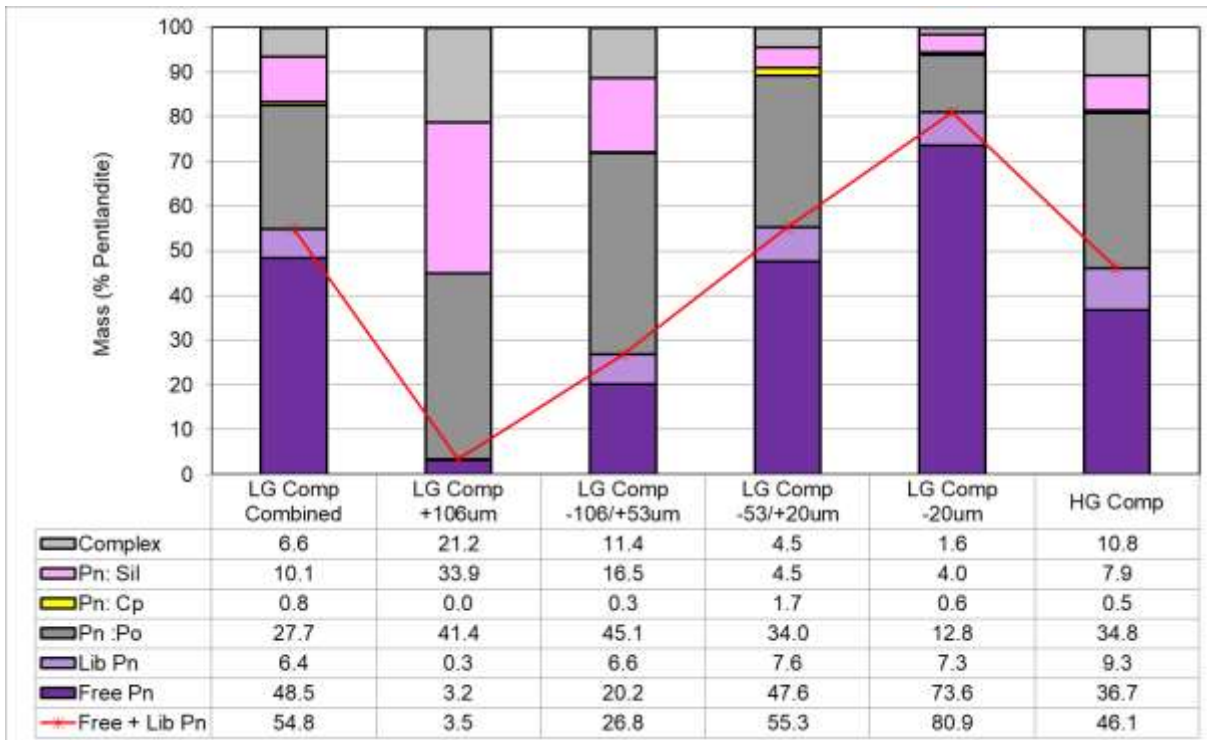

Figure 6: Pentlandite Association in the Head Samples

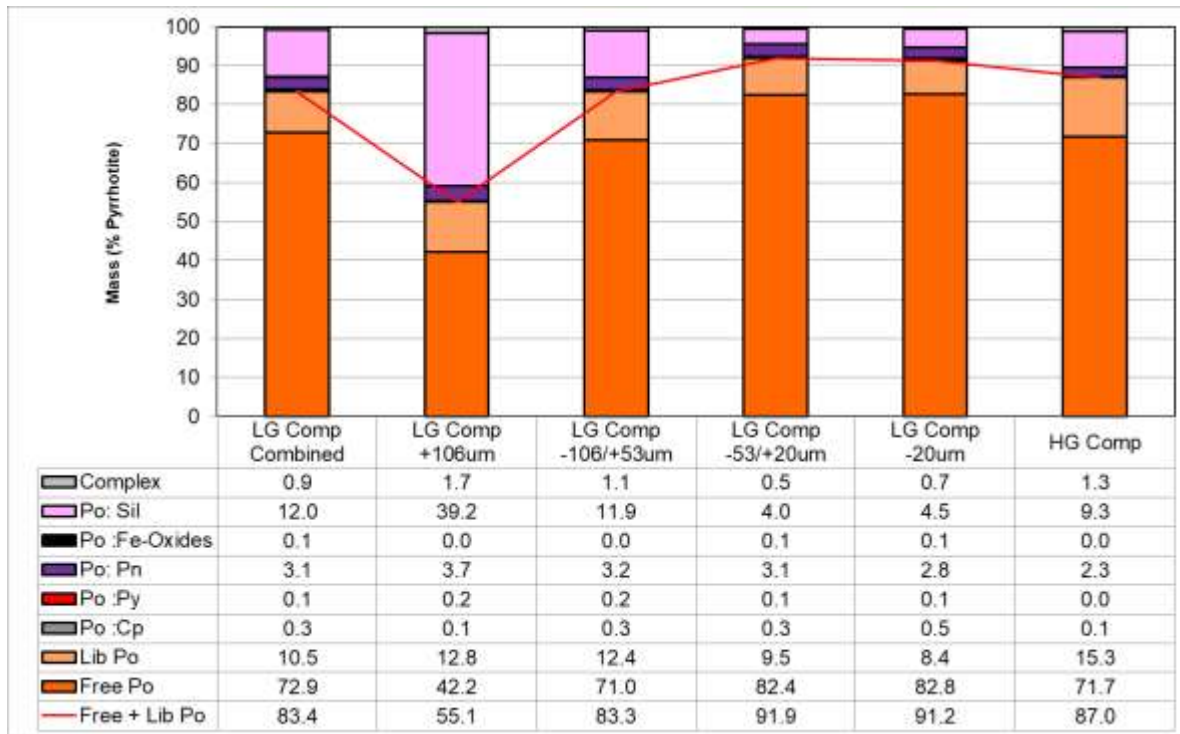

Figure 7: Pyrrhotite Association in the Head Samples

The effect of grind size on liberation of the major sulphide minerals is demonstrated by the mineral release curves in Figure 8, which shows that a primary grind at approximately 100 µm might be reasonable, but a fine regrind to ~15 µm or finer is likely necessary for good nickel recovery/grade.

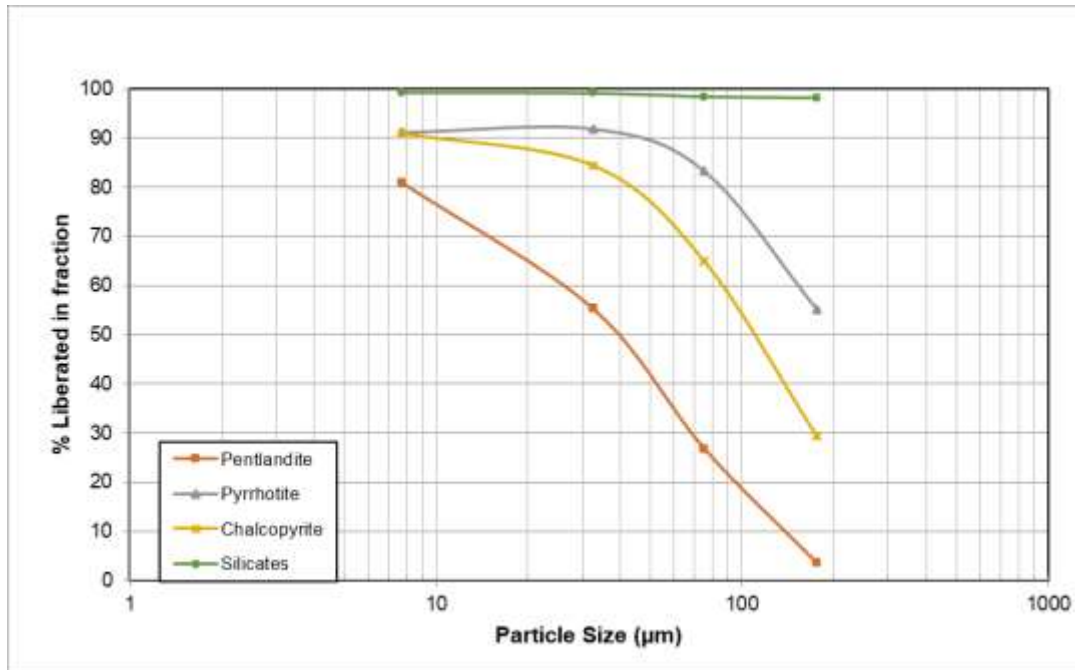

Figure 8: Mineral Release Curves for the LG Comp

3. Grindability Testwork

Each of the two grind composites (LG Comp and HG Comp) were submitted for the SMC test, Bond rod mill grindability test, Bond abrasion test, and Bond ball mill grindability test. Results are briefly summarized below. The complete test details are provided in Appendix C.

3.1. SMC Test

The SMC test is an abbreviated version of the standard JK drop-weight test performed on 100 rocks from a single size fraction (-31.5+26.5 mm in this case). The SMC test was performed on the two grind composite samples. The test results are summarized in Table 6 and detailed in the JKTech report which is appended (Appendix C), along with the test procedure, calibration, and test details.

The SMC test results are preferably calibrated against reference samples submitted to the standard JK drop-weight test (DWT) in order to consider the natural 'gradient of hardness' by size, which can widely vary from one ore to another. The SMC results were calibrated against the JK database average, as no standard DWT tests were performed as part of this project.

The samples were categorized as hard to very hard (LG Comp and HG Comp) in terms of resistance to impact breakage, with A x b values ranging from 23.9 to 30.1.

The relative densities varied from 3.15 to 3.41.

Table 6: SMC Test Results

Sample Name	A	b	A x b	Hardness Percentile	t _a ¹	DWI (kWh/m ³)	M _{ia} (kWh/t)	M _{ih} (kWh/t)	M _{ic} (kWh/t)	SCSE (kWh/t)	Relative Density
LG Comp	99.5	0.24	23.9	99	0.20	13.2	28.7	24.3	12.6	14.3	3.15
HG Comp	73.3	0.41	30.1	85	0.23	11.3	23.4	19.2	9.9	12.8	3.41

¹The t_a value reported as part of the SMC procedure is an estimate

3.2. Bond Rod Mill Grindability Test

Bond rod mill grindability tests were performed at 14 mesh of grind on the received samples. The test results are summarized in Table 7, and compared to the SGS database in Figure 9. The rod mill work indices (RWI's) for grind composites ranged from 15.8 to 18.6 kWh/t. The samples were categorized as moderately hard to hard.

Table 7: Bond Rod Mill Grindability Test Results

Sample Name	Mesh of Grind	F ₈₀ (µm)	P ₈₀ (µm)	Gram per Revolution	Work Index (kWh/t)	Hardness Percentile
LG Comp	14	10,538	898	5.98	18.6	88
HG Comp	14	10,486	902	7.79	15.8	65

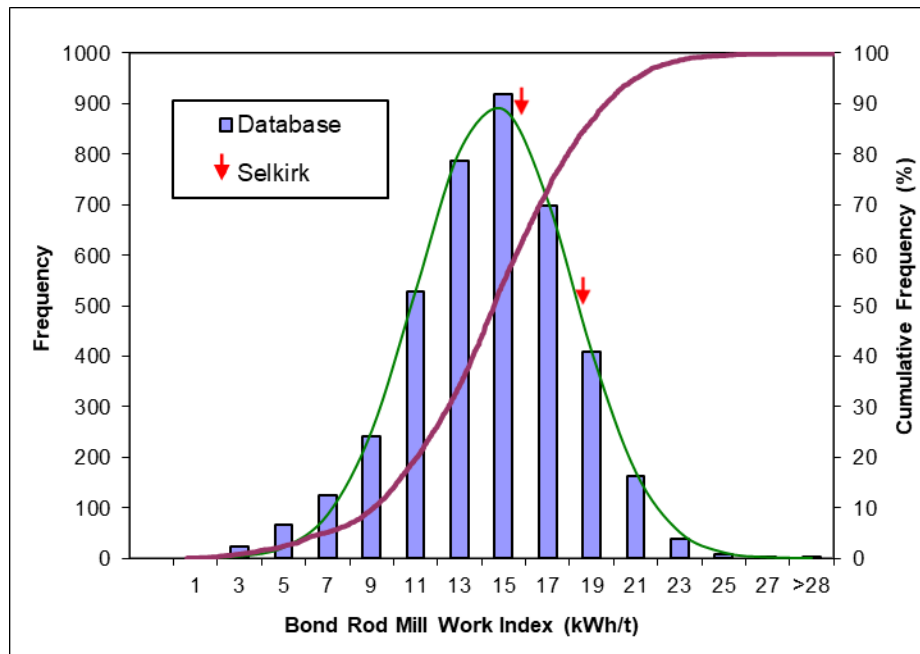

Figure 9: RWI of Grind Composites Compared to the SGS Database

3.3. Bond Ball Mill Grindability Tests

Bond ball mill grindability tests were performed at 100 mesh of grind on the received samples. The test results are summarized in Table 8, and compared to the SGS database in Figure 10. The test details are provided in Appendix C. The ball mill work indices (BWI's) for grind composites ranged from 16.0 to 19.6 kWh/t. The samples were categorized as moderately hard to very hard.

Table 8: Bond Ball Mill Grindability Test Results

Sample Name	Mesh of Grind	F ₈₀ (µm)	P ₈₀ (µm)	Gram per Revolution	Work Index (kWh/t)	Hardness Percentile
LG Comp	100	2,599	106	1.02	19.6	92
HG Comp	100	2,607	118	1.42	16.0	70

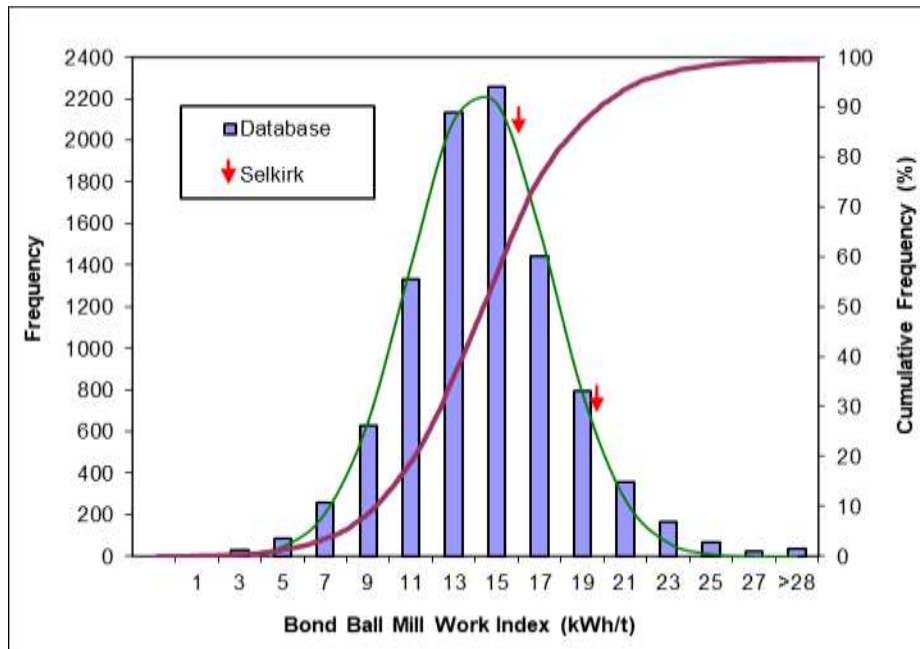

Figure 10: BWI of Grind Composites Compared to the SGS Database

3.4. Bond Abrasion Tests

Bond abrasion tests were performed on a 12.7 to 19 mm (1/2" to 3/4") fraction of the as-received crushed samples. The test results are summarized in Table 9 and compared to the SGS database in Figure 11. The samples were characterized as medium, the abrasion index (AI) ranging from 0.249 to 0.334 g.

Table 9: Bond Abrasion Test Results

Sample Name	AI (g)	Percentile of Abrasivity
LG Comp	0.334	57
HG Comp	0.249	44

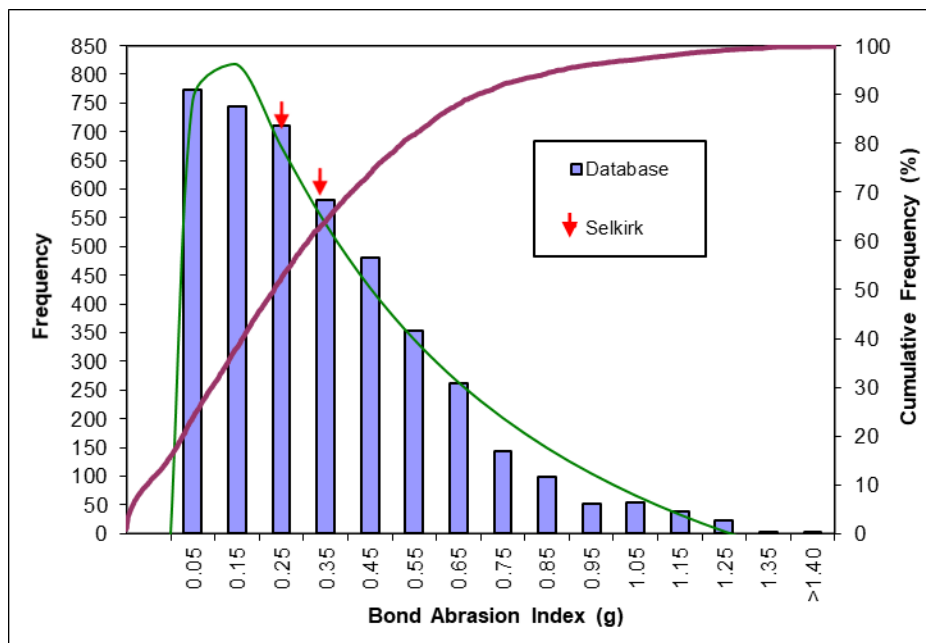

Figure 11: AI of Grind Composites Compared to the SGS Database

4. Flotation Testwork

4.1. Test Program Overview

The main objective of the flotation test program was to evaluate the flowsheet developed for the Selebi samples (SGS 18559-01 Report #1 – Phikwe - Selebi Samples) and make necessary modifications to produce separate marketable copper and nickel concentrates. The LG Comp was the main sample used for flowsheet development, followed by confirmatory tests using the HG Comp. Locked cycle tests were conducted on LG Comp sample.

A summary of test objectives is given in Table 10.

Table 10: Summary of Test Objectives

Test ID	Test Objective
LG Comp	
F24	Conduct rougher kinetics test, at K_{80} of 90 μm
F25	Conduct rougher kinetics test, at K_{80} of 120 μm
F26	Conduct rougher kinetics test, at K_{80} of 165 μm
F30	Based on F25, test the flowsheet with regrind Cu/Ni Ro Conc and regrind Cu/Ni Cl Scav 1 tails
F31	Similar to F30, without DETA in the regrind, and adding a third regrind of Cu/Ni Cl Scav 2 tails
F32	Similar to F31, with CMC in the Cu/Ni 1st Cleaner
F33	Similar to F32, Keep Po Ro Conc and Cu/Ni Ro separate
F34	Similar to F33, with additional Po Ro Scav, finer Po regrind, and 10g/t DETA and Na ₂ S in the Po cleaner
F35	Similar to F34, without DETA and Na ₂ S addition in the Po circuit
F36	Similar to F35, evaluate Cu/Ni Separation flowsheet
HG Comp	
F27	Conduct rougher kinetics test, at K_{80} of 87 μm
F38	Similar to F36, with HG Comp
F40	Similar to LCT-4, using HG Comp

All flotation tests were performed using laboratory Denver flotation cells applying industry standard flotation practices. The collector used in the program was Potassium Amyl Xanthate (PAX) and Aero MaxGold 900 (MX900). Lime was used as the pH modifier and MIBC was used as the frother. Diethylenetriamine (DETA) was used as an iron sulphide depressant and Carboxymethyl cellulose (CMC) was used as a magnesium silicate depressant. Copper sulphate and sodium sulphide were used as activators in selected tests.

Test products were filtered, dried, weighed, and submitted for Cu, Ni, Pt, Pd, Au, and S assays. Particle sieve analyses were completed to size coarser products (Flotation Feed or Rougher / Scavenger tailings), while a Malvern Mastersizer was used to size finer products (regrind product).

Flotation test details are provided in the appendix (Appendix D). A summary of test results is provided in the following sections.

The typical flowsheet was to recover most of the chalcopyrite (Cp) and pentlandite (Pn), i.e., the main copper and nickel minerals, during the Cu/Ni Rougher stage, while minimizing the recovery of pyrrhotite

(Po). The remaining pentlandite would be recovered during the Po Rougher stage, with higher pyrrhotite recoveries producing a low-grade concentrate. The Cu/Ni Rougher Concentrate and Po Rougher Concentrate were re-ground and cleaned separately. The Cu - Ni separation would be performed on the Cu/Ni Cleaner Concentrate, to produce a copper concentrate and a nickel concentrate (Cu Tailings).

The flotation test results included a calculation of mineral contents from the elemental assays. The mineral composition used for these calculations are summarized in Table 11.

Table 11: Mineral Composition Summary

	Cu	Ni	S	Other
Cp	34.1	0.0	33.9	32.0
Pn	0.0	36.4	31.5	32.1
Po	0.0	0.50	37.2	62.3
Ga*	0.00	0.03	0.00	99.97

Ga* represents the silicate gangue minerals

4.2. Flowsheet Development

4.2.1. Primary Grind

Three rougher flotation kinetics tests (F-24 to F-26) were performed, at various primary grind sizes (F_{80} of 90 μm , 120 μm , 165 μm), which included Cu/Ni Rougher flotation and Po Rougher flotation circuits. The testing conditions are summarized in Table 12.

Table 12: Summary of Testing Conditions for tests F-24 to F-26

Test ID	Cu/Ni Roughers					Po Roughers		
	F_{80} (μm)	MX900 g/t	PAX g/t	pH	Float Time min	PAX g/t	pH	Float Time min
F-24	90	5	10	8.4-9.0	5.0	30	natural	13
F-25	120	17.5	6	8.8-9.0	5.5	30	natural	13
F-26	165	12.5	6	8.9-9.0	5.0	30	natural	13

The flotation results of the rougher kinetics tests are summarized in Table 13 and depicted in Figure 12.

The copper, nickel, and palladium recoveries of Cu/Ni Rougher Concentrates 1-3 in tests F-24 and F-25, at a F_{80} of 90 μm and 120 μm , were similar, at 87-88% for copper, 75-76% for nickel, and 72% for palladium, with a mass pull of 12-13%. At a F_{80} of 160 μm , the recoveries of key valuable metals were lower, at 84% for copper, 67% for nickel, and 68% for palladium. Therefore, test F-25 at F_{80} of 120 μm with the better recoveries and coarser grind size was selected as the baseline for most of the subsequent tests.

Table 13: Summary of Flotation Results of Tests F-24 to F-26 at Various Primary Grinds

Test ID	F ₈₀ (µm)	Product	Wt %	Assays, % g/t									Distribution, %								
				Cu	Ni	S	Pt g/t	Pd g/t	Au g/t	Cp	Pn	Po	Cu	Ni	S	Pt	Pd	Au	Cp	Pn	Po
F-24	90	Cu/Ni Ro Conc 1-3	11.9	3.88	2.65	25.7	0.96	4.91	0.41	11.4	6.53	53.2	88.4	75.6	55.5	59.9	72.3	62.2	88.4	86.0	50.1
		Po Ro Conc 1-3	7.1	0.29	0.69	21.6	0.28	0.88	0.08	0.85	1.08	56.4	3.9	11.7	27.8	10.5	7.7	7.3	3.9	8.5	31.6
		Po Ro Tails	81.0	0.05	0.07	1.14	0.07	0.20	0.03	0.15	0.06	2.88	7.7	12.7	16.7	29.6	20.0	30.5	7.7	5.5	18.4
F-25	120	Cu/Ni Ro Conc 1-3	12.8	3.64	2.56	26.1	0.90	4.68	0.49	10.7	6.24	55.2	87.4	75.0	58.0	58.6	72.4	75.0	87.4	84.3	53.3
		Po Ro Conc 1-3	5.3	0.33	0.72	20.8	0.31	0.92	0.08	0.97	1.20	54.0	3.3	8.7	19.1	8.3	5.9	5.3	3.3	6.7	21.6
		Po Ro Tails	81.9	0.06	0.09	1.61	0.08	0.22	0.02	0.18	0.10	4.08	9.3	16.3	22.8	33.2	21.7	19.7	9.3	9.0	25.1
F-26	165	Cu/Ni Ro Conc 1-3	10.2	4.28	2.71	25.8	1.11	5.66	0.56	12.5	6.72	52.2	84.1	66.9	47.0	54.9	68.2	71.2	84.1	77.1	41.2
		Po Ro Conc 1-3	7.6	0.38	0.82	21.1	0.35	1.05	0.09	1.12	1.47	54.5	5.6	15.1	28.7	13.0	9.4	8.3	5.6	12.6	32.1
		Po Ro Tails	82.3	0.07	0.09	1.65	0.08	0.23	0.02	0.19	0.11	4.17	10.3	18.0	24.3	32.0	22.4	20.5	10.3	10.3	26.6

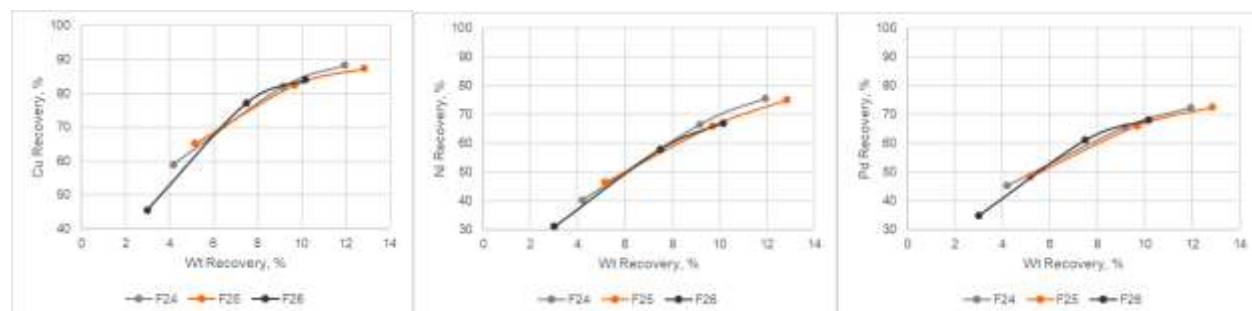
**Figure 12: Flotation Results of Tests F-24 to F-26**

4.2.2. Cleaner Flowsheet Development

The cleaner flowsheet was developed through tests F-30 to F-36, which included an investigation of the following factors:

- General cleaner flowsheet testing
- Depressant types and dosages
- Re grind size

The first cleaner kinetics test F-30 was based on the rougher conditions of test F-25, with the Cu/Ni rougher concentrate reground in a 2 kg rod mill, followed by a Cu/Ni cleaner and a cleaner scavenger-1 circuit. The Cu/Ni cleaner scavenger-1 tailings was reground in an attrition mill, followed by a Cu/Ni cleaner scavenger 2 stage. Test F-31 was similar to F-30, with the Cu/Ni cleaner scavenger-2 tailings being reground again in the attrition mill, followed by a Cu/Ni cleaner scavenger-3 stage. Test F-32 was similar to F-31, but a finer primary grind at F₈₀ of 90 µm was applied.

The additional one or two regrinds on the Cu/Ni cleaner scavenger-1 tailings contributed low additional copper and nickel recoveries, at 0.5-1% for copper or nickel at a grade of 1-2% Cu or Ni for each scavenger stage. The CAPEX and OPEX costs due to additional regrinds may not be justified based on these results.

A more notable issue was the low Cu/Ni grades in the Cu/Ni cleaner concentrate, at 7-9% Cu+Ni, despite the depressant addition of 10 g/t DETA in test F-30 and 60 g/t CMC in test F-32. To improve the grades of

Cu/Ni cleaner concentrate, the PAX dosage in the Cu/Ni rougher and the Cu/Ni cleaner were reduced by half to two thirds in tests F-33 to F-36, and the CMC dosage was reduced to 40 g/t. In test F-33, the Cu+Ni grades were considerably higher at 26% Cu+Ni. However, the nickel recovery was low at 39%. In test F-34, a higher dosage of DETA at 20 g/t was added to the Cu/Ni rougher concentrate regrind, the Cu+Ni grade was still low at 11%. In test F-35, the Cu/Ni regrind time was doubled to improve the pentlandite liberation and nickel recovery. The Cu+Ni grade in F-35 Cu/Ni 1st cleaner concentrate was ~20% with recoveries of 79% for copper and 55% for nickel.

Test F-36 was similar to F-35, but no DETA addition to the Cu/Ni cleaner and the addition of a Cu–Ni separation circuit. Without the addition of DETA, the Cu+Ni grade was lower but still acceptable, at 14%, with improved recoveries of 85% for copper and 63% for nickel. The Cu–Ni separation circuit was acceptable. A high-grade copper concentrate was produced, at 31% Cu, though the nickel content was slightly high at 1.7% Ni. The nickel grade in the Cu rougher scavenger tailings (nickel concentrate) was low, at 5% Ni, as would be expected from the 14% (Cu+Ni) Cu/Ni cleaner concentrate.

The regrind and cleaning of the Cu/Ni cleaner (scavenger) tailings and the Po rougher concentrate typically recovers 3-9% additional nickel at a grade of ~4% Ni, partially depending on the performance of the Cu/Ni cleaner circuit. The 10 g/t DETA addition instead of CMC in test F-34 was detrimental to nickel recovery and grade.

The addition of Po rougher 4 and 5 showed the potential of this sample to produce a low sulfur tailings (0.6% S).

The addition of Na₂S to the second increment of the Po 1st cleaner in test F-34 showed no beneficial effect on nickel grade or recovery.

Table 14: Summary of Test Conditions of F-30 to F-36

Test ID	Cu/Ni Ro			Po Ro	Cu/Ni Cleaners / Scavenger-1					Cu/Ni CI Scav-2			Cu/Ni CI Scav-3				Po Cleaners				
	F ₈₀ µm	MX900 g/t	PAX g/t	PAX g/t	P ₈₀ µm	DETA g/t	CMC g/t	MX900 g/t	PAX g/t	P ₈₀ µm	CMC g/t	PAX g/t	P ₈₀ µm	CMC g/t	MX900 g/t	PAX g/t	P ₈₀ µm	DETA g/t	CMC g/t	MX900 g/t	PAX g/t
F-30	120	12.5	10	-	RG	10	-	2.5 / 2.5	5 / 5	17	-	3	-	-	-	-	-	-	-	-	-
F-31	120	12.5	10	-	40	-	-	1.25 / 2.5	3 / 5	22	-	3	16	-	-	3	-	-	-	-	-
F-32	90	12.5	10	30	RG	-	60	1.25	3	RG	40	1	15	20	2.5	1	-	-	-	-	
F-33	90	12.5	5	30	RG	-	40	0 / 2.5	1	-	-	-	-	-	-	-	28.5*	-	40	2.5	1
F-34*	90	12.5	5	30	RG	20	30	0 / 2.5	1	-	-	-	-	-	-	-	18.7	10	-	2.5	4
F-35	90	12.5	5	60	30	20	30	0 / 2.5	1	-	-	-	-	-	-	-	23.0*	-	40	2.5	2
F-36*	90	12.5	5	60	30	-	30	0 / 2.5	1	-	-	-	-	-	-	-	RG	-	40	2.5	2

* S/A on CI Tails

RG = Re grind was performed, but the particle size of re grind product was not measured

*Test F-34 includes a Po Ro 4 and Po Ro 5 stages. Po Ro 4: 20g/t PAX, 50g/t CuSO₄; Po Ro 5 - Mag Sep; Added 30g/t Na₂S to Po cleaner

*Test F-36 includes a Cu - Ni Separation stage on the Cu/Ni 1st Cleaner Concentrate, Conditions: Polish grind by Pebble Mill for 2.5 minutes with 325 g/t lime and 1 g/t PAX

Table 15: Results Summary of Flotation Tests F-30 to F-36

Test ID	Product	Wt %	Assays, %									Distribution, %								
			Cu	Ni	S	Pt g/t	Pd g/t	Au g/t	Cp	Pn	Po	Cu	Ni	S	Pt	Pd	Au	Cp	Pn	Po
F-30	Cu/Ni 1st Cl Conc 1-3	9.5	4.75	3.24	33.4	1.2	6.1	0.5	13.9	7.9	70.4	87.9	74.4	53.6	52.0	70.0	60.6	87.9	85.8	48.5
	Cu/Ni 1st Cl & Scav1 Conc	9.9	4.60	3.15	33.4	1.1	5.9	0.5	13.5	7.7	70.9	88.0	75.1	55.4	52.4	70.3	61.1	88.0	86.2	50.5
	Cu/Ni Cl Scav2 Conc	0.4	0.52	0.44	10.5	0.7	1.4	0.4	1.53	0.8	26.3	0.4	0.5	0.8	1.5	0.7	2.3	0.4	0.4	0.8
	Cu/Ni Ro Conc 1-3	15.0	3.06	2.14	23.8	0.8	4.0	0.3	9.0	5.1	51.3	89.1	77.5	60.0	56.3	72.4	65.9	89.1	87.8	55.6
	Cu/Ni Ro Tails	85.0	0.07	0.11	2.80	0.1	0.3	0.0	0.2	0.1	7.2	10.9	22.5	40.0	43.7	27.6	34.1	10.9	12.2	44.4
F-31	Cu/Ni 1st Cl Conc 1-3	8.1	5.65	3.69	34.2	1.4	6.6	1.7	16.6	9.2	69.0	87.4	69.7	48.2	55.6	67.3	79.6	87.4	80.4	42.2
	Cu/Ni 1st Cl & Scav1 Conc	8.6	5.31	3.53	34.1	1.3	6.2	1.6	15.6	8.7	70.2	87.8	71.2	51.5	56.4	68.0	80.0	87.8	81.6	45.9
	Cu/Ni Cl Scav2 Conc	0.6	0.56	0.86	20.4	0.6	1.4	0.8	1.6	1.6	52.0	0.6	1.2	2.1	1.8	1.1	2.8	0.6	1.0	2.3
	Cu/Ni Cl Scav3 Conc	0.5	0.37	0.59	13.5	0.4	0.9	0.2	1.1	1.1	34.4	0.4	0.7	1.2	1.0	0.6	0.7	0.4	0.6	1.3
	Cu/Ni Ro Conc 1-3	9.5	4.87	3.28	32.6	1.3	5.8	1.5	14.3	8.1	67.9	88.6	72.8	54.2	58.9	69.4	83.3	88.6	82.9	48.9
Cu/Ni Ro Tails	85.8	0.06	0.12	2.60	0.1	0.3	0.0	0.2	0.2	6.7	10.2	24.2	39.1	38.1	28.4	15.4	10.2	15.0	43.6	
F-32	Cu/Ni 1st Cl Conc 1-3	11.5	3.90	2.85	33.4	1.1	5.3	0.6	11.4	6.8	73.5	89.4	80.3	70.1	63.9	74.9	67.9	89.4	89.2	67.0
	Cu/Ni Cl Scav2 Conc	0.2	1.51	1.72	21.6	1.5	4.0	0.6	4.4	4.0	50.6	0.5	0.7	0.7	1.3	0.9	1.1	0.5	0.8	0.7
	Cu/Ni Cl Scav3 Conc	0.3	1.30	1.09	11.4	1.0	3.8	0.5	3.8	2.6	25.0	0.8	0.8	0.6	1.5	1.4	1.5	0.8	0.9	0.6
	Cu/Ni Ro Conc 1-3	18.5	2.51	1.89	23.3	0.7	3.5	0.4	7.4	4.4	52.2	92.4	85.7	78.6	70.7	80.0	74.6	92.4	93.7	76.3
	Po Ro Tails	81.5	0.05	0.07	1.44	0.1	0.2	0.0	0.1	0.1	3.7	7.6	14.3	21.4	29.3	20.0	25.4	7.6	6.3	23.7
F-33	Cu/Ni 2nd Cl Conc	2.3	19.1	6.96	28.9	3.8	21.1	1.9	56.0	19.0	10.6	80.3	38.3	11.7	38.6	57.7	49.1	80.3	48.5	1.9
	Cu/Ni 1st Cl Conc	3.1	14.7	6.63	29.2	3.1	16.7	1.5	43.0	17.9	24.3	82.6	48.9	15.8	42.2	61.1	52.3	82.6	61.3	5.7
	Po 1st Cl Conc	0.9	1.78	4.06	33.8	1.8	5.0	0.6	5.2	10.1	77.6	3.1	9.2	5.6	7.4	5.6	6.1	3.1	10.6	5.6
	Po Ro Tails	84.6	0.06	0.10	2.16	0.1	0.2	0.0	0.2	0.1	5.6	8.7	20.0	32.4	37.8	22.3	29.2	8.7	10.9	36.3
F-34	Cu/Ni 1st Cl Conc	6.5	6.79	4.32	34.1	1.5	8.2	1.0	19.9	11.0	64.2	83.3	66.5	40.1	45.0	64.3	64.6	83.3	77.9	33.0
	Po 1st Cl Conc	0.8	0.86	1.39	27.0	0.8	2.3	0.2	2.5	2.9	67.9	1.3	2.7	4.0	3.1	2.3	1.7	1.3	2.6	4.4
	Po Ro Conc -4	1.7	0.17	0.57	21.6	0.3	0.6	0.1	0.5	0.7	57.0	0.6	2.4	6.8	2.2	1.2	1.0	0.6	1.4	7.9
	Po Ro Conc -5	1.4	0.06	0.35	13.5	0.2	0.4	0.1	0.2	0.4	35.8	0.1	1.1	3.3	1.1	0.7	0.7	0.1	0.6	3.9
	Po Ro Tails	78.2	0.05	0.06	0.56	0.1	0.2	0.0	0.1	0.1	1.3	7.6	10.8	8.0	36.0	20.8	22.8	7.6	5.2	8.2
F-35	Cu/Ni 1st Cl Conc	3.4	12.7	7.05	33.8	2.7	15.9	2.5	37.2	18.8	41.0	78.5	55.0	20.2	43.7	63.0	66.0	78.5	67.5	10.7
	Po 1st Cl Conc	1.3	1.52	2.77	32.9	1.5	4.0	0.4	4.5	6.5	78.9	3.6	8.3	7.6	9.5	6.1	4.5	3.6	9.0	8.0
	Po Ro Tails	80.9	0.06	0.07	1.34	0.1	0.2	0.0	0.2	0.1	3.4	9.5	13.2	19.3	30.9	19.1	19.3	9.5	5.8	21.3
F-36	Cu 2nd Cl Conc	0.7	30.7	1.67	34.4	4.0	34.6	4.0	90.0	4.5	6.6	44.2	2.9	4.6	14.5	31.7	21.9	44.2	3.6	0.4
	Cu 1st Cl Conc	1.1	27.4	3.49	33.8	3.9	31.0	5.1	80.3	9.5	9.5	57.8	8.8	6.6	20.5	41.6	40.3	57.8	11.0	0.8
	Cu Ro Conc	1.7	21.1	5.54	33.1	3.6	24.6	4.0	61.8	14.9	20.0	70.0	22.1	10.3	29.6	52.0	49.7	70.0	27.4	2.7
	Cu Ro & Scav Conc	1.9	20.1	5.91	33.0	3.5	23.6	4.2	59.1	15.9	21.4	74.8	26.3	11.4	33.0	55.7	59.3	74.8	32.6	3.2
	Cu Ro Scav Tails	3.0	1.71	5.11	32.8	1.2	3.1	0.3	5.0	13.0	72.6	10.1	36.2	18.1	18.3	11.6	6.9	10.1	42.4	17.4
	Cu/Ni 1st Cl Conc	4.9	8.83	5.42	32.9	2.1	11.0	1.8	25.9	14.2	52.8	84.9	62.5	29.5	51.3	67.3	66.2	84.9	75.0	20.6
	Po 2nd Cl Conc	0.5	1.72	3.19	35.1	2.2	5.6	0.6	5.0	7.6	83.3	1.7	3.7	3.2	5.3	3.5	2.0	1.7	4.1	3.3
Po Ro Tails	76.9	0.04	0.06	0.57	0.1	0.2	0.0	0.1	0.1	1.4	6.5	10.1	8.0	26.5	17.3	22.8	6.5	4.5	8.4	

4.3. Flowsheet Evaluation with HG Comp

Three batch flotation tests (F-27, F-38, and F-40) were performed on the HG Comp, to evaluate the flowsheet developed for the LG Comp. A summary of testing conditions is presented in Table 16 and results are presented in Table 17.

The key findings from these tests are summarized as follows:

- The rougher kinetics test (F-27) at a F_{80} of 87 μm was similar to the typical rougher kinetics test (F-24, F-25) of the LG Comp, with a bit lower nickel recovery (71%) and similar copper recovery (88%) in the Cu/Ni Rougher Concentrate 1-3. The Po rougher concentrate 1-3 recovered an additional 5% copper and 19% nickel at low grade (0.2% Cu and 0.9% Ni).
- Test F-38 evaluated the flowsheet similar to test F-36. The final copper concentrate contained a reasonably good copper grade, at 29% Cu, but a high nickel content of 3.3% Ni. It is possible that the MaxGold 900 and PAX were over-dosed in the Cu/Ni circuit, similar to what observed in test F-36. The nickel grade in the nickel concentrate (Cu rougher scavenger tailings) was low, at 6% Ni.
- Test F-40 was performed following the conditions used in LCT-4 and LCT-5, with a significantly lower dosage of MaxGold 900 and PAX. A high-grade copper concentrate (33% Cu) with low nickel content (0.4%Ni) was produced. The nickel grade in the Cu Rougher Scavenger Tailings was still below the target at 7.6% Ni. Pyrrhotite was the main gangue mineral with an estimated content of 72% Po. It is recommended to perform a mineralogical analysis of the Cu/Ni 1st Cleaner Concentrate to analyze the liberation and association characteristics of pentlandite and pyrrhotite. Depending on the mineralogical findings, future testing to improve the pentlandite liberation or depress pyrrhotite may include a finer Cu/Ni regrind, further decreasing MaxGold 900 dosages, and addition of DETA to the Cu/Ni regrind.

Table 16: Summary of Testing Conditions of F-27, F-38, and F-40

Test ID	Cu/Ni Ro			Po Ro	Cu/Ni Cleaners / Scavenger				Po Cleaners				Cu - Ni Separation			
	F_{80} μm	MX900 g/t	PAX g/t	PAX g/t	P_{80} μm	CMC g/t	MX900 g/t	PAX g/t	P_{80} μm	CMC g/t	MX900 g/t	PAX g/t	Polish Grind, min	Lime in Grind g/t	PAX g/t	pH
F-27	87	15	10	30	-	-	-	-	-	-	-	-	-	-		
F-38	87	12.5	5	60	29	30	0 / 2.5	1 / 1	27	40	2.5	1	4	400	2	11.7
F-40	87	5	10	30	RG	30	0	1 / 2	20	40	0	3	4	400	1	11.6

RG = Regrind was performed, but the particle size of regrind product was not measured

Table 17: Results Summary of Tests F-27, F-38, and F-40 (HG Comp)

Test ID	Product	Wt %	Assays, %									Distribution, %								
			Cu	Ni	S	Pt g/t	Pd g/t	Au g/t	Cp	Pn	Po	Cu	Ni	S	Pt	Pd	Au	Cp	Pn	Po
F-27	Cu/Ni Ro Conc 1-3	14.5	4.04	3.61	30.1	4.04	3.61	30.1	11.9	9.05	62.6	87.6	71.0	42.1	66.7	77.2	78.2	87.6	80.6	36.7
	Po Ro Conc 1-3	14.7	0.24	0.93	28.7	0.24	0.93	28.7	0.70	1.49	75.3	5.2	18.5	40.7	13.7	8.5	8.9	5.2	13.5	44.7
	Po Ro Tails	70.8	0.07	0.11	2.52	0.09	0.26	0.02	0.20	0.14	6.48	7.2	10.6	17.2	19.6	14.4	13.0	7.2	5.9	18.6
F-38	Cu 2nd Cl Conc	1.1	28.7	3.29	34.7	3.76	51.4	4.14	84.2	8.92	9.03	48.7	5.0	3.9	13.2	42.6	31.8	48.7	6.2	0.4
	Cu Ro Scav Tails	4.0	1.84	6.20	34.3	1.81	3.69	0.28	5.40	16.0	73.7	11.2	33.9	13.8	22.7	10.9	7.7	11.2	39.5	12.5
	Cu/Ni 1st Cl Conc	6.7	8.32	6.53	34.2	2.46	14.8	1.50	24.4	17.2	55.2	84.5	59.9	23.1	51.8	73.3	68.9	84.5	70.9	15.7
	Po 2nd Cl Conc	1.3	0.65	2.66	36.8	1.88	2.86	1.16	1.91	6.04	92.1	1.2	4.6	4.7	7.4	2.7	10.0	1.2	4.7	4.9
	Po Ro Tails	64.4	0.06	0.07	0.78	0.09	0.25	0.02	0.17	0.07	1.88	5.6	5.8	5.1	18.3	11.9	8.9	5.6	3.0	5.2
F-40	Cu 3rd Cl Conc	0.6	33.0	0.42	34.6	2.51	60.8	4.53	96.8	1.10	3.89	31.8	0.3	2.1	4.6	28.6	13.3	31.8	0.4	0.1
	Cu Ro Scav Tails	4.5	2.22	7.58	35.2	2.28	4.42	0.66	6.51	19.8	71.9	15.7	46.3	15.7	30.5	15.3	14.3	15.7	54.6	13.5
	Cu/Ni 1st Cl Conc	6.4	8.27	6.68	34.8	2.61	14.5	2.55	24.3	17.6	56.6	82.7	57.8	22.0	49.5	70.9	78.0	82.7	68.5	15.0
	Po 3rd Cl Conc-1	1.1	1.51	3.99	37.3	2.68	4.37	0.47	4.43	9.75	88.0	2.6	6.0	4.1	8.9	3.7	2.5	2.6	6.7	4.1
	Po Ro Tails	63.4	0.05	0.07	0.74	0.09	0.24	0.03	0.15	0.08	1.78	5.0	5.9	4.6	16.8	11.6	9.0	5.0	3.2	4.7
	Head (Dir.)		0.66	0.77	10.5	0.37	1.28	0.08	1.94	1.71	25.0									

4.4. Locked Cycle Testing

A total of two locked cycle tests (LCT) were completed. One locked cycle test (LCT-4) with six cycles was completed on 2 kg test charges of the LG Comp sample, included the Cu/Ni Roughers, Po Roughers, Cu/Ni Cleaners, and Po Cleaners stages. The second locked cycle tests (LCT-5) with five cycles evaluated the Cu-Ni separation stages using the Cu/Ni Cleaner Concentrate generated from LCT-4.

Once the Cu/Ni Cleaner Concentrate was produced in each cycle, it was filtered, the total wet weight was recorded, and then subsampled for assay. The remaining samples were repulped and stored in a refrigerator until ready for use.

The combined pulp from the LCT-4 Cu/Ni cleaner concentrates was then filtered, blended, and split into five equal charge weights of ~65 g dry equivalent as feed for LCT-5 testing. The moisture content of the Cu/Ni Cleaner Concentrate was calculated based on the total dry weights of LCT-5 products, at 11.6%. The same moisture content was assumed for Cu/Ni Cleaner Concentrate of each cycle and the dry weight was estimated for mass balance calculations.

The flowsheet for both LCTs was based on the conditions of test F-36 with minor adjustments. In LCT-4 testing, only 5 g/t of MaxGold 900 was added to the primary grind, and no further addition in the remainder of the circuits. The PAX dosage was decreased to half (10 g/t each addition) in the Po Rougher circuits. The decision was made due to concerns that too much collector was added into the flotation circuit in test F-36, causing the low nickel grade in the final nickel concentrate (Cu Rougher Scavenger Tailings) as well as the high nickel content in the copper final concentrate. Table 18 summarizes the typical test conditions used for LCT-4 and LCT-5.

Table 18: Summary of Test Conditions for LCT-4 and LCT-5

Cu/Ni Ro			Po Ro	Po Ro Scavenge		Cu/Ni Cleaners / Scavenger			Po Cleaners			Cu - Ni Separation			
F ₈₀ µm	MX900 g/t	PAX g/t	PAX g/t	PAX g/t	CuSO ₄ g/t	P ₈₀ µm	CMC g/t	PAX g/t	P ₈₀ µm	CMC g/t	PAX g/t	Polish Grind, min	Lime in Grind g/t	PAX g/t	pH
90	5	10	30	30	50	~25	30	1-2 / 2	~15	40	3	2.5	250	0.5+0.5	~11.5

The flowsheets for LCT-4 and LCT-5 are illustrated in Figure 13 and Figure 14, respectively.

Details of the LCT-4 and LCT-5 test conditions and test results are provided in Appendix D.

4.4.1. LCT-4 Test Results

A stability check was performed for each locked cycle tests based on the metal units in the exit streams of each cycle as a percentage of the units in the feed to each cycle. The stability of LCT-4 was reasonably good starting at cycle C. Following a statistical analysis, cycles C to F for LCT-4 were deemed to be suitable

for projected mass balance calculations, to simulate the metallurgical performance that would be achieved in a continuous operation. This is presented in Table 19.

The projected Cu/Ni 1st Cleaner Concentrate graded ~20% Cu + Ni, with 82% copper recovery and 53% nickel recovery. The nickel recovery to the Po 3rd Cleaner Concentrate was 10%, with a good grade, at 10% Ni. The grades in both Cu/Ni 1st Cleaner Concentrate and Po 3rd Cleaner Concentrate were higher than what was typically observed in the batch flotation tests. Although the nickel recovery in the Cu/Ni 1st Cleaner Concentrate was low compared to F-36, the Po 3rd Cleaner Concentrate compensated for this and the combined recovery from the two concentrates was similar to F-36. The reduction of collector dosages in the flotation circuit and possibly the slightly finer regrind size may have contributed to the improved grades.

The combined Cu/Ni 1st Cleaner Concentrate and the Po 3rd cleaner concentrate accounted for 86% copper and 63% nickel recoveries, grading ~19% Cu+Ni.

4.4.2. LCT-5 Test Results

Following a statistical analysis, cycles B to E for LCT-5 were deemed to be suitable for projected mass balance calculations, to simulate the metallurgical performance that would be achieved in a continuous operation. The projected metallurgical results are presented in Table 20.

The projected metallurgical results showed the stage recovery of copper to the copper concentrate was 67% at a grade of 33% Cu and 0.3% Ni, with the residual 33% deporting to the nickel concentrate. The nickel stage recovery to the nickel concentrate (Cu Rougher Scavenger Tails) was 99% at a grade of ~10% Ni. The quality of the two concentrates were much better than what typical batch flotation tests achieved. The reduction of collector from the beginning of LCT-4 flotation likely contributed to this. It is possible that the copper recovery could be improved with a bit more collector addition to the Cu Rougher flotation circuit.

4.4.3. LCT-4 and LCT-5 Combined Results

The combined results of LCT-4 and LCT-5 are presented in Table 21. The overall copper recovery to the Cu 3rd Cleaner Concentrate was 55% at a grade of 33% Cu and 0.3% Ni. The overall nickel recovery of the combined Cu Rougher Scavenger Tailings and the Po 3rd Cleaner Concentrate was 63% at a grade of 10% Ni and 6% Cu.

Platinum group elements (PGE) were successfully recovered to the copper and nickel concentrates. The combined recoveries ranging from 55% to 75%. The palladium was well-concentrated in the copper concentrate, grading 36 g/t Pd, and reasonably good grade in the nickel concentrate, at 9 g/t Pd. The grades of platinum and gold in the copper or nickel concentrates ranged from ~2 g/t to 5 g/t Pt/Au.

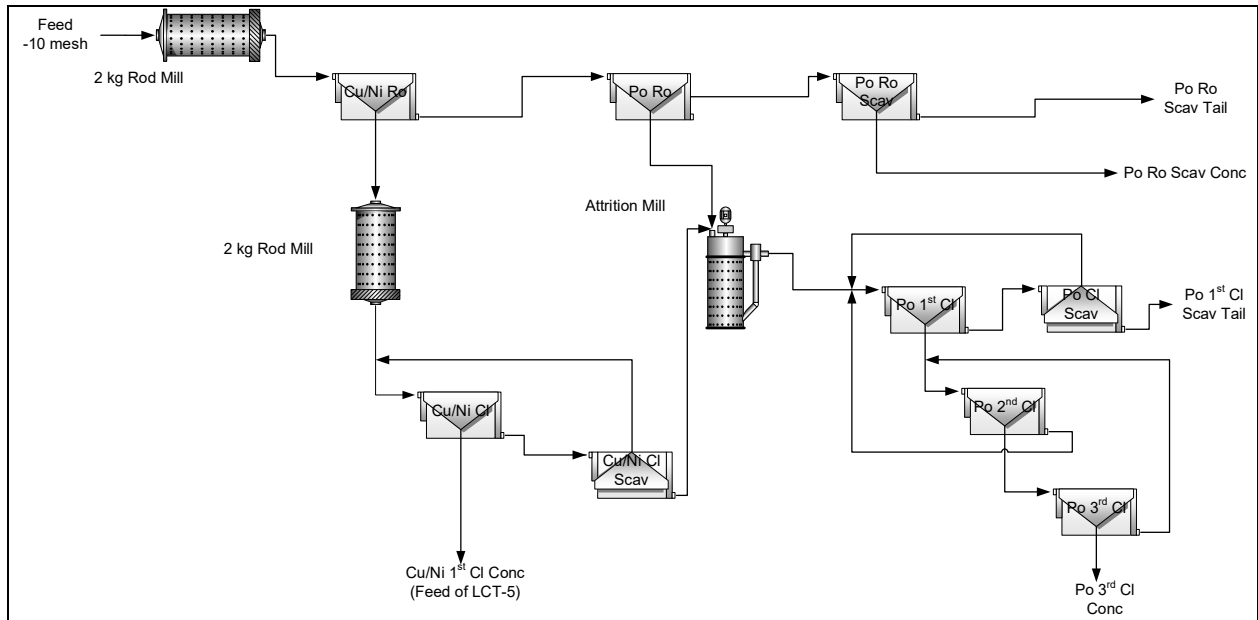

Figure 13: Flowsheet of LCT-4

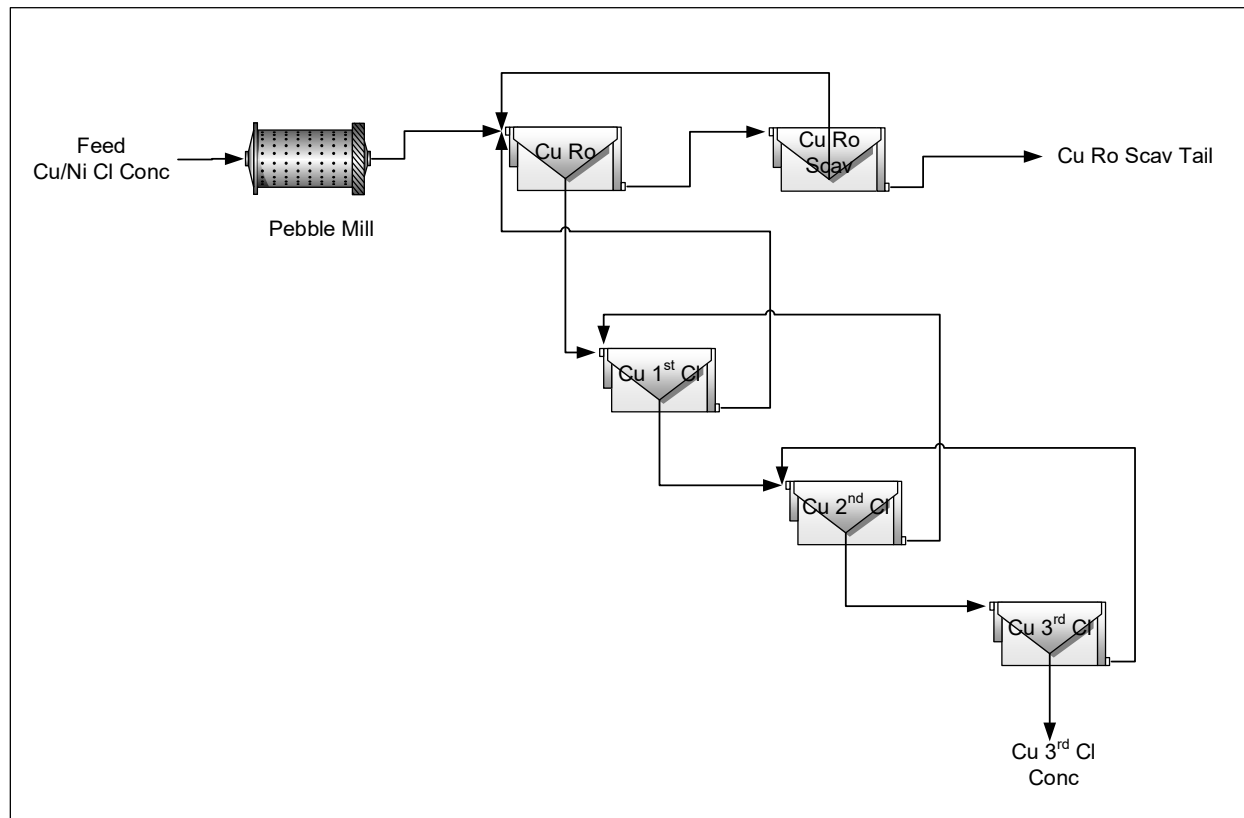

Figure 14: Flowsheet of LCT-5

Table 19: LCT-4 Metallurgical Projection (C-F)

Product	Weight %	Assays, %, g/t										% Distribution							
		Cu	Ni	S	Pt, g/t	Pd, g/t	Au, g/t	Cp	Pn	Po	Cu	Ni	S	Pt	Pd	Au	Cp	Pn	Po
Cu/Ni 1st CI Conc	3.2	12.5	7.39	33.7	3.10	16.0	2.58	36.8	19.7	45.3	81.7	52.9	18.8	43.4	61.7	68.9	81.7	64.8	9.7
Po 3rd CI Conc	0.4	5.01	10.4	36.3	5.89	14.4	1.50	14.7	27.8	57.9	4.5	10.4	2.8	11.4	7.7	5.5	4.5	12.7	2.0
Combined Cu/Ni Conc	3.6	11.7	7.79	34.1	3.45	15.9	2.46	34.2	20.8	43.0	86.2	63.2	21.6	54.8	69.4	74.4	86.2	77.4	11.7
Po 1st CI Tails	13.3	0.20	0.74	22.5	0.23	0.57	0.06	0.58	1.20	58.9	5.4	22.3	52.5	13.7	9.1	7.0	5.4	16.5	59.4
Po Ro Scav Conc	4.0	0.12	0.52	25.0	0.25	0.54	0.06	0.34	0.50	69.0	1.0	4.8	17.8	4.5	2.6	2.1	1.0	2.1	20.4
Po Rougher Tail	79.1	0.05	0.05	0.59	0.08	0.20	0.02	0.13	0.05	1.45	7.4	9.7	8.2	27.0	18.9	16.6	7.4	4.0	8.5
Head (Calc.)	100	0.49	0.44	5.72	0.23	0.83	0.12	1.43	0.97	13.2	100	100	100	100	100	100	100	100	100
Head (Dir.)		0.55	0.44	5.76	0.18	0.82	0.07	1.61	0.96	13.2									

Table 20: LCT-5 Metallurgical Projection (B-E) – Stage Performance

Product	Weight %	Assays, %										% Distribution							
		Cu	Ni	S	Pt, g/t	Pd, g/t	Au, g/t	Cp	Pn	Po	Cu	Ni	S	Pt	Pd	Au	Cp	Pn	Po
Cu 3rd CI Conc	29.1	33.2	0.32	34.4	1.69	39.9	3.33	97.3	0.83	3.10	66.8	1.3	30.5	16.8	64.9	56.4	66.8	1.3	2.7
Cu Ro Scav Tail	70.9	6.75	9.78	32.1	3.43	8.82	1.06	19.8	26.2	46.0	33.2	98.7	69.5	83.2	35.1	43.6	33.2	98.7	97.3
Cu/Ni CI Conc (Calc.)	100	14.4	7.03	32.8	2.92	17.9	1.72	42.3	18.9	33.6	100	100	100	100	100	100	100	100	100

Table 21: Combined LCT-4 and LCT-5 Results

Product	Weight %	Assays, %, g/t										% Distribution							
		Cu	Ni	S	Pt, g/t	Pd, g/t	Au, g/t	Cp	Pn	Po	Cu	Ni	S	Pt	Pd	Au	Cp	Pn	Po
Cu 3rd CI Conc	0.9	33.2	0.32	34.4	1.79	36.0	5.03	84.8	0.88	3.74	54.6	0.7	5.7	7.3	40.1	38.8	54.6	0.8	0.3
Cu Ro Scav Tail	2.3	5.88	10.3	33.1	3.65	7.96	1.59	17.3	27.6	55.5	27.1	52.2	13.0	36.1	21.6	30.0	27.1	63.9	9.4
Po 3rd CI Conc	0.4	5.03	10.5	36.5	5.91	14.4	1.50	14.7	27.9	60.9	4.5	10.4	2.8	11.4	7.7	5.5	4.5	12.7	2.0
Po 1st CI Tails	13.3	0.20	0.75	22.6	0.23	0.57	0.06	0.58	1.20	59.2	5.4	22.3	52.5	13.7	9.1	7.0	5.4	16.5	59.4
Po Ro Scav Conc	4.0	0.12	0.53	25.1	0.25	0.54	0.06	0.34	0.50	66.8	1.0	4.8	17.8	4.5	2.6	2.1	1.0	2.1	20.4
Po Rougher Tail	79.1	0.05	0.05	0.59	0.08	0.20	0.03	0.13	0.05	1.42	7.4	9.7	8.2	27.0	18.9	16.6	7.4	4.0	8.5
Comb. Ni Conc (Cu Ro Scav Tails + Po 3rd CI Conc)	2.7	5.74	10.3	33.7	4.02	9.0	1.58	16.8	27.6	56.4	31.6	62.5	15.8	47.5	29.3	35.6	31.6	76.6	11.5
Head (Calc.)	100	0.49	0.44	5.72	0.23	0.83	0.12	1.43	0.97	13.2	100	100	100	100	100	100	100	100	100
Head (Dir.)		0.55	0.44	5.76	0.18	0.82	0.07	1.61	0.96	13.2									

4.5. Detailed Concentrate Assays

Concentrates from LCT-5 were submitted for a typical smelter analysis suite of elements as summarized in Table 22. The concentrates from cycles B to E (deemed to be the steady state cycles) were combined and submitted for assay.

The cobalt seemed to follow the nickel (likely pentlandite), with a grade of 0.64% Co in the Cu Rougher Scavenger Tails. The Po 3rd Cleaner Concentrates cycles C to F from LCT-4 were submitted for cobalt analysis. The average cobalt content was 0.67% Co. The cobalt content in the Cu 3rd Cleaner Concentrate was 176 g/t Co. No obvious deleterious elements were present.

Table 22: Detailed Analysis on LCT-5 Products

Analyte	Unit	LCT-5 Cu 3rd CI Conc B-E	LCT-5 Cu Ro Scav Tails B-E
Cu	%	33.5	6.57
Ni	%	0.34	10.0
S	%	33.8	32.5
Au	g/t	2.90	1.06
Pt	g/t	1.85	3.58
Pd	g/t	41.6	8.78
Rh	g/t	0.08	0.12
Hg	g/t	< 3	< 3
Ag	g/t	72	48
Al	g/t	1010	10900
As	g/t	< 30	< 30
Ba	g/t	4	11
Bi	g/t	< 50	< 50
Ca	g/t	2160	13900
Cd	g/t	41	22
Co	g/t	176	6370
Cr	g/t	< 10	267
Fe	g/t	366000	405000
K	g/t	< 200	< 200
Li	g/t	< 20	< 20
Mg	g/t	524	5760
Mn	g/t	20	157
Mo	g/t	< 10	< 10
Na	g/t	243	985
P	g/t	< 200	< 200
Pb	%	0.016	0.021
Rb	%	< 0.002	< 0.002
Sb	g/t	48	76
Se	g/t	66	64
Sn	g/t	< 20	< 20
Sr	g/t	2.4	13.1
Ti	g/t	28	135
Tl	g/t	< 40	< 40
U	g/t	< 100	< 100
V	g/t	< 20	< 20
Y	g/t	< 0.5	< 0.5
Zn	g/t	1340	777
Te	g/t	91	31
F	%	0.030	0.026
Cl (HNO ₃ soluble)	g/t	18	22
Si	%	0.21	1.95
Hg	g/t	< 3	< 3

Conclusions and Recommendations

The following can be concluded:

- The Selkirk samples received for this testwork program contained 0.55% Cu and 0.44% Ni in the LG Comp and higher grades in the HG Comp (0.66% Cu, 0.77% Ni).
- Mineralogy showed that chalcopyrite, pentlandite, and pyrrhotite were the major sulphide minerals, along with trace amounts of pyrite. The HG Comp contained about double the pyrrhotite content compared to that in the LG Comp.
- Liberation of the chalcopyrite was reasonably good for both composites, with 74-83% free at a K80 of ~100-130 µm. But, liberation of the pentlandite was poor for both samples, at ~46-55% with strong associations with pyrrhotite. A fine regrind (~15 µm) is required to liberate pentlandite for maximizing nickel grade and recovery.
- The proportion of total nickel in pentlandite was ~84-87%, with the majority of the remaining nickel contained in pyrrhotite, and minor amounts hosted in the silicate gangue minerals.
- The grindability tests indicated the Selkirk samples were moderately hard to very hard, and medium abrasiveness.
- The rougher kinetics performance of the LG Comp at a primary grind F80 of ~120 µm was similar to those at 90 µm and slightly better than a coarser grind at 165 µm. The primary grind size at a P80 of 120 µm was used for the beginning of cleaner flowsheet evaluation, but in later tests it was shifted to 90 µm.
- A fine regrind (~25 µm) was critical for achieving good Cu+Ni grade of the Cu/Ni 1st cleaner concentrate.
- Over-dosing MaxGold 900 and / or PAX in the rougher and Cu/Ni cleaner stages appeared to deteriorate the quality of the final concentrates and careful control of collector dosages is recommended.
- DETA is not required for Selkirk samples to achieve the target nickel concentrate grade.
- The recovery of copper to the Cu concentrate was found to be 55% at a grade of 33% Cu and 0.3% Ni, with an additional 27% copper recovered to the Ni concentrate. The nickel recovery to the final Ni concentrate (combined Copper Rougher Scavenger Tails and Po 3rd Cleaner Concentrate) was 63% at a grade of 10% Ni.

Recommendations:

- Further flowsheet and reagent optimization should be completed to better establish the limits to metallurgy. More representative samples should be provided for this testwork.
 - Batch flotation tests to improve the copper recovery in the Cu-Ni separation stages should be performed, by increasing the PAX dosage or residence time slightly.
 - MaxGold 900 is a strong collector. The flotation performance should be evaluated without MaxGold 900 in the flowsheet. PGE recoveries should be monitored.
- Variability testing should be further investigated.
 - Hardness characteristics as a function of sulphur head grade should be examined.
 - The nickel grade in the nickel concentrate (Cu Rougher Scavenger Tailings and Po 3rd Cleaner Concentrate) of HG Comp was still below the target. Mineralogical analysis to understand the liberation and association of pentlandite and pyrrhotite in these products is recommended. Based on the outcome of the mineralogy results, batch flotation tests to improve the pentlandite liberation and / or depress the pyrrhotite are recommended, such as a finer regrind, reduced collector dosage, and possible addition of DETA.
 - Flotation evaluation of varying head grades to better understand grade-recovery relationships and dosing strategies for reagents, which will be critical the successful operation of a future commercial processing plant.
- Perform pilot plant testing to confirm the metallurgy in a continuous operation.
- Environmental testing in support of a tailings management plan.
- Solid-liquid separation testing on various streams to help size thickeners, pumps, and filters.

Appendix A – Sample Receipt and Preparation

18559-01

29-Jul-21

Sample Preparation Diagram - LG Comp

Note: No hazards that are known, other than silica

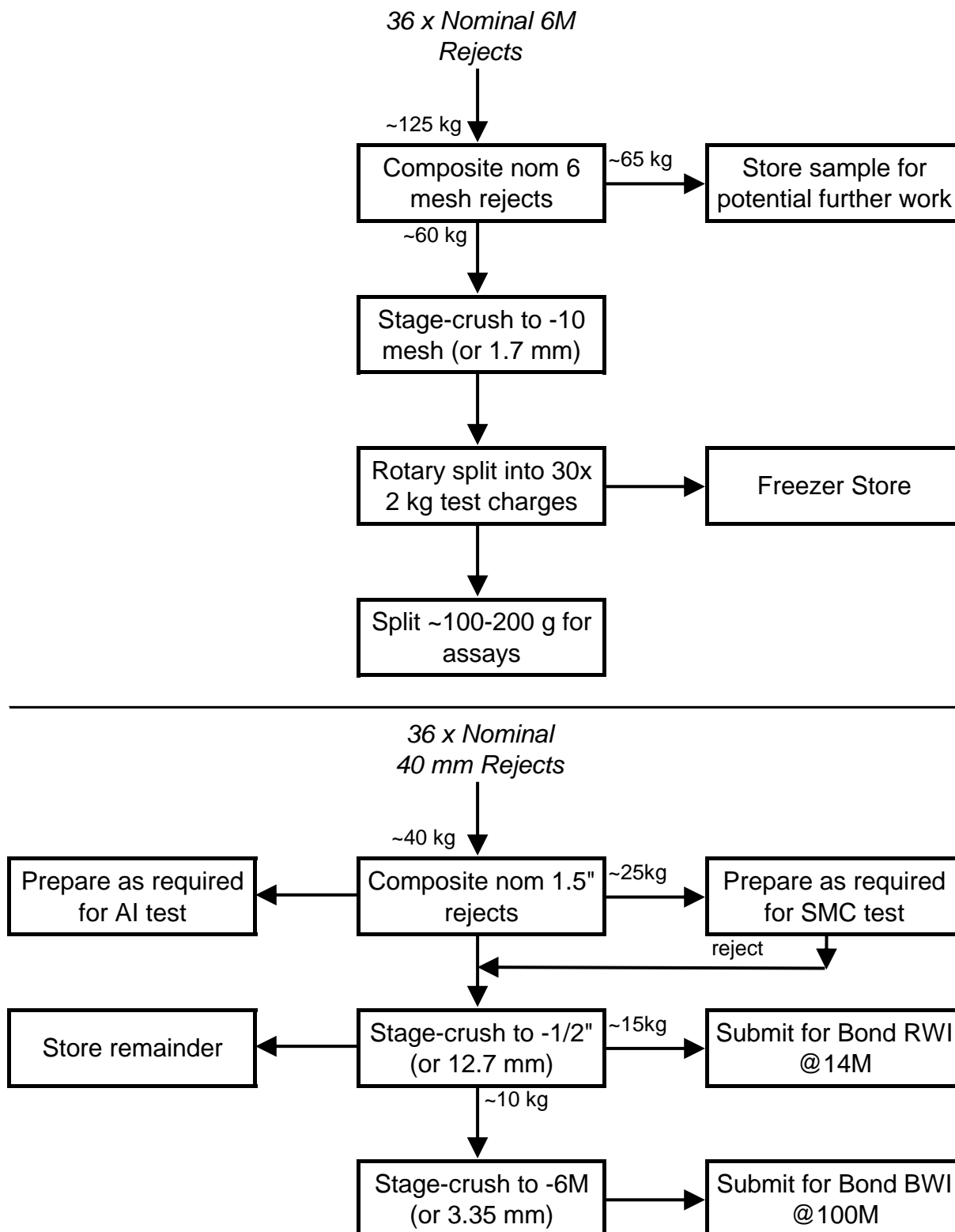

18559-01

29-Jul-21

Sample Preparation Diagram - HG Comp

Note: No hazards that are known, other than silica

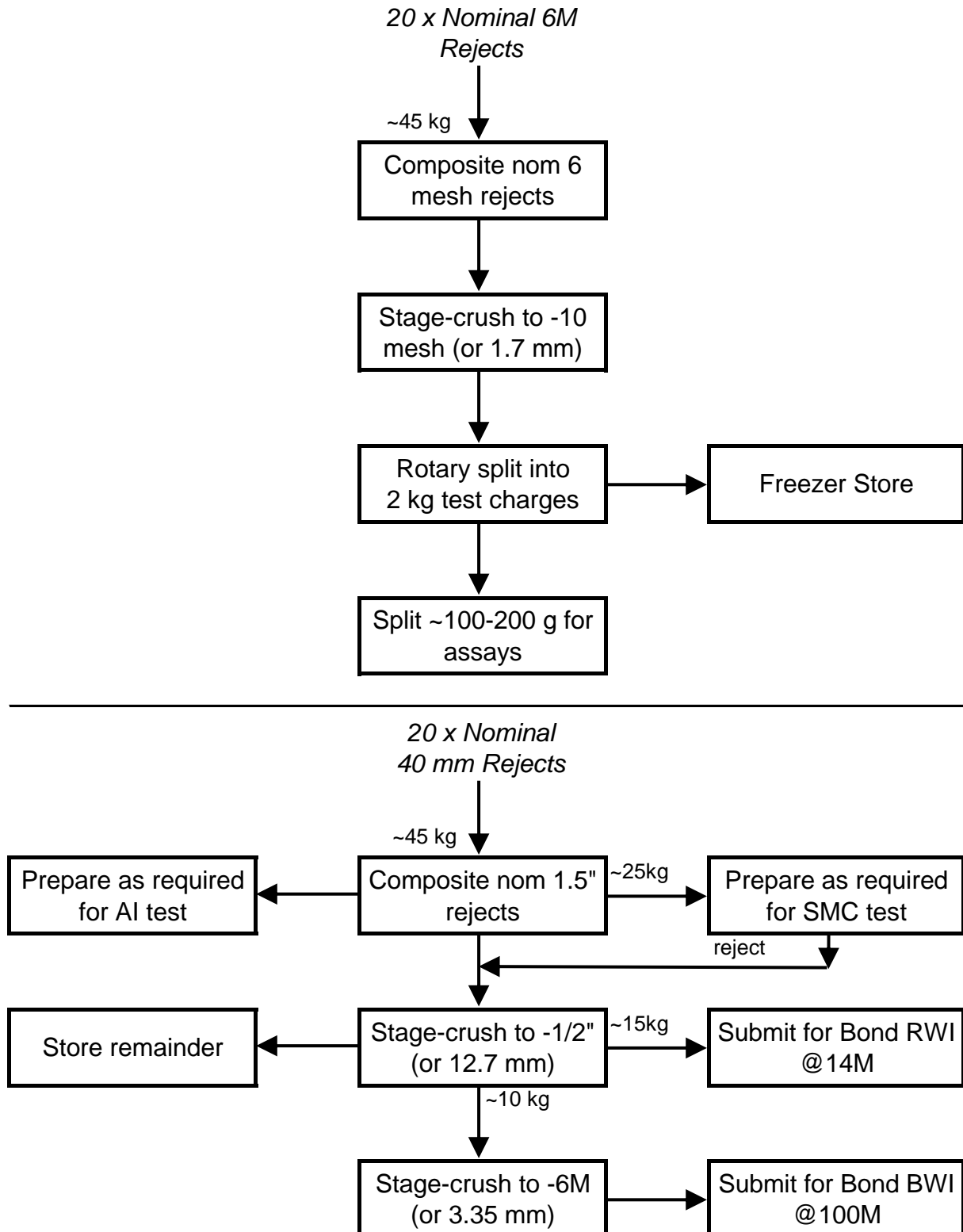

Appendix B – Head Characterization

Head Assays of Individual Core Samples

Tag	Sample ID	Cu,%	Ni, %	S %	Au g/t	Pt g/t	Pd g/t
1	HG Sample Heads D15719	0.94	0.63	8.56	0.08	0.22	0.97
2	HG Sample Heads D15720	0.68	0.82	10.7	0.11	0.33	1.23
3	HG Sample Heads D15721	0.79	0.77	9.96	0.07	0.30	0.94
4	HG Sample Heads D15730	0.42	0.58	7.91	0.06	0.22	1.08
5	HG Sample Heads D15731	0.50	0.62	8.39	0.09	0.19	1.03
6	HG Sample Heads D15733	0.84	0.83	11.4	0.15	0.37	1.34
7	HG Sample Heads D15734	0.81	0.69	9.69	0.20	0.25	1.04
8	HG Sample Heads D15735	0.52	0.74	10.1	0.08	0.28	1.17
9	HG Sample Heads D15736	1.40	0.41	6.37	0.17	0.20	0.66
10	HG Sample Heads D15737	0.60	1.29	17.6	0.07	0.62	2.92
11	HG Sample Heads D15738	0.54	1.25	16.7	0.10	0.66	2.63
12	HG Sample Heads D15739	0.50	0.65	8.92	0.07	0.34	1.24
13	HG Sample Heads D15740	0.59	0.64	8.89	0.07	0.31	1.15
14	HG Sample Heads D15741	0.52	0.50	6.94	0.15	0.16	0.60
15	HG Sample Heads D15742	0.60	0.62	8.48	0.12	0.21	1.04
16	HG Sample Heads D15751	1.17	0.58	8.70	0.11	0.23	1.02
17	HG Sample Heads D15752	0.43	1.22	16.7	0.19	0.53	2.24
18	HG Sample Heads D15764	0.41	0.73	9.47	0.06	0.52	2.04
19	HG Sample Heads D15765	0.61	1.71	22.3	0.07	0.53	1.89
20	HG Sample Heads D15768	0.67	0.33	4.65	0.11	0.15	0.55
21	LG Sample Heads D15656	0.20	0.22	2.91	0.03	0.15	0.58
22	LG Sample Heads D15657	0.22	0.19	2.52	0.03	0.11	0.43
23	LG Sample Heads D15658	0.31	0.22	2.91	0.07	0.18	0.59
24	LG Sample Heads D15659	0.25	0.25	3.03	0.05	0.13	0.59
25	LG Sample Heads D15660	0.17	0.21	2.50	0.02	0.08	0.40
26	LG Sample Heads D15663	0.18	0.26	3.21	0.04	0.11	0.40
27	LG Sample Heads D15664	0.21	0.19	2.62	0.03	0.08	0.34
28	LG Sample Heads D15665	0.33	0.24	3.16	0.30	0.10	0.38
29	LG Sample Heads D15666	0.21	0.18	2.11	0.02	0.05	0.2
30	LG Sample Heads D15667	0.30	0.30	3.71	0.04	0.09	0.46
31	LG Sample Heads D15668	0.12	0.13	1.46	< 0.02	0.04	0.16
32	LG Sample Heads D15669	0.27	0.40	4.73	0.04	0.10	0.46
33	LG Sample Heads D15670	0.33	0.55	6.44	< 0.02	< 0.02	0.03
34	LG Sample Heads D15678	0.33	0.38	4.54	0.06	0.19	0.88
35	LG Sample Heads D15687	0.38	0.39	4.75	0.08	0.20	0.63
36	LG Sample Heads D15688	0.44	0.59	6.85	0.07	0.28	1.08
37	LG Sample Heads D15689	0.52	0.46	5.48	0.09	0.20	0.86
38	LG Sample Heads D15690	0.77	0.72	8.78	0.17	0.34	1.53
39	LG Sample Heads D15694	1.10	0.49	6.35	0.13	0.31	1.04
40	LG Sample Heads D15695	1.91	0.41	6.48	0.22	0.47	1.54
41	LG Sample Heads D15700	0.55	0.64	7.88	0.10	0.26	1.25
42	LG Sample Heads D15702	0.51	0.46	6.04	0.10	0.19	0.89
43	LG Sample Heads D15703	0.69	0.37	5.04	0.14	0.16	0.70
44	LG Sample Heads D15707	0.37	0.87	10.8	0.16	0.47	1.40
45	LG Sample Heads D15708	0.44	0.32	4.16	0.09	0.23	0.66
46	LG Sample Heads D15711	1.03	0.67	9.55	0.13	0.40	1.71
47	LG Sample Heads D15713	0.63	0.42	5.96	0.09	0.18	0.91
48	LG Sample Heads D15714	0.87	0.42	6.30	1.32	0.18	0.82
49	LG Sample Heads D15715	0.68	0.46	6.65	0.14	0.26	0.87
50	LG Sample Heads D15716	0.46	0.55	7.74	0.08	0.21	1.02
51	LG Sample Heads D15717	0.63	0.53	7.24	0.09	0.24	0.97
52	LG Sample Heads D15718	1.11	0.38	5.67	0.15	0.17	0.74
53	LG Sample Heads D15722	0.44	0.37	4.88	0.08	0.14	0.68
54	LG Sample Heads D15723	0.58	0.34	4.46	0.66	0.15	0.62
55	LG Sample Heads D15724	0.51	0.63	7.52	0.07	0.29	0.99
56	LG Sample Heads D15725	0.92	0.39	5.24	0.11	0.17	0.71



QEMSCAN DATA

prepared for:

North American Nickel

Project 18559-01

MI5022-AUG21

August 30, 2021

Prepared by:



Margot Aldis/Chris Gunning
Mineralogist/Senior Mineralogist

High Definition Mineralogical Analysis using QEMSCAN (Quantitative Evaluation of Materials by Scanning Electron Microscopy) (METH# 8.11.1) used by SGS Minerals Services

SGS Canada

P.O. Box 4300, 185 Concession Street, Lakefield, Ontario, Canada K0L 2H0
Tel. (705) 652-6365 www.sgs.com www.sgs.com/met
Member of the SGS Group (SGS SA)

North American Nickel
 18559-01
 MI5022-AUG21

High Definition Mineralogical Analysis using QEMSCAN (Quantitative Evaluation of Materials by Scanning Electron Microscopy)

Assay Reconciliation

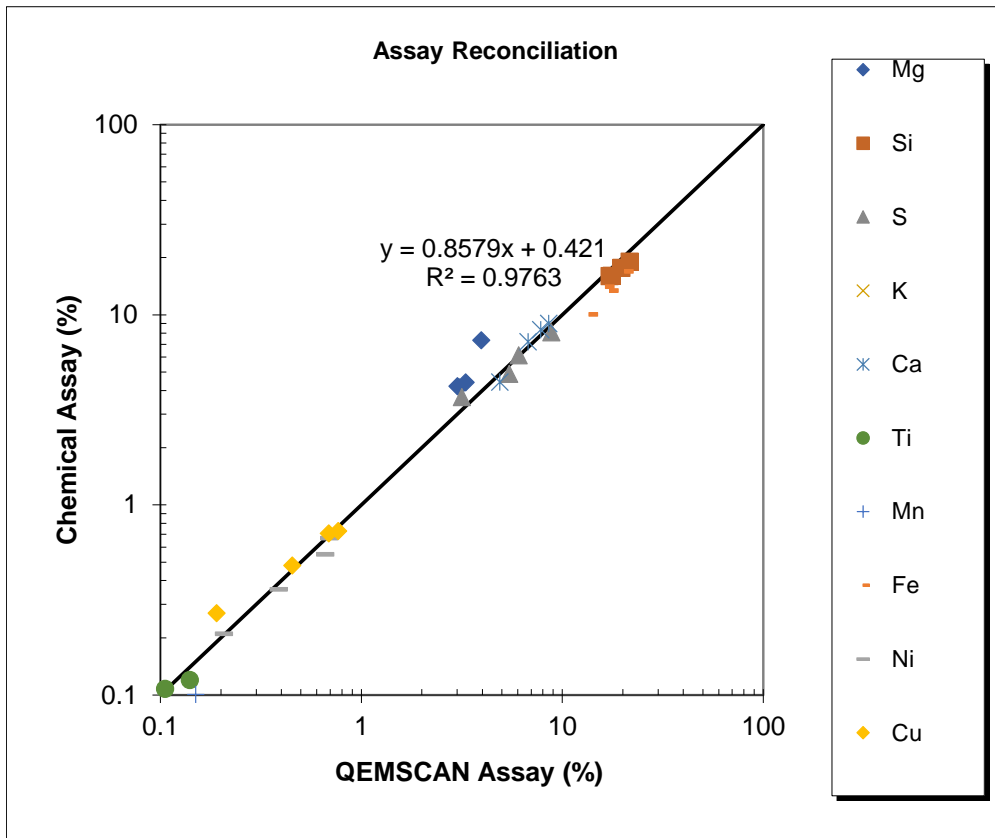

Sample	LG Comp 30 min				
	Combined	+106um	-106/+53um	-53/+20um	-20um
Mg (QEMSCAN)	3.38	3.30	3.00	3.06	3.95
Mg (Chemical)	5.20	4.41	4.22	4.15	7.36
Si (QEMSCAN)	19.13	21.65	19.67	17.62	17.18
Si (Chemical)	17.27	19.02	17.67	16.03	15.99
S (QEMSCAN)	5.53	3.16	6.06	8.81	5.45
S (Chemical)	5.40	3.70	6.12	8.09	4.89
K (QEMSCAN)	0.07	0.09	0.07	0.07	0.06
K (Chemical)	0.07	0.09	0.06	0.04	0.07
Ca (QEMSCAN)	6.96	8.55	7.82	6.74	4.89
Ca (Chemical)	7.17	9.01	8.36	7.22	4.43
Ti (QEMSCAN)	0.11	0.14	0.11	0.07	0.09
Ti (Chemical)	0.11	0.12	0.11	0.09	0.10
Mn (QEMSCAN)	0.12	0.11	0.10	0.09	0.15
Mn (Chemical)	0.09	0.09	0.09	0.08	0.10
Fe (QEMSCAN)	16.48	13.56	17.22	20.41	16.40
Fe (Chemical)	13.27	10.07	13.43	16.93	14.06
Ni (QEMSCAN)	0.47	0.21	0.39	0.69	0.66
Ni (Chemical)	0.43	0.21	0.36	0.67	0.55
Cu (QEMSCAN)	0.50	0.19	0.45	0.77	0.69
Cu (Chemical)	0.53	0.27	0.48	0.73	0.71

North American Nickel
18559-01
MI5022-AUG21

High Definition Mineralogical Analysis using QEMSCAN (Quantitative
Evaluation of Materials by Scanning Electron Microscopy)

Modals

Survey		18559-01 / MI5022-AUG21									
Project		North American Nickel									
Sample		LG Comp 30 min									
Fraction		Combined	+106um			-106/+53um		-53/+20um		-20um	
Mass Size Distribution (%)			28.9			23.3		17.8		30.0	
Calculated ESD Particle Size		17	96			49		23		7	
		Sample	Sample	Fraction	Sample	Fraction	Sample	Fraction	Sample	Fraction	
Mineral Mass (%)	Pyrrhotite	11.22	1.85	6.41	2.95	12.69	3.29	18.43	3.13	10.44	
	Chalcopyrite	1.44	0.15	0.52	0.30	1.28	0.39	2.21	0.60	1.99	
	Pentlandite	1.20	0.15	0.51	0.22	0.94	0.31	1.75	0.52	1.74	
	Pyrite/Marcasite	0.10	0.02	0.08	0.03	0.15	0.02	0.09	0.02	0.08	
	Other_Sulphides	0.03	0.01	0.03	0.01	0.03	0.00	0.03	0.01	0.04	
	Fe-Oxides	0.29	0.03	0.11	0.02	0.09	0.05	0.28	0.19	0.62	
	Other_Oxides	0.02	0.01	0.05	0.00	0.01	0.00	0.00	0.00	0.01	
	Chlorite/Clays	26.17	5.58	19.30	4.32	18.55	3.64	20.43	12.62	42.12	
	Biotite	0.09	0.04	0.13	0.02	0.10	0.01	0.07	0.01	0.04	
	Talc	0.28	0.05	0.16	0.04	0.15	0.04	0.22	0.16	0.52	
	Quartz	4.09	1.02	3.53	0.94	4.02	0.65	3.64	1.48	4.94	
	Plagioclase	17.68	7.14	24.69	4.74	20.34	2.73	15.34	3.07	10.23	
	Amphibole/Pyroxene	18.45	6.35	21.94	4.48	19.25	3.36	18.83	4.27	14.23	
	K-Feldspar	0.09	0.02	0.08	0.02	0.08	0.01	0.08	0.04	0.13	
	Epidote	17.28	6.04	20.88	4.78	20.51	3.02	16.94	3.44	11.49	
	Titanite/sphene	0.44	0.14	0.50	0.11	0.46	0.05	0.30	0.13	0.44	
	Other Silicates	0.45	0.20	0.70	0.15	0.63	0.07	0.41	0.03	0.09	
	Carbonates	0.55	0.06	0.21	0.14	0.60	0.15	0.85	0.19	0.65	
	Apatite	0.02	0.00	0.01	0.00	0.01	0.00	0.02	0.02	0.05	
	Other	0.13	0.04	0.15	0.02	0.10	0.02	0.09	0.05	0.16	
	Total	100.00	28.92	100.0	23.28	100.0	17.83	100.0	29.97	100.0	
Mean Grain Size by Frequency (µm)	Pyrrhotite	17		38		36		20		8	
	Chalcopyrite	12		26		30		22		7	
	Pentlandite	10		16		16		14		7	
	Pyrite/Marcasite	13		14		18		12		9	
	Other_Sulphides	6		9		7		8		4	
	Fe-Oxides	8		16		13		12		6	
	Other_Oxides	12		18		10		6		4	
	Chlorite/Clays	9		22		18		13		6	
	Biotite	8		10		9		7		5	
	Talc	5		9		7		4		4	
	Quartz	10		25		21		14		5	
	Plagioclase	13		24		18		11		6	
	Amphibole/Pyroxene	14		28		22		16		6	
	K-Feldspar	6		9		8		7		5	
	Epidote	11		17		15		10		6	
	Titanite/sphene	10		16		14		10		6	
	Other Silicates	7		9		8		5		4	
	Carbonates	12		16		29		20		7	
	Apatite	7		17		9		11		6	
	Other	5		10		7		5		4	

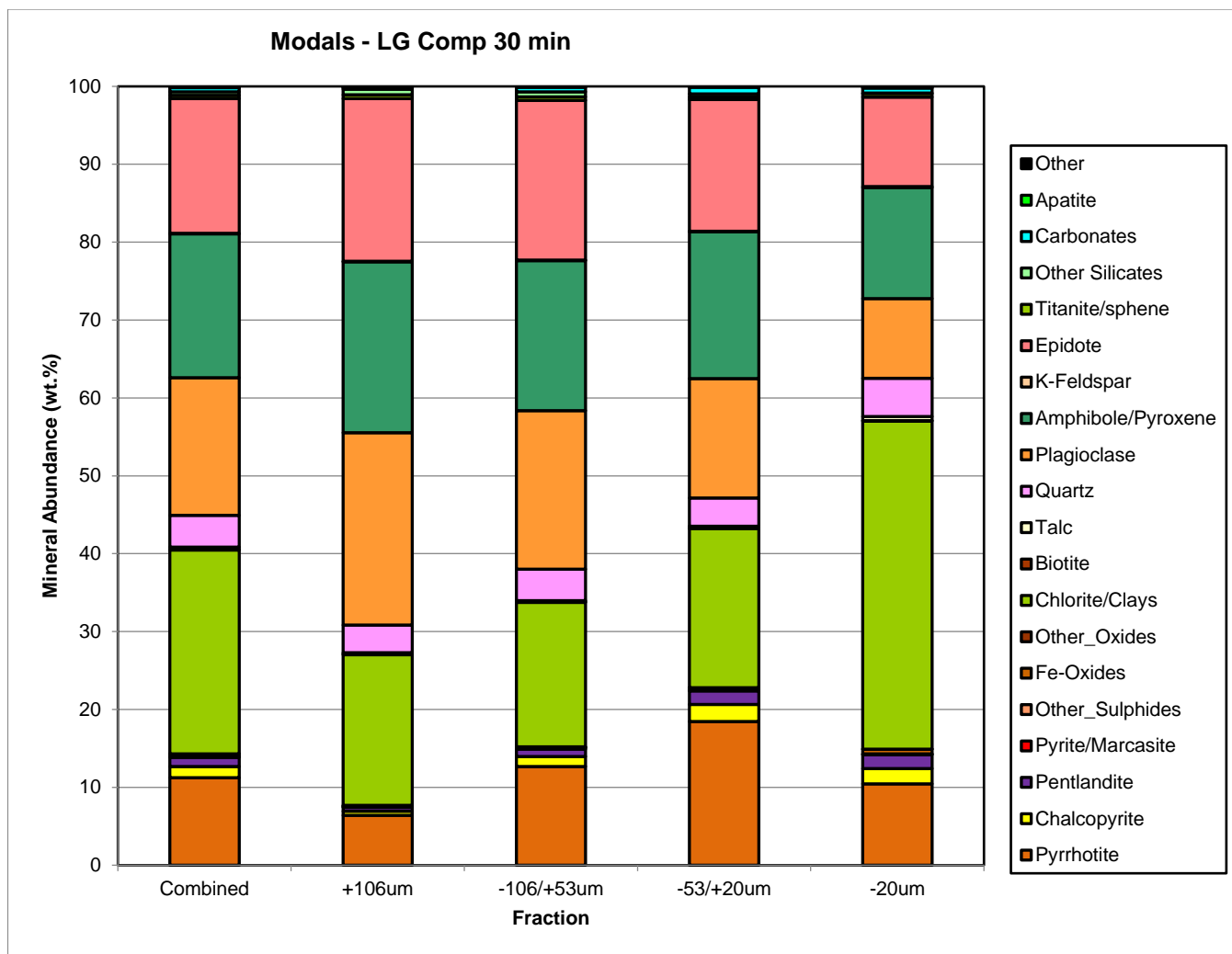

North American Nickel
 18559-01
 MI5022-AUG21

High Definition Mineralogical Analysis using QEMSCAN (Quantitative Evaluation of Materials by Scanning Electron Microscopy)

Cu Department

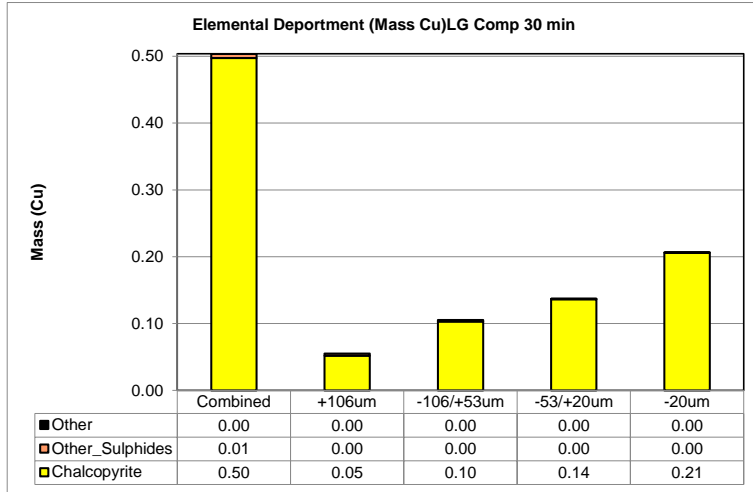

Elemental Department (Mass Cu) LG Comp 30 min

Mineral Name	Combined	+106um	-106/+53um	-53/+20um	-20um
Chalcopyrite	0.50	0.05	0.10	0.14	0.21
Other_Sulphides	0.01	0.00	0.00	0.00	0.00
Other	0.00	0.00	0.00	0.00	0.00
Total	0.50	0.06	0.11	0.14	0.21
Total (% in fraction)	100.00	10.94	20.94	27.16	40.96

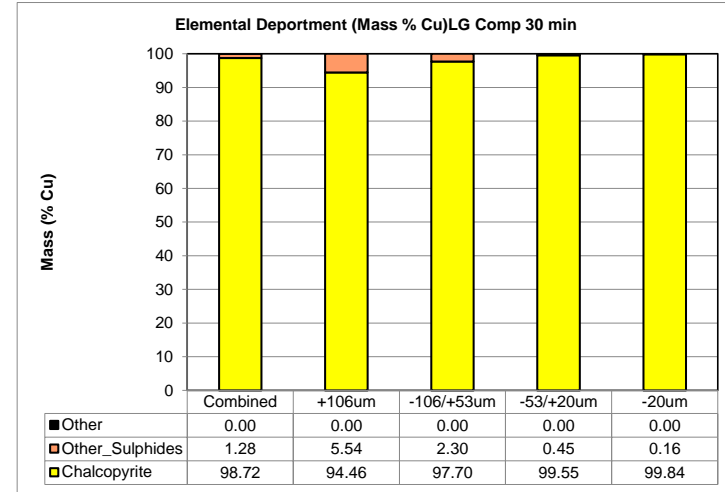

Elemental Department (Mass % Cu) LG Comp 30 min

Mineral Name	Combined	+106um	-106/+53um	-53/+20um	-20um
Chalcopyrite	98.72	94.46	97.70	99.55	99.84
Other_Sulphides	1.28	5.54	2.30	0.45	0.16
Other	0.00	0.00	0.00	0.00	0.00
Total	100.00	100.00	100.00	100.00	100.00

North American Nickel
 18559-01
 MI5022-AUG21

High Definition Mineralogical Analysis using QEMSCAN (Quantitative Evaluation of Materials by Scanning Electron Microscopy)

Ni Department

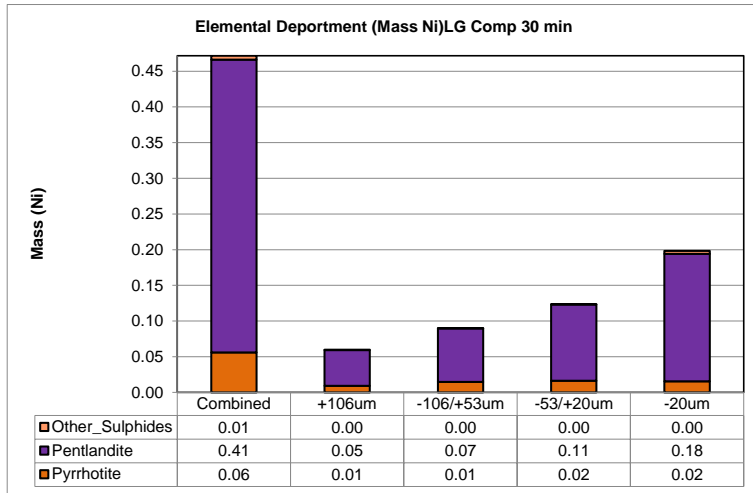

Elemental Department (Mass Ni) LG Comp 30 min

Mineral Name	Combined	+106um	-106/+53um	-53/+20um	-20um
Pyrrhotite	0.06	0.01	0.01	0.02	0.02
Pentlandite	0.41	0.05	0.07	0.11	0.18
Other_Sulphides	0.01	0.00	0.00	0.00	0.00
Total	0.47	0.06	0.09	0.12	0.20
Total (% in fraction)	100.00	12.68	19.11	26.20	42.01

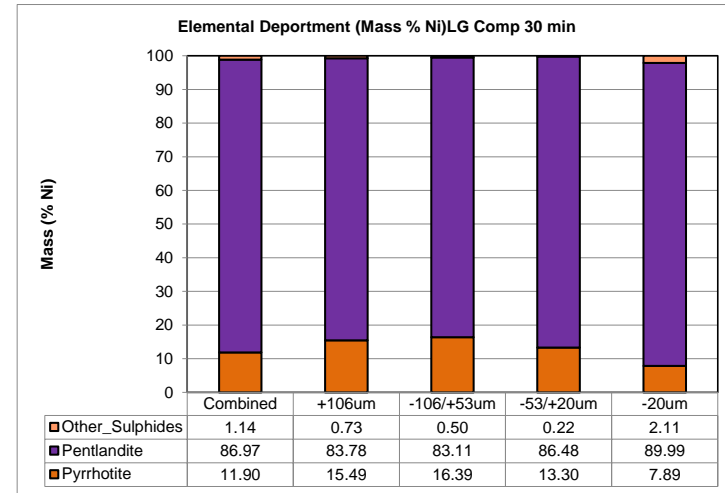

Elemental Department (Mass % Ni) LG Comp 30 min

Mineral Name	Combined	+106um	-106/+53um	-53/+20um	-20um
Pyrrhotite	11.90	15.49	16.39	13.30	7.89
Pentlandite	86.97	83.78	83.11	86.48	89.99
Other_Sulphides	1.14	0.73	0.50	0.22	2.11
Total	100.00	100.00	100.00	100.00	100.00

North American Nickel
18559-01
MI5022-AUG21

High Definition Mineralogical Analysis using QEMSCAN (Quantitative Evaluation of Materials by Scanning Electron Microscopy)

Pentlandite Liberation

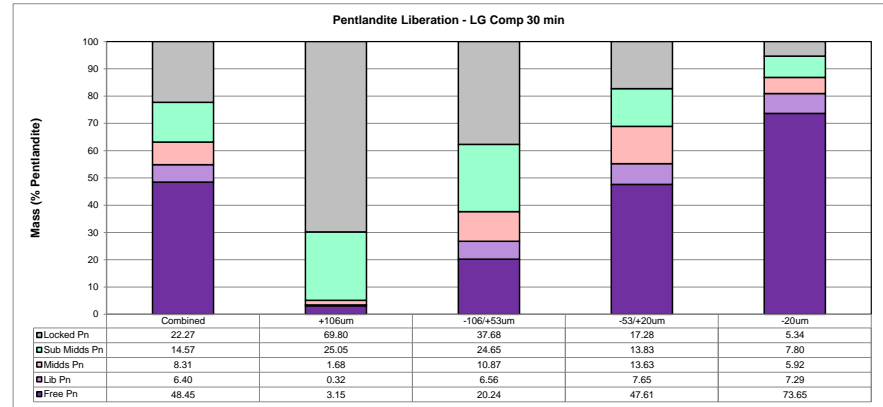
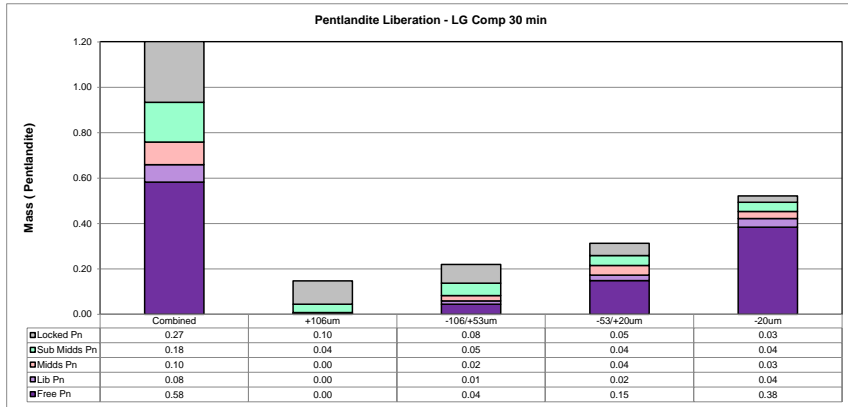

Absolute Mass of Pentlandite Across Fraction LG Comp 30 min

Mineral Name	Combined	+106um	-106/+53um	-53/+20um	-20um
Free Pn	0.58	0.00	0.04	0.15	0.38
Lib Pn	0.08	0.00	0.01	0.02	0.04
Mids Pn	0.10	0.00	0.02	0.04	0.03
Sub Mids Pn	0.18	0.04	0.05	0.04	0.04
Locked Pn	0.27	0.10	0.08	0.05	0.03
Total	1.20	0.15	0.22	0.31	0.52
Total (% in fraction)	100.0	12.3	18.3	26.0	43.4

Normalized Mass of Pentlandite Across Fraction LG Comp 30 min

Mineral Name	Combined	+106um	-106/+53um	-53/+20um	-20um
Free Pn	48.45	3.15	20.24	47.61	73.65
Lib Pn	6.40	0.32	6.56	7.65	7.29
Mids Pn	8.31	1.68	10.87	13.63	5.92
Sub Mids Pn	14.57	25.05	24.65	13.83	7.80
Locked Pn	22.27	69.80	37.68	17.28	5.34
Total	100.0	100.0	100.0	100.0	100.0

North American Nickel
18559-01
MI5022-AUG21

High Definition Mineralogical Analysis using QEMSCAN (Quantitative Evaluation of Materials by Scanning Electron Microscopy)

Pentlandite Association

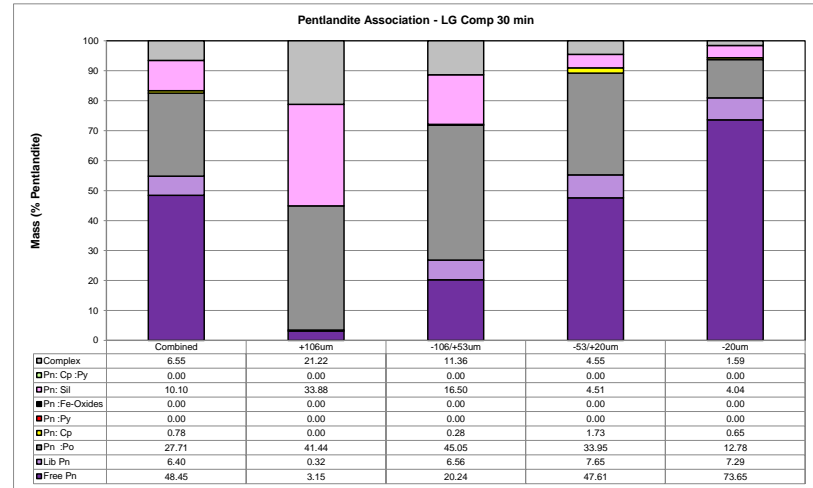
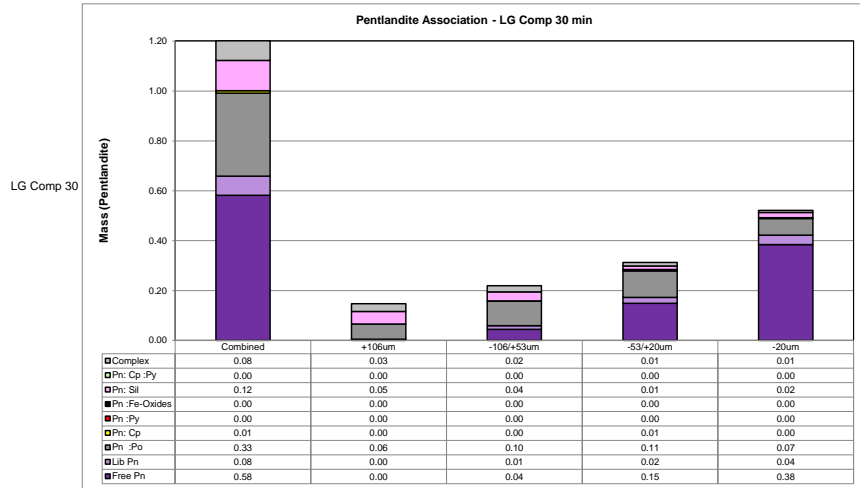

Absolute Mass of Pentlandite Across Fraction LG Comp 30 min

Mineral Name	Combined	+106um	-106/+53um	-53/+20um	-20um
Free Pn	0.58	0.00	0.04	0.15	0.38
Lib Pn	0.08	0.00	0.01	0.02	0.04
Pn:Po	0.33	0.06	0.10	0.11	0.07
Pn:Cp	0.01	0.00	0.00	0.01	0.00
Pn:Py	0.00	0.00	0.00	0.00	0.00
Pn:Fe-Oxides	0.00	0.00	0.00	0.00	0.00
Pn:Si	0.12	0.05	0.04	0.01	0.02
Pn:Cp:Py	0.00	0.00	0.00	0.00	0.00
Complex	0.08	0.03	0.02	0.01	0.01
Total	1.20	0.15	0.22	0.31	0.52
Total (% in fraction)	100.0	12.3	18.3	26.0	43.4

Normalized Mass of Pentlandite Across Fraction LG Comp 30 min

Mineral Name	Combined	+106um	-106/+53um	-53/+20um	-20um
Free Pn	48.45	3.15	20.24	47.61	73.65
Lib Pn	6.40	0.32	6.56	7.65	7.29
Pn:Po	27.71	41.44	45.05	33.95	12.78
Pn:Cp	0.78	0.00	0.28	1.73	0.65
Pn:Py	0.00	0.00	0.00	0.00	0.00
Pn:Fe-Oxides	0.00	0.00	0.00	0.00	0.00
Pn:Si	10.10	33.88	16.50	4.51	4.04
Pn:Cp:Py	0.00	0.00	0.00	0.00	0.00
Complex	6.55	21.22	11.36	4.55	1.59
Total	100.0	100.0	100.0	100.0	100.0
Liberated	54,84977999	3,466386555	26,80349522	55,26170364	80,93862816

North American Nickel
18559-01
MI5022-AUG21

High Definition Mineralogical Analysis using

Image Grid - Pentlandite Association

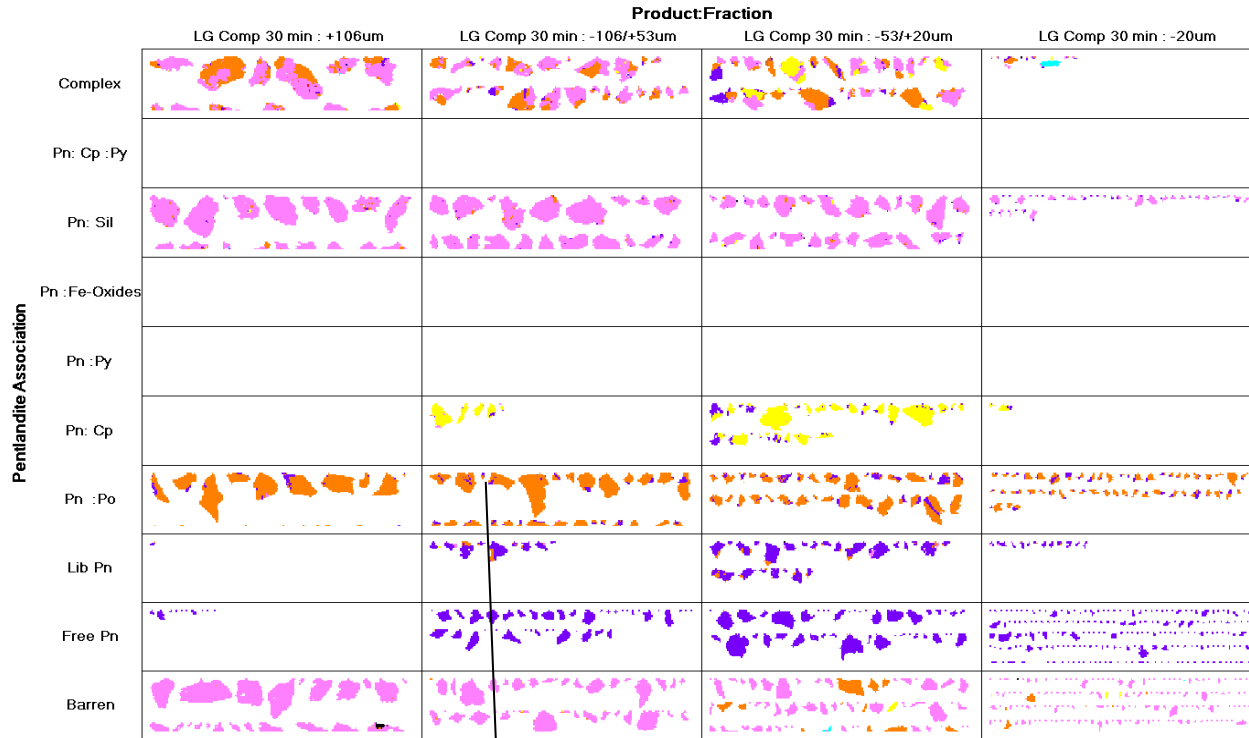

North American Nickel
18559-01
MI5022-AUG21

High Definition Mineralogical Analysis using QEMSCAN (Quantitative Evaluation of Materials by Scanning Electron Microscopy)

Pyrrhotite Liberation

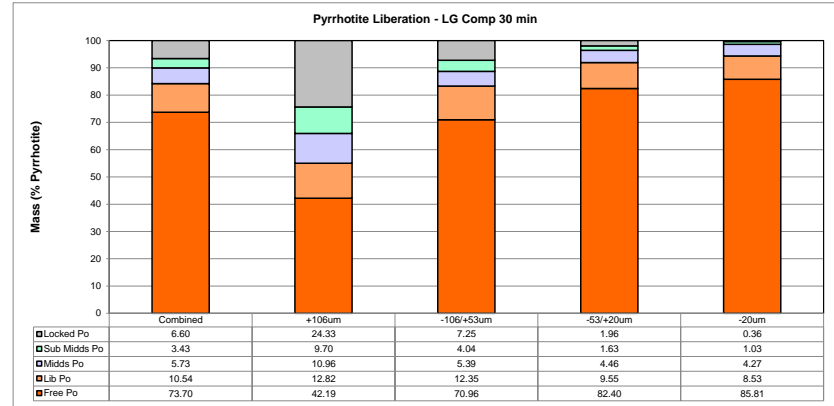
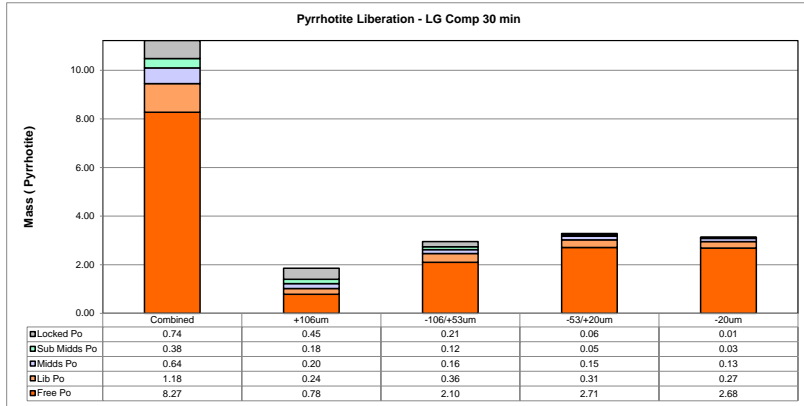

Absolute Mass of Pyrrhotite Across Fraction LG Comp 30 min

Mineral Name	Combined	+106um	-106/+53um	-53/+20um	-20um
Free Po	8.27	0.78	2.10	2.71	2.68
Lib Po	1.18	0.24	0.36	0.31	0.27
Mids Po	0.64	0.20	0.16	0.15	0.13
Sub Mids Po	0.38	0.18	0.12	0.05	0.03
Locked Po	0.74	0.45	0.21	0.06	0.01
Total	11.22	1.85	2.95	3.29	3.13
Total (% in fraction)	100.0	16.5	26.3	29.3	27.9

Normalized Mass of Pyrrhotite Across Fraction LG Comp 30 min

Mineral Name	Combined	+106um	-106/+53um	-53/+20um	-20um
Free Po	73.70	42.19	70.96	82.40	85.81
Lib Po	10.54	12.82	12.35	9.55	8.53
Mids Po	5.73	10.96	5.39	4.46	4.27
Sub Mids Po	3.43	9.70	4.04	1.63	1.03
Locked Po	6.60	24.33	7.25	1.96	0.36
Total	100.0	100.0	100.0	100.0	100.0

North American Nickel
18559-01
MI5022-AUG21

High Definition Mineralogical Analysis using QEMSCAN (Quantitative Evaluation of Materials by Scanning Electron Microscopy)

Pyrrhotite Association

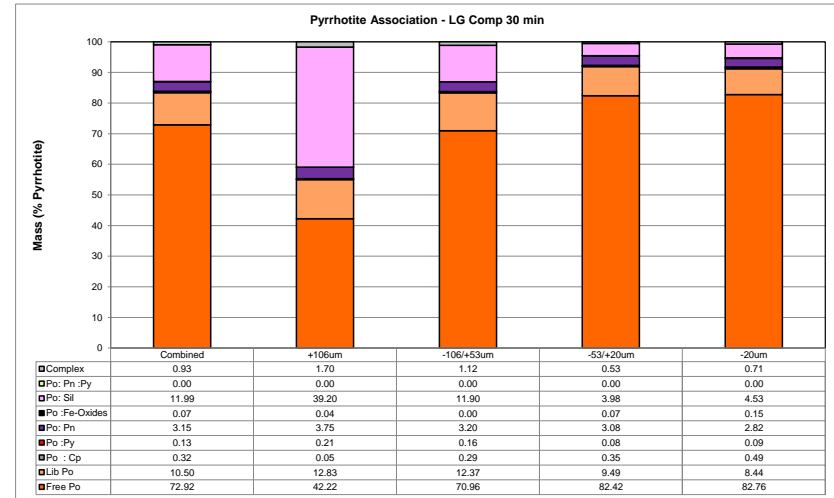
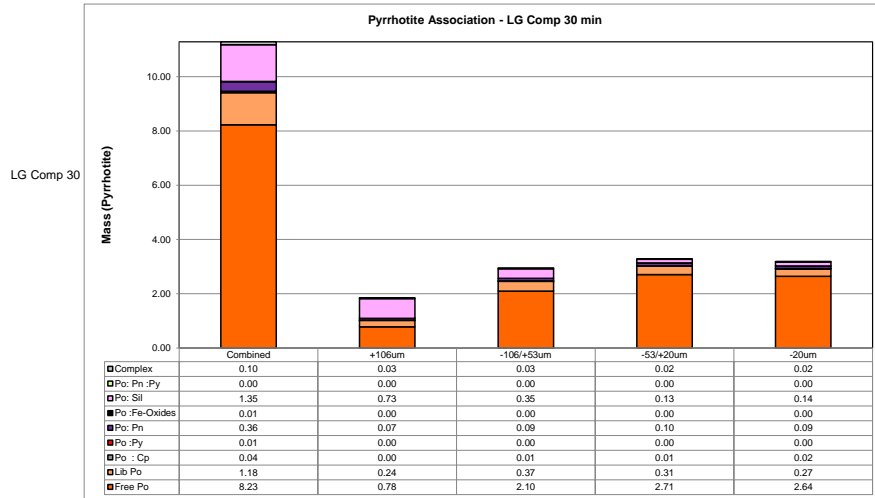

Absolute Mass of Pyrrhotite Across Fraction LG Comp 30 min

Mineral Name	Combined	+106um	-106/+53um	-53/+20um	-20um
Free Po	8.23	0.78	2.10	2.71	2.64
Lib Po	1.18	0.24	0.37	0.31	0.27
Po : Cp	0.04	0.00	0.01	0.01	0.02
Po :Py	0.01	0.00	0.00	0.00	0.00
Po : Pn	0.36	0.07	0.09	0.10	0.09
Po :Fe-Oxides	0.01	0.00	0.00	0.00	0.00
Po : Sil	1.35	0.73	0.35	0.13	0.14
Po : Pn :Py	0.00	0.00	0.00	0.00	0.00
Complex	0.10	0.03	0.03	0.02	0.02
Total	11.28	1.85	2.95	3.29	3.19
Total (% in fraction)	100.0	16.4	26.2	29.1	28.3

Normalized Mass of Pyrrhotite Across Fraction LG Comp 30 min

Mineral Name	Combined	+106um	-106/+53um	-53/+20um	-20um
Free Po	72.92	42.22	70.96	82.42	82.76
Lib Po	10.50	12.83	12.37	9.49	8.44
Po : Cp	0.32	0.05	0.29	0.35	0.49
Po :Py	0.13	0.21	0.16	0.08	0.09
Po : Pn	3.15	3.75	3.20	3.08	2.82
Po :Fe-Oxides	0.07	0.04	0.00	0.07	0.15
Po : Sil	11.99	39.20	11.90	3.98	4.53
Po : Pn :Py	0.00	0.00	0.00	0.00	0.00
Complex	0.93	1.70	1.12	0.53	0.71
Total	100.0	100.0	100.0	100.0	100.0
Liberated	83.41504556	55.05026136	83.33284871	91.9092308	91.20142921

North American Nickel
18559-01
MI5022-AUG21

High Definition Mineralogical Analysis using

Image Grid - Pyrrhotite Association



- Background
- Pyrrhotite
- Chalcopyrite
- Pentlandite
- Other-Cu-Sulphides
- Pyrite
- Other_Sulphides
- Fe-Oxides
- Carbonates
- Silicates
- Other

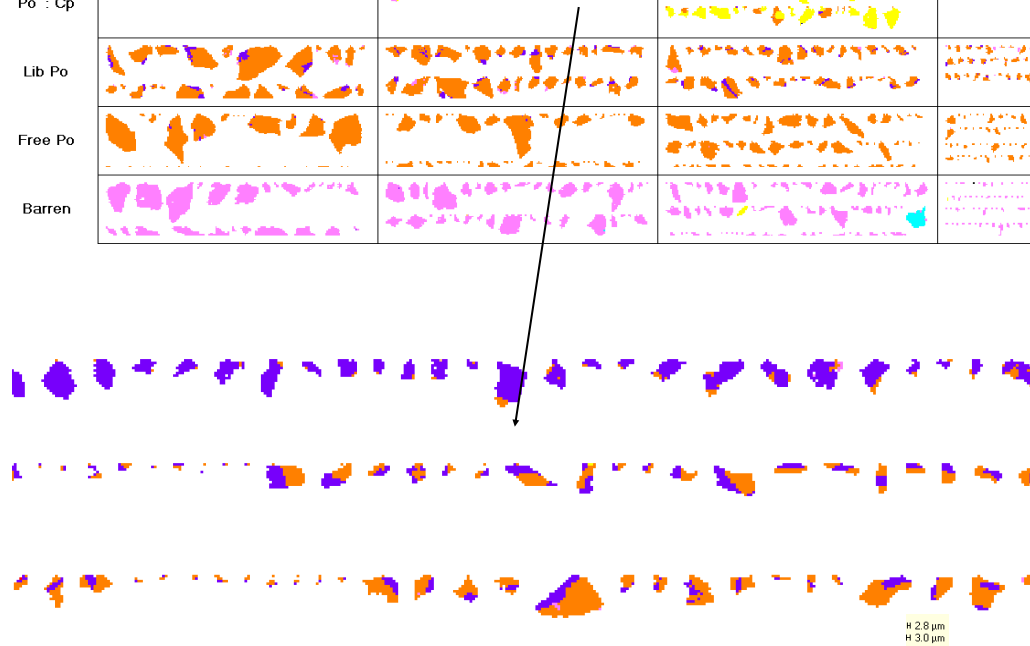

North American Nickel
18559-01
MI5022-AUG21

High Definition Mineralogical Analysis using QEMSCAN (Quantitative Evaluation of Materials by Scanning Electron Microscopy)

Chalcopyrite Liberation

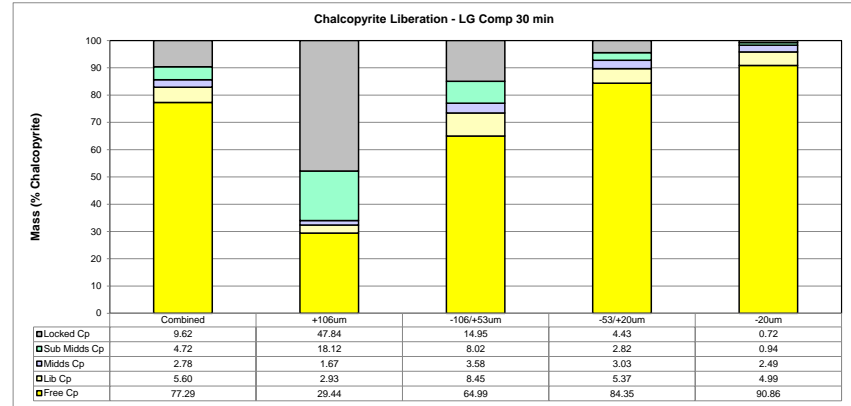
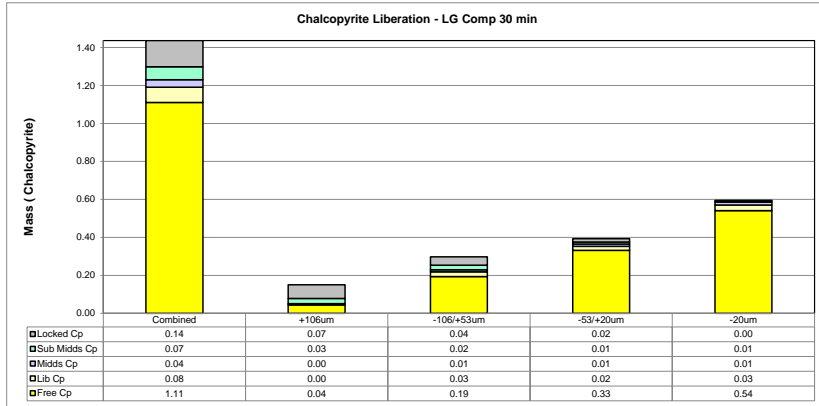

Absolute Mass of Chalcopyrite Across Fraction LG Comp 30 min

Mineral Name	Combined	+106um	-106/+53um	-53/+20um	-20um
Free Cp	1.11	0.04	0.19	0.33	0.54
Lib Cp	0.08	0.00	0.03	0.02	0.03
Mids Cp	0.04	0.00	0.01	0.01	0.01
Sub Mids Cp	0.07	0.03	0.02	0.01	0.01
Locked Cp	0.14	0.07	0.04	0.02	0.00
Total	1.44	0.15	0.30	0.39	0.60
Total (% in fraction)	100.0	10.5	20.7	27.4	41.4

Normalized Mass of Chalcopyrite Across Fraction LG Comp 30 min

Mineral Name	Combined	+106um	-106/+53um	-53/+20um	-20um
Free Cp	77.29	29.44	64.99	84.35	90.86
Lib Cp	5.60	2.93	8.45	5.37	4.99
Mids Cp	2.78	1.67	3.58	3.03	2.49
Sub Mids Cp	4.72	18.12	8.02	2.82	0.94
Locked Cp	9.62	47.84	14.95	4.43	0.72
Total	100.0	100.0	100.0	100.0	100.0

North American Nickel
18559-01
MI5022-AUG21

High Definition Mineralogical Analysis using QEMSCAN (Quantitative Evaluation of Materials by Scanning Electron Microscopy)

Chalcopyrite Association

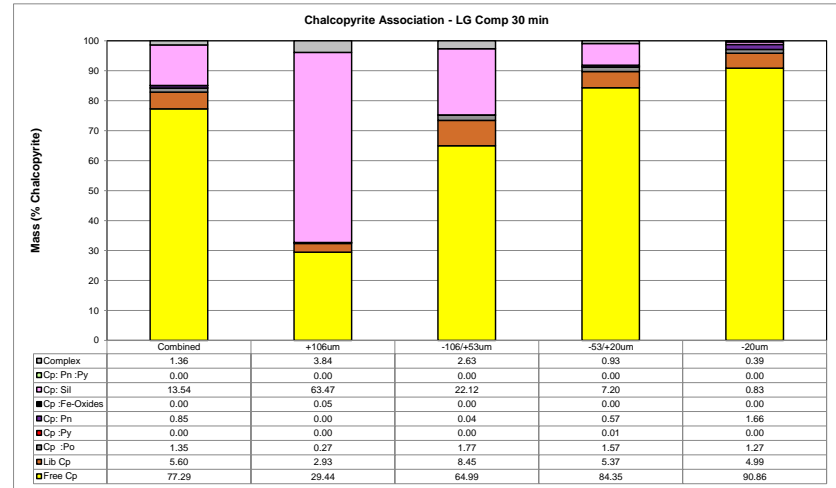
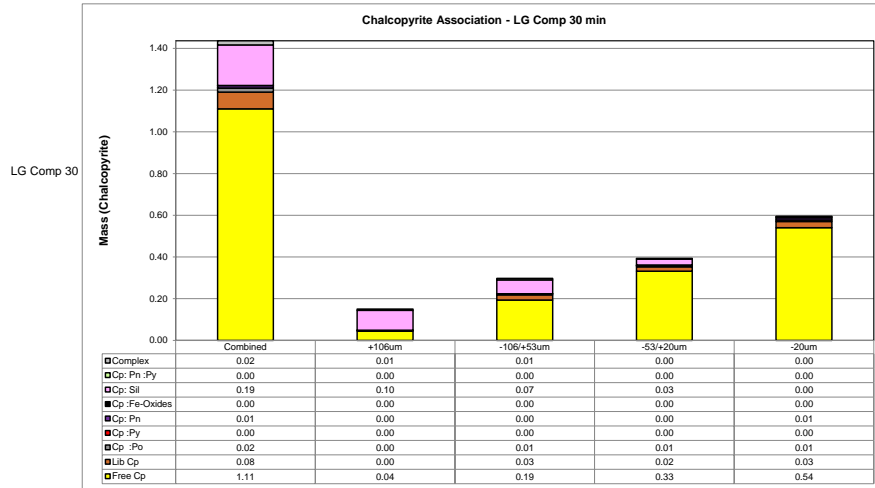

Absolute Mass of Chalcopyrite Across Fraction LG Comp 30 min

Mineral Name	Combined	+106um	-106/+53um	-53/+20um	-20um
Free Cp	1.11	0.04	0.19	0.33	0.54
Lib Cp	0.08	0.00	0.03	0.02	0.03
Cp :Po	0.02	0.00	0.01	0.01	0.01
Cp :Py	0.00	0.00	0.00	0.00	0.00
Cp :Pn	0.01	0.00	0.00	0.00	0.01
Cp :Fe-Oxides	0.00	0.00	0.00	0.00	0.00
Cp :Sil	0.19	0.10	0.07	0.03	0.00
Cp :Pn :Py	0.00	0.00	0.00	0.00	0.00
Complex	0.02	0.01	0.01	0.00	0.00
Total	1.44	0.15	0.30	0.39	0.60
Total (% in fraction)	100.0	10.5	20.7	27.4	41.4

Normalized Mass of Chalcopyrite Across Fraction LG Comp 30 min

Mineral Name	Combined	+106um	-106/+53um	-53/+20um	-20um
Free Cp	77.29	29.44	64.99	84.35	90.86
Lib Cp	5.60	2.93	8.45	5.37	4.99
Cp :Po	1.35	0.27	1.77	1.57	1.27
Cp :Py	0.00	0.00	0.00	0.01	0.00
Cp :Pn	0.85	0.00	0.04	0.57	1.66
Cp :Fe-Oxides	0.00	0.05	0.00	0.00	0.00
Cp :Sil	13.54	63.47	22.12	7.20	0.83
Cp :Pn :Py	0.00	0.00	0.00	0.00	0.00
Complex	1.36	3.84	2.63	0.93	0.39
Total	100.0	100.0	100.0	100.0	100.0
Liberated	77.28678071	29.4371458	64.99081124	84.35054057	90.85872576

North American Nickel
18559-01
MI5022-AUG21

High Definition Mineralogical Analysis using

Image Grid - Chalcopyrite Association



North American Nickel
 18559-01
 MI5022-AUG21

High Definition Mineralogical Analysis using QEMSCAN (Quantitative Evaluation of Materials by Scanning Electron Microscopy)

Silicates Liberation

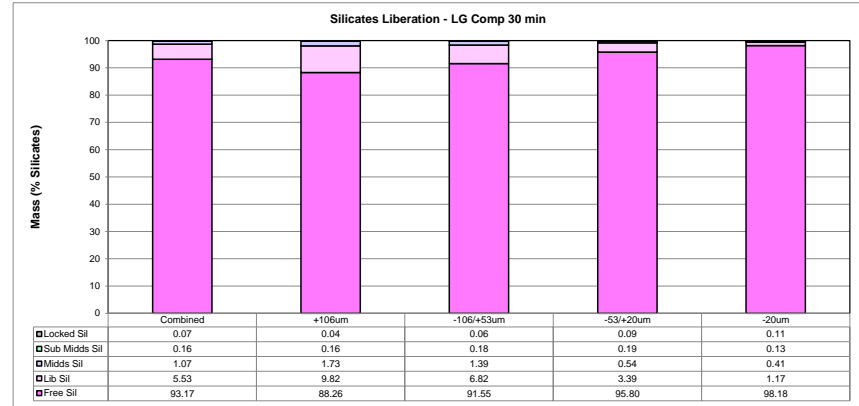
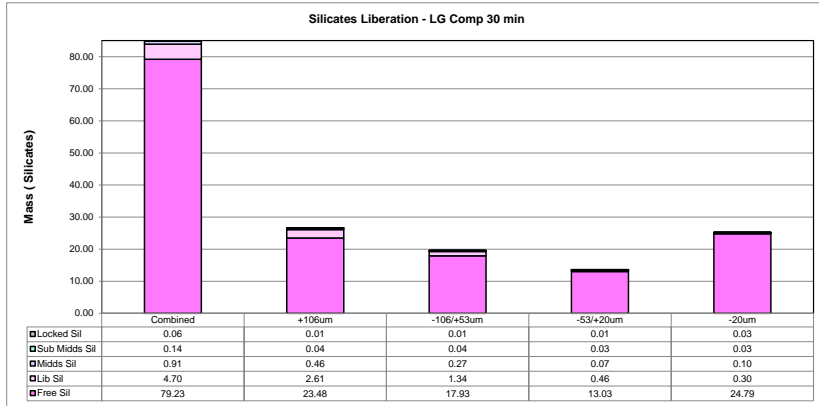

Absolute Mass of Silicates Across Fraction LG Comp 30 min

Mineral Name	Combined	+106um	-106/+53um	-53/+20um	-20um
Free Sil	79.23	23.48	17.93	13.03	24.79
Lib Sil	4.70	2.61	1.34	0.46	0.30
Mids Sil	0.91	0.46	0.27	0.07	0.10
Sub Mids Sil	0.14	0.04	0.04	0.03	0.03
Locked Sil	0.06	0.01	0.01	0.01	0.03
Total	85.05	26.61	19.59	13.60	25.25
Total (% in fraction)	100.0	31.3	23.0	16.0	29.7

Normalized Mass of Silicates Across Fraction LG Comp 30 min

Mineral Name	Combined	+106um	-106/+53um	-53/+20um	-20um
Free Sil	93.17	88.26	91.55	95.80	98.18
Lib Sil	5.53	9.82	6.82	3.39	1.17
Mids Sil	1.07	1.73	1.39	0.54	0.41
Sub Mids Sil	0.16	0.16	0.18	0.19	0.13
Locked Sil	0.07	0.04	0.06	0.09	0.11
Total	100.0	100.0	100.0	100.0	100.0

North American Nickel
18559-01
MI5022-AUG21

High Definition Mineralogical Analysis using QEMSCAN (Quantitative Evaluation of Materials by Scanning Electron Microscopy)

Silicates Association

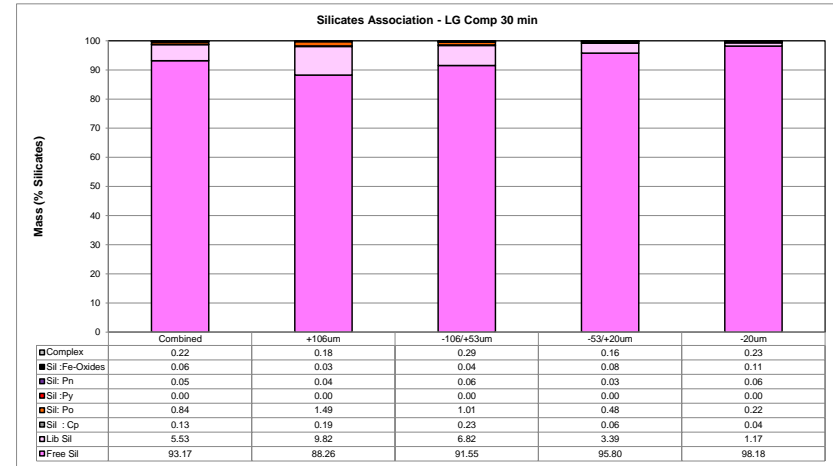
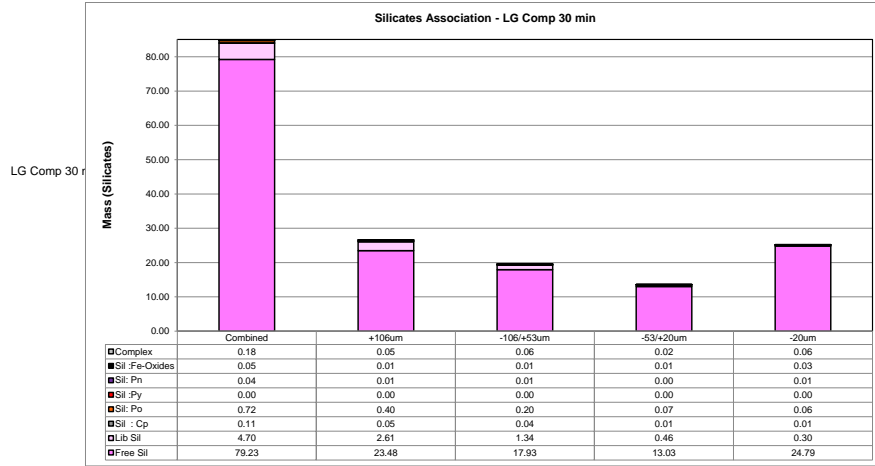

Absolute Mass of Silicates Across Fraction LG Comp 30 min

Mineral Name	Combined	+106um	-106/+53um	-53/+20um	-20um
Free Sil	79.23	23.48	17.93	13.03	24.79
Lib Sil	4.70	2.61	1.34	0.46	0.30
Sil : Cp	0.11	0.05	0.04	0.01	0.01
Sil: Po	0.72	0.40	0.20	0.07	0.06
Sil :Py	0.00	0.00	0.00	0.00	0.00
Sil: Ph	0.04	0.01	0.01	0.00	0.01
Sil :Fe-Oxides	0.05	0.01	0.01	0.01	0.03
Complex	0.18	0.05	0.06	0.02	0.06
Total	85.05	26.61	19.59	13.60	25.25
Total (% in fraction)	100.0	31.3	23.0	16.0	29.7

Normalized Mass of Silicates Across Fraction LG Comp 30 min

Mineral Name	Combined	+106um	-106/+53um	-53/+20um	-20um
Free Sil	93.17	88.26	91.55	95.80	98.18
Lib Sil	5.53	9.82	6.82	3.39	1.17
Sil : Cp	0.13	0.19	0.23	0.06	0.04
Sil: Po	0.84	1.49	1.01	0.48	0.22
Sil :Py	0.00	0.00	0.00	0.00	0.00
Sil: Ph	0.05	0.04	0.06	0.03	0.06
Sil :Fe-Oxides	0.06	0.03	0.04	0.08	0.11
Complex	0.22	0.18	0.29	0.16	0.23
Total	100.0	100.0	100.0	100.0	100.0
Liberated	98.69781987	98.07491092	98.37059174	99.18117261	99.34768951

North American Nickel
 18559-01
 MI5022-AUG21

High Definition Mineralogical Analysis using QEMSCAN (Quantitative Evaluation of Materials by Scanning Electron Microscopy)

Mineral Release Curves

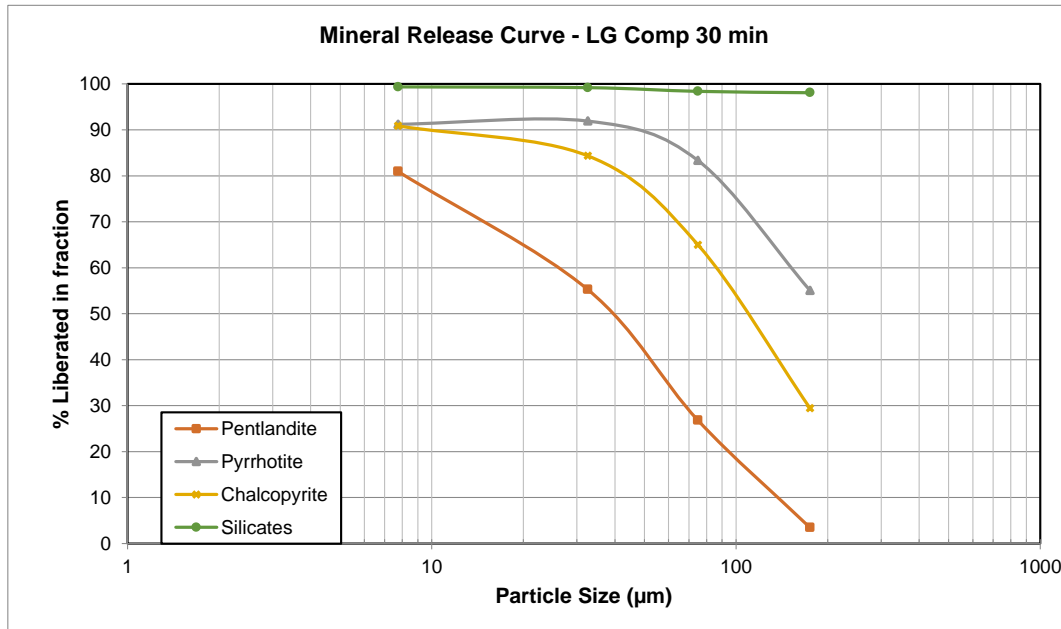

Sample	Comp 30 min			
Fraction				
Average Particle Size (µm)	175.03	74.95	32.56	7.75
Mineral Mass % 80% Lib				
Pentlandite	3.47	26.80	55.26	80.94
Pyrrhotite	55.05	83.33	91.91	91.20
Chalcopyrite	29.44	64.99	84.35	90.86
Silicates	98.07	98.37	99.18	99.35

North American Nickel
18559-01
MI5022-AUG21

High Definition Mineralogical Analysis using QEMSCAN (Quantitative
Evaluation of Materials by Scanning Electron Microscopy)

Cumulative Retained Grain Size Distribution

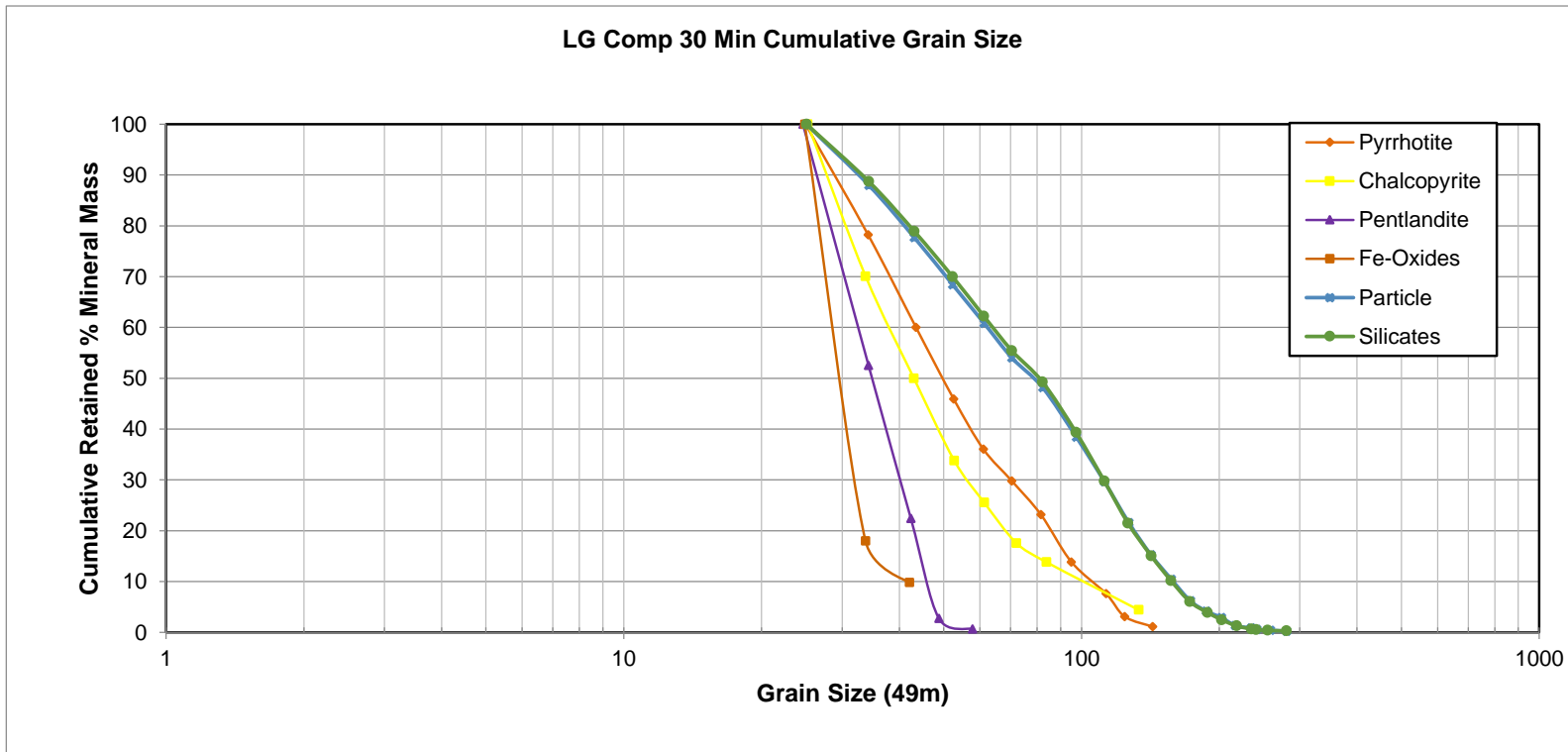

North American Nickel
 18559-01
 MI5022-AUG21

High Definition Mineralogical Analysis using QEMSCAN (Quantitative Evaluation of Materials by Scanning Electron Microscopy)

Copper Grade vs. Recovery: LG Comp 30 Min

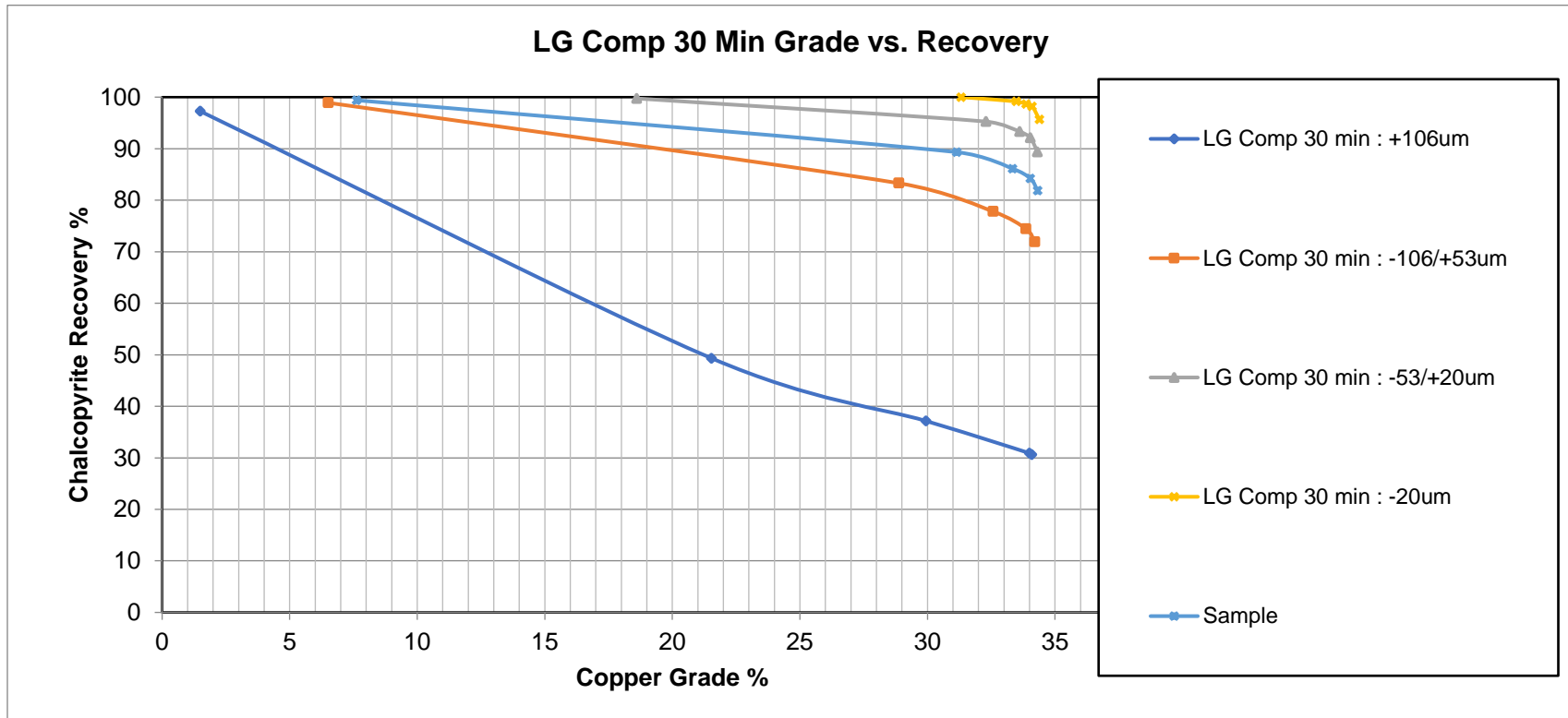

North American Nickel
 18559-01
 MI5022-AUG21

High Definition Mineralogical Analysis using QEMSCAN (Quantitative Evaluation of Materials by Scanning Electron Microscopy)

Nickle Grade vs. Recovery: LG Comp 30 Min

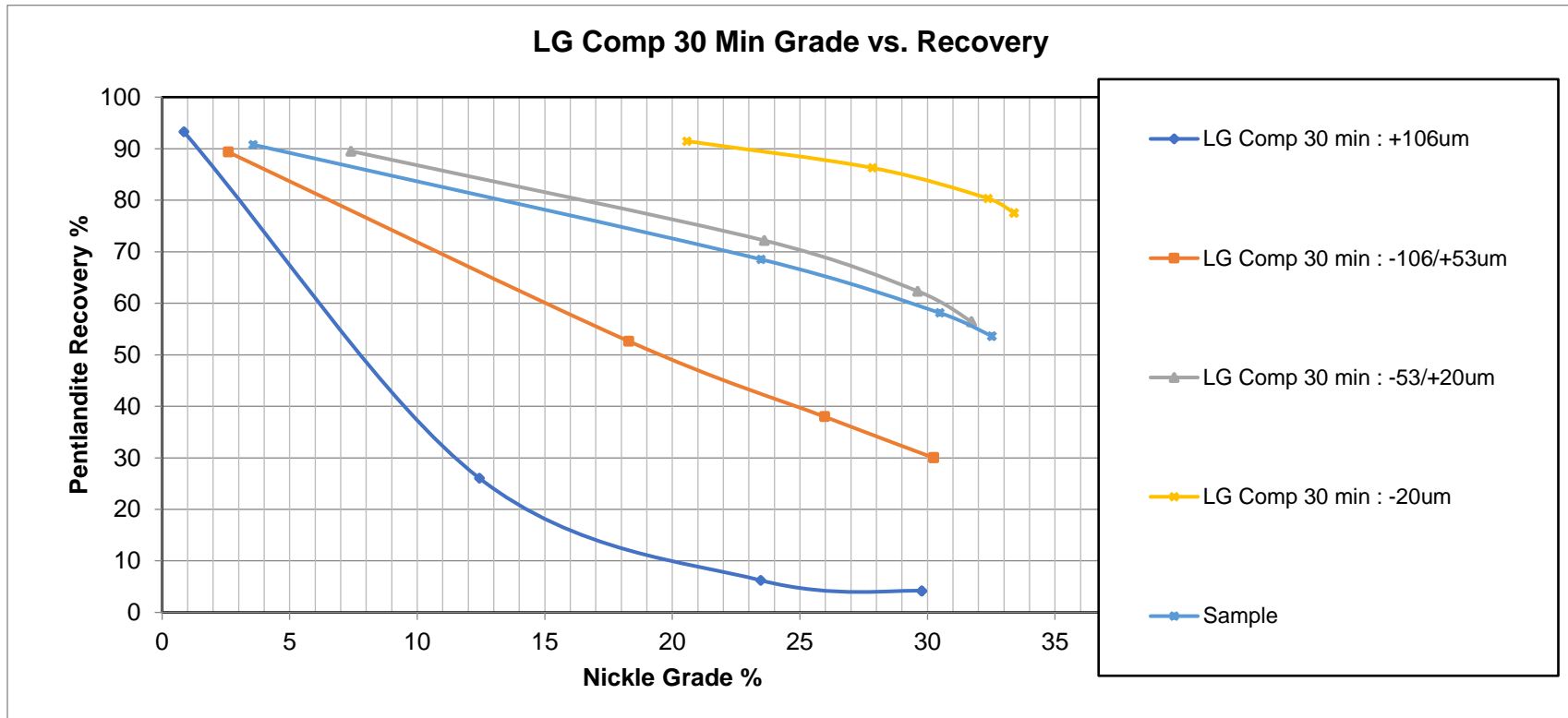



QEMSCAN DATA

prepared for:

North American Nickel

Project 18559-01

MI5001-SEP21

September 13, 2021

Prepared by:



Margot Aldis/Chris Gunning
Mineralogist/Senior Mineralogist

High Definition Mineralogical Analysis using QEMSCAN (Quantitative Evaluation of Materials by Scanning Electron Microscopy) (METH# 8.11.1) used by SGS Minerals Services

SGS Canada

P.O. Box 4300, 185 Concession Street, Lakefield, Ontario, Canada K0L 2H0
Tel. (705) 652-6365 www.sgs.com www.sgs.com/met
Member of the SGS Group (SGS SA)

North American Nickel
 18559-01
 MI5001-SEP21

High Definition Mineralogical Analysis using QEMSCAN (Quantitative Evaluation of Materials by Scanning Electron Microscopy)

Assay Reconciliation

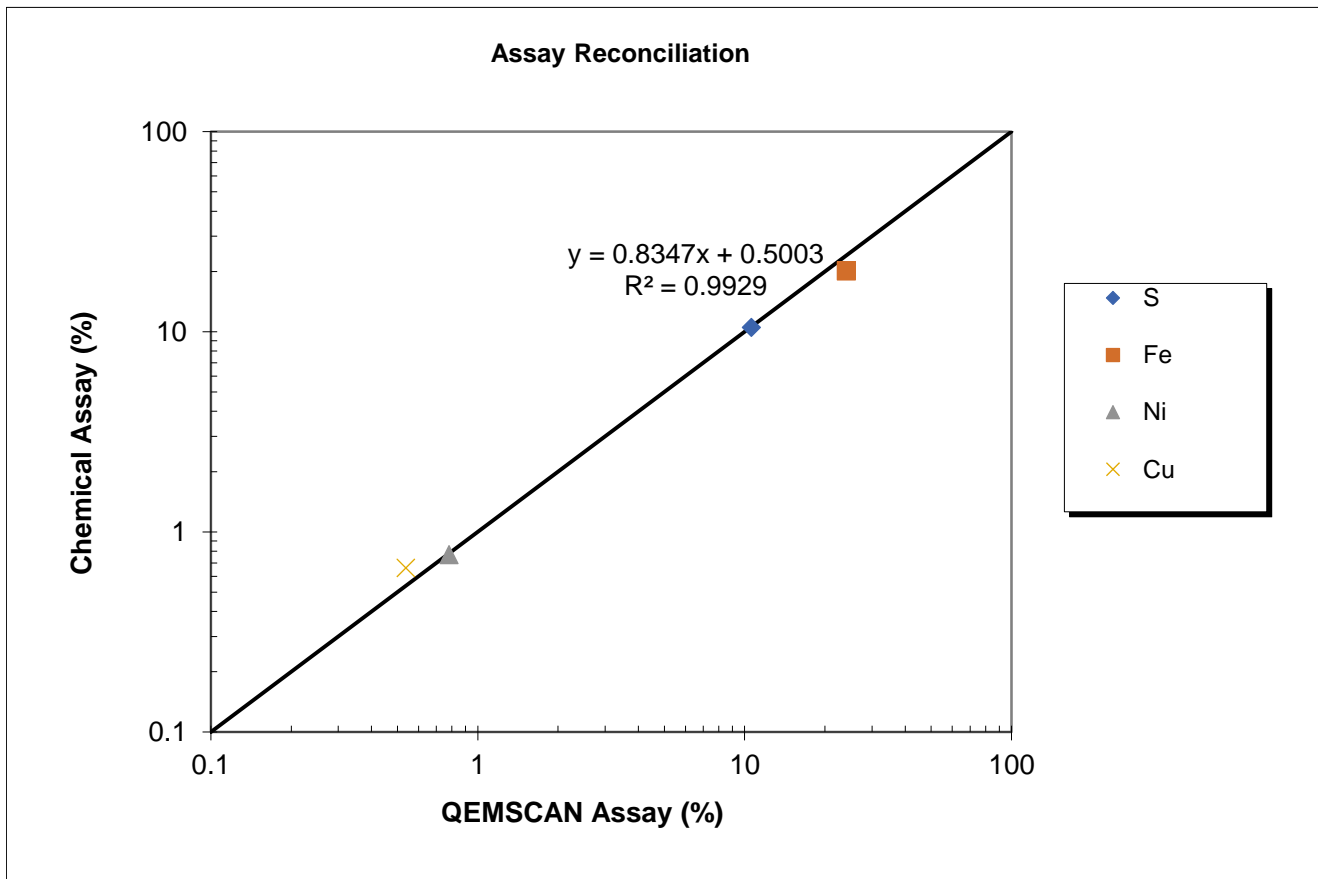

Sample	HG Comp 30 min 2nd Cut
Element	-300/+3um
S (QEMSCAN)	10.59
S (Chemical)	10.50
Fe (QEMSCAN)	24.07
Fe (Chemical)	20.10
Ni (QEMSCAN)	0.78
Ni (Chemical)	0.77
Cu (QEMSCAN)	0.54
Cu (Chemical)	0.66

North American Nickel
18559-01
MI5001-SEP21

High Definition Mineralogical Analysis using QEMSCAN (Quantitative Evaluation of Materials by Scanning Electron Microscopy)

Modals

Survey		18559-01 / MI5001-SEP21
Project		North American Nickel
Sample		HG Comp 30 min 2nd Cut
Fraction		-300/+3um
Mass Size Distribution (%)		100.0
Calculated ESD Particle Size		32
		Sample
Mineral	Pyrrhotite	22.69
Mass (%)	Chalcopyrite	1.39
	Pentlandite	1.93
	Pyrite/Marcasite	0.42
	Other_Sulphides	0.13
	Fe-Oxides	0.09
	Other_Oxides	0.00
	Chlorite/Clays	20.50
	Biotite	0.07
	Talc	0.15
	Quartz	2.40
	Plagioclase	10.66
	Amphibole/Pyroxene	14.96
	K-Feldspar	0.04
	Epidote	22.66
	Titanite/sphene	0.32
	Other Silicates	0.71
	Carbonates	0.77
	Apatite	0.03
	Other	0.08
	Total	100.00
Mean Grain Size by Frequency (µm)	Pyrrhotite	28
	Chalcopyrite	19
	Pentlandite	17
	Pyrite/Marcasite	9
	Other_Sulphides	8
	Fe-Oxides	9
	Other_Oxides	8
	Chlorite/Clays	16
	Biotite	13
	Talc	8
	Quartz	14
	Plagioclase	17
	Amphibole/Pyroxene	21
	K-Feldspar	9
	Epidote	19
	Titanite/sphene	15
	Other Silicates	9
	Carbonates	30
	Apatite	9
	Other	9

Modals - HG Comp 30 min 2nd Cut

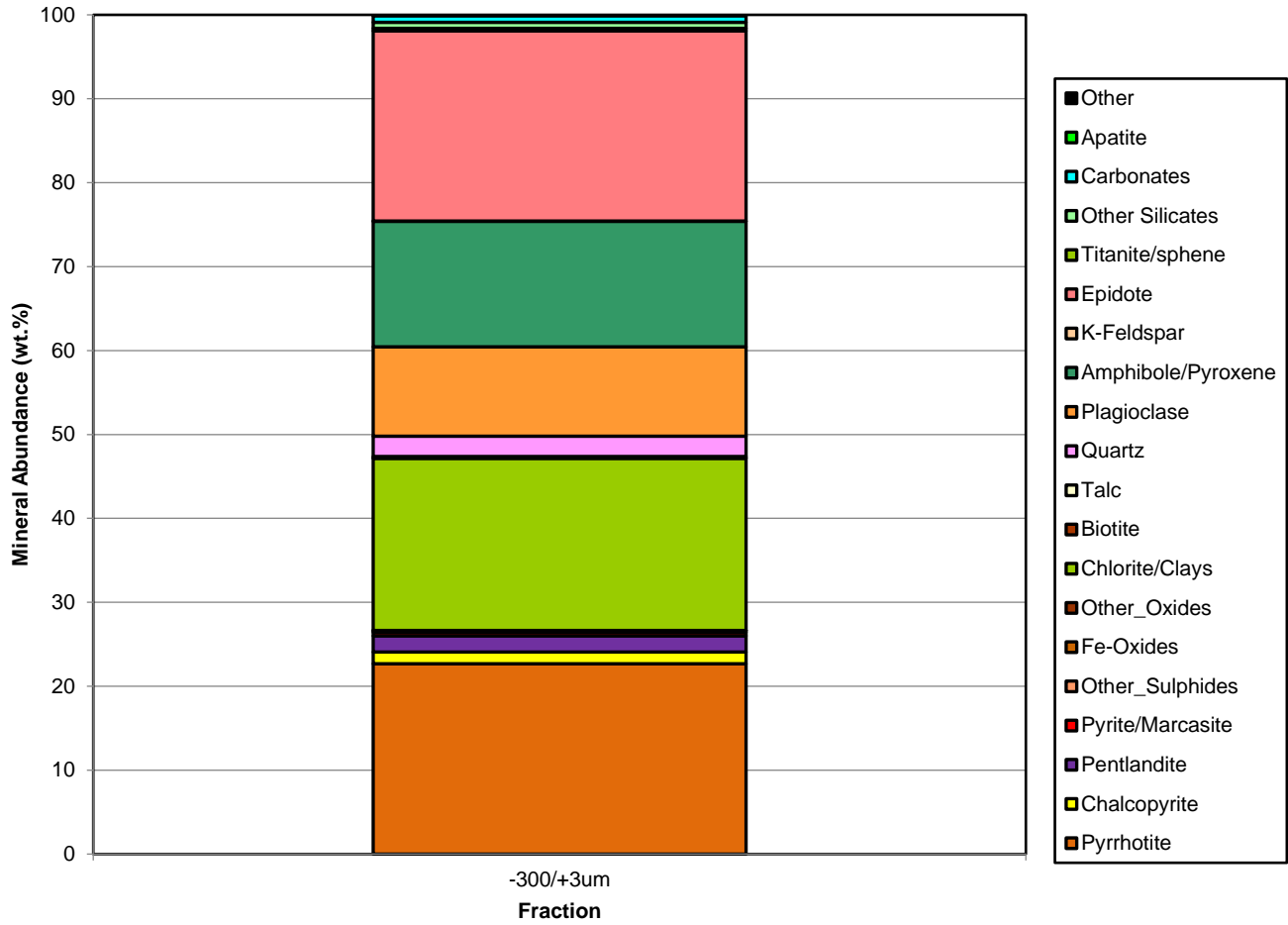

North American Nickel
 18559-01
 MI5001-SEP21

High Definition Mineralogical Analysis using QEMSCAN (Quantitative Evaluation of Materials by Scanning Electron Microscopy)

Cu Department - Absolute

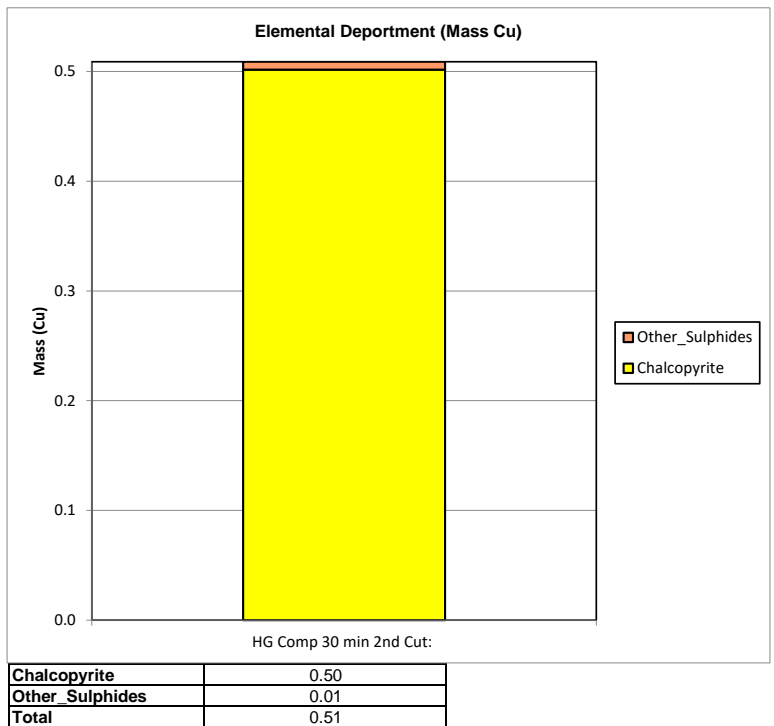

Cu Department - Normalized

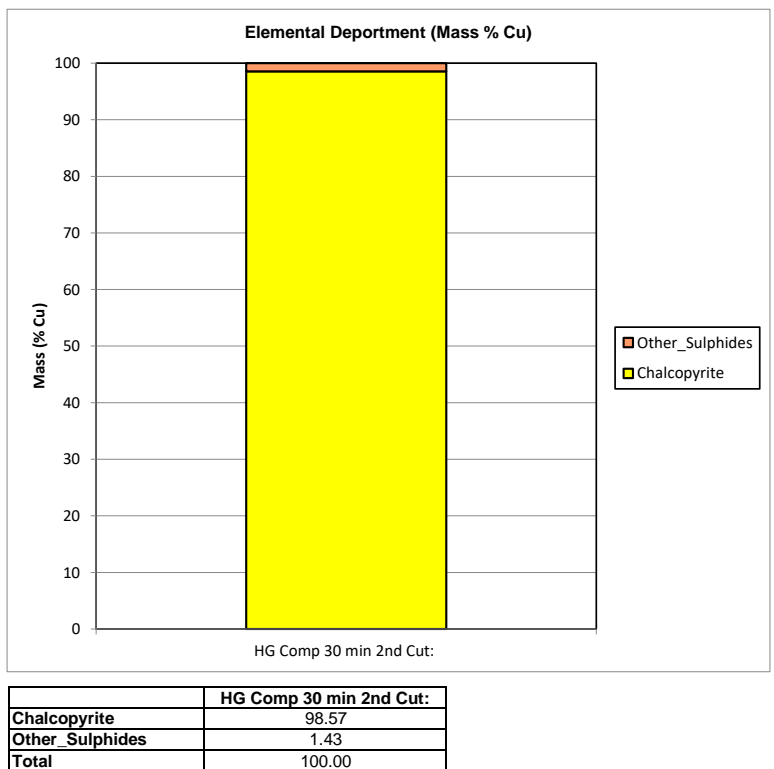

North American Nickel
 18559-01
 MI5001-SEP21

High Definition Mineralogical Analysis using QEMSCAN (Quantitative Evaluation of Materials by Scanning Electron Microscopy)

Ni Deportment - Absolute

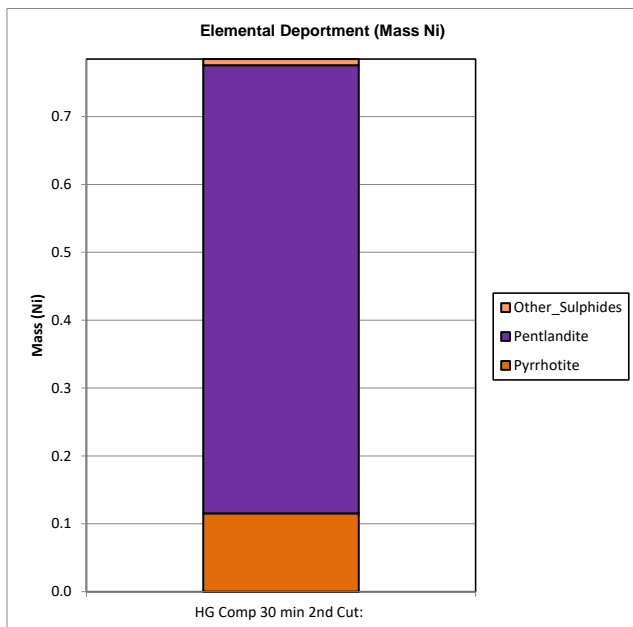

	HG Comp 30 min 2nd Cut:
Pyrrhotite	0.12
Pentlandite	0.66
Other_Sulphides	0.01
Total	0.78

Ni Deportment - Normalized

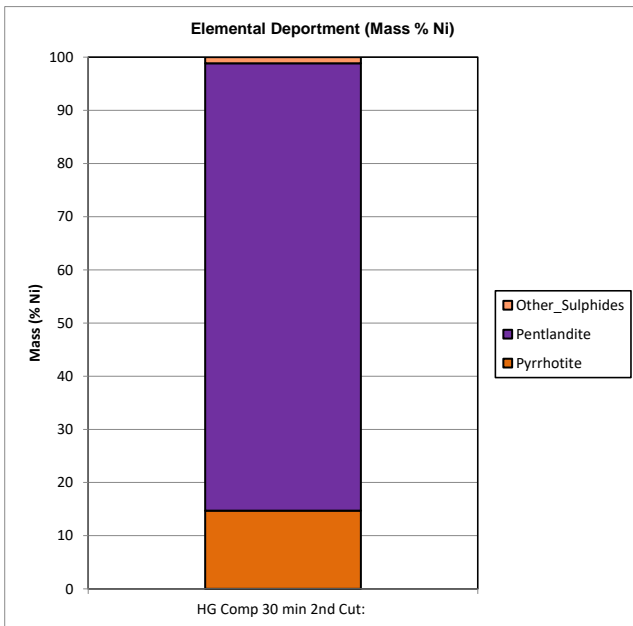

	HG Comp 30 min 2nd Cut:
Pyrrhotite	14.70
Pentlandite	84.14
Other_Sulphides	1.17
Total	100.00

North American Nickel
 18559-01
 MI5001-SEP21

High Definition Mineralogical Analysis using QEMSCAN (Quantitative Evaluation of Materials by Scanning Electron Microscopy)

Pentlandite Liberation

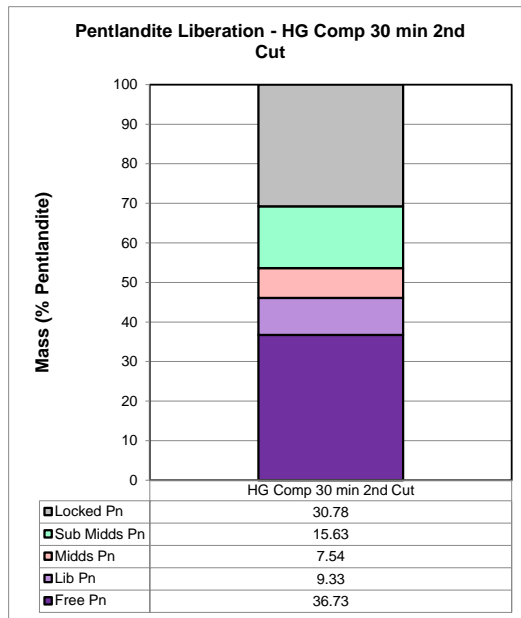
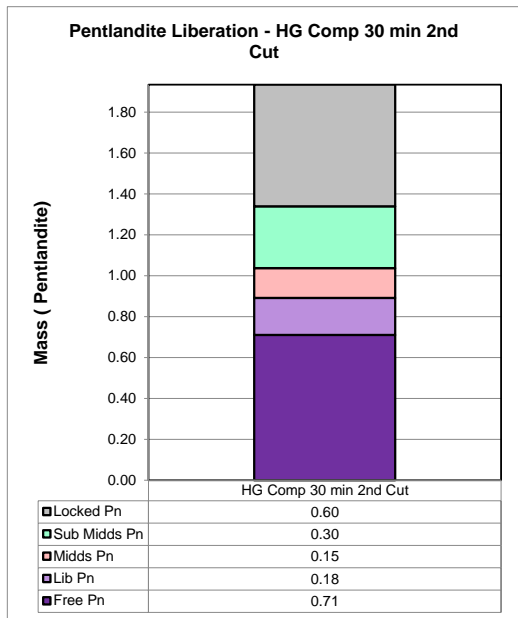

Absolute Mass of Pentlandite Across Fraction HG Comp 30

Mineral Name	HG Comp 30 min 2nd Cut
Free Pn	0.71
Lib Pn	0.18
Mids Pn	0.15
Sub Mids Pn	0.30
Locked Pn	0.60
Total	1.93
Total (% in fraction)	

Normalized Mass of Pentlandite Across Fraction HG Comp

Mineral Name	HG Comp 30 min 2nd Cut
Free Pn	36.73
Lib Pn	9.33
Mids Pn	7.54
Sub Mids Pn	15.63
Locked Pn	30.78
Total	100.0

North American Nickel
 18559-01
 MI5001-SEP21

High Definition Mineralogical Analysis using QEMSCAN (Quantitative Evaluation of Materials by Scanning Electron Microscopy)

Pentlandite Association

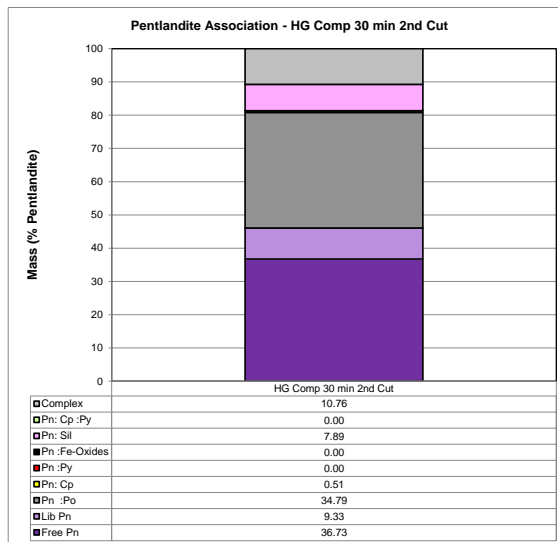
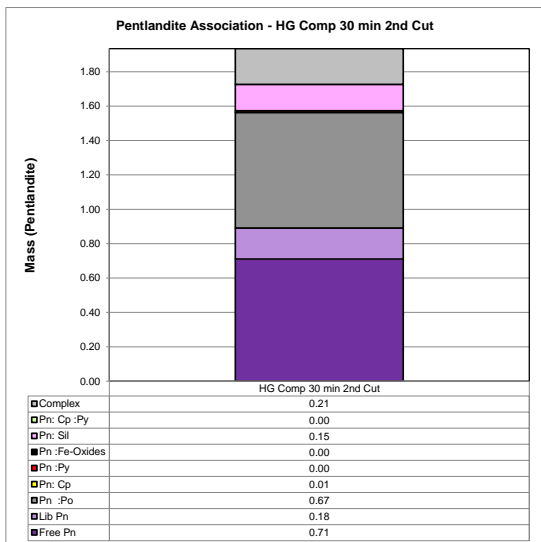

Absolute Mass of Pentlandite Across Fraction HG Co

Mineral Name	HG Comp 30 min 2nd Cut
Free Pn	0.71
Lib Pn	0.18
Pn :Po	0.67
Pn: Cp	0.01
Pn :Py	0.00
Pn :Fe-Oxides	0.00
Pn: Sil	0.15
Pn: Cp :Py	0.00
Complex	0.21
Total	1.93
Total (% in fraction)	

Normalized Mass of Pentlandite Across Fraction HG C

Mineral Name	HG Comp 30 min 2nd Cut
Free Pn	36.73
Lib Pn	9.33
Pn :Po	34.79
Pn: Cp	0.51
Pn :Py	0.00
Pn :Fe-Oxides	0.00
Pn: Sil	7.89
Pn: Cp :Py	0.00
Complex	10.76
Total	100.0
Liberated	46.05346913

North American Nickel
18555-01
MISO1-SEP21
High Definition Mineralogical Analysis using

Image Grid - Pentlandite Association

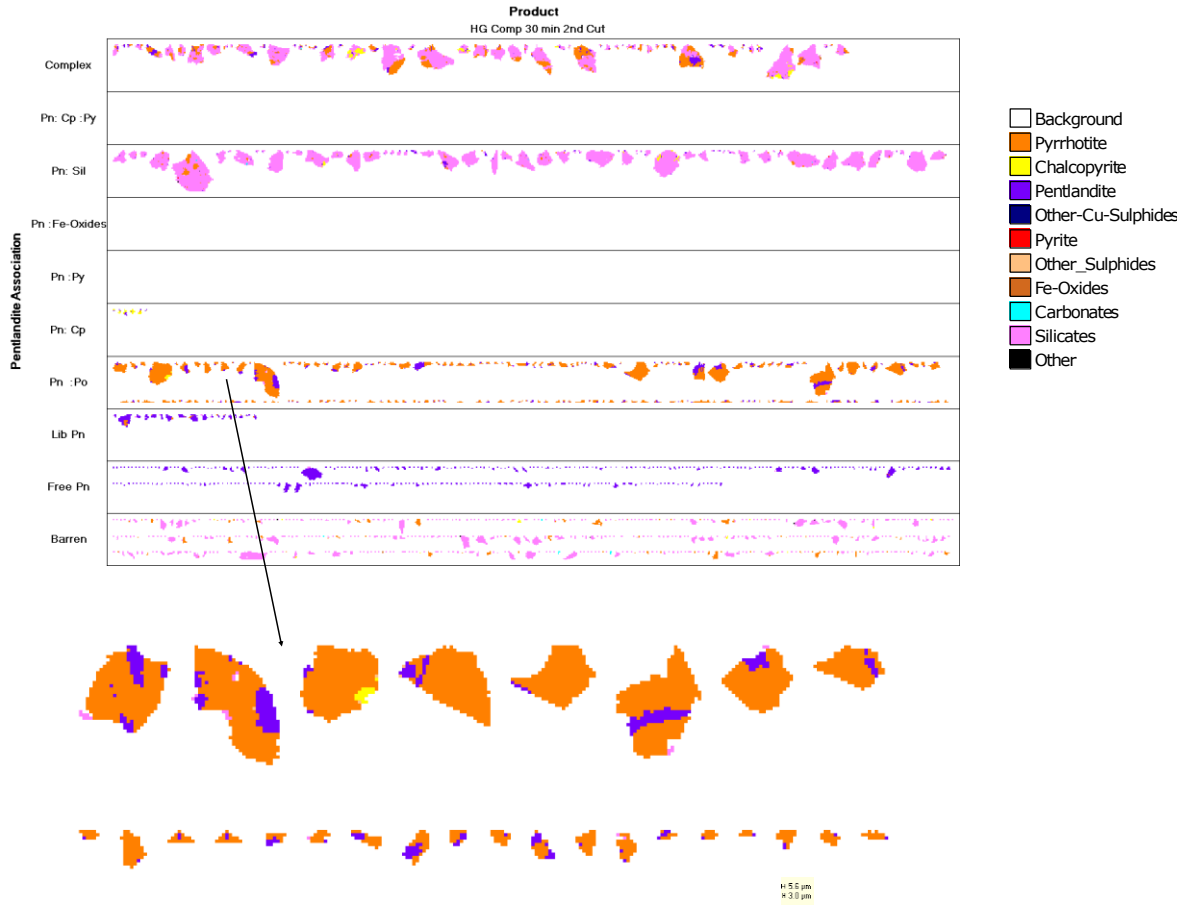

North American Nickel
 18559-01
 MI5001-SEP21

High Definition Mineralogical Analysis using QEMSCAN (Quantitative Evaluation of Materials by Scanning Electron Microscopy)

Pyrrhotite Liberation

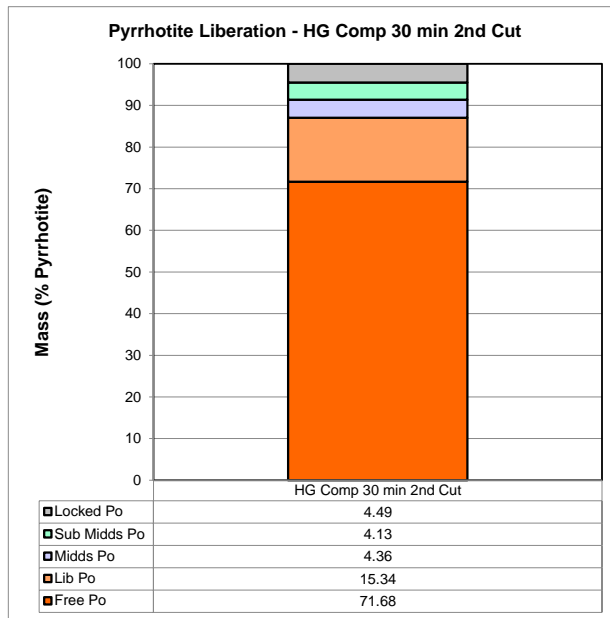
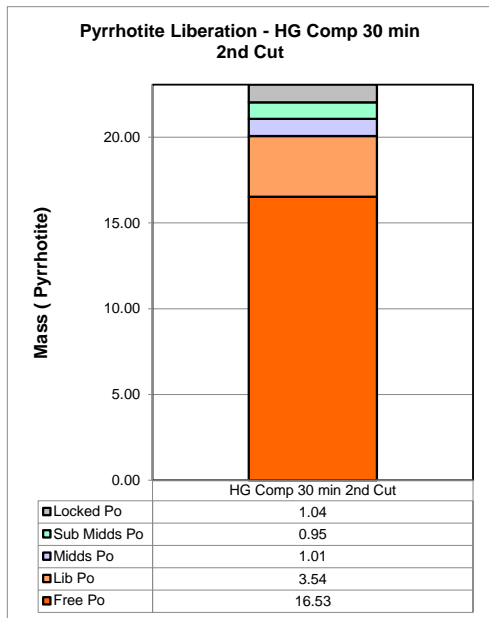

Absolute Mass of Pyrrhotite Across Fraction HG Comp

Mineral Name	HG Comp 30 min 2nd Cut
Free Po	16.53
Lib Po	3.54
Mids Po	1.01
Sub Mids Po	0.95
Locked Po	1.04
Total	23.07
Total (% in fraction)	

Normalized Mass of Pyrrhotite Across Fraction HG Comp 30 min 2nd C

Mineral Name	HG Comp 30 min 2nd Cut
Free Po	71.68
Lib Po	15.34
Mids Po	4.36
Sub Mids Po	4.13
Locked Po	4.49
Total	100.0

North American Nickel
18559-01
MI5001-SEP21

High Definition Mineralogical Analysis using QEMSCAN (Quantitative Evaluation of Materials by Scanning Electron Microscopy)

Pyrrhotite Association

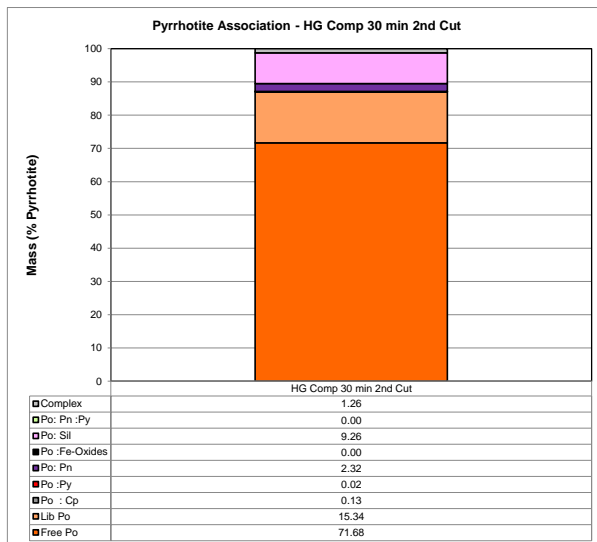
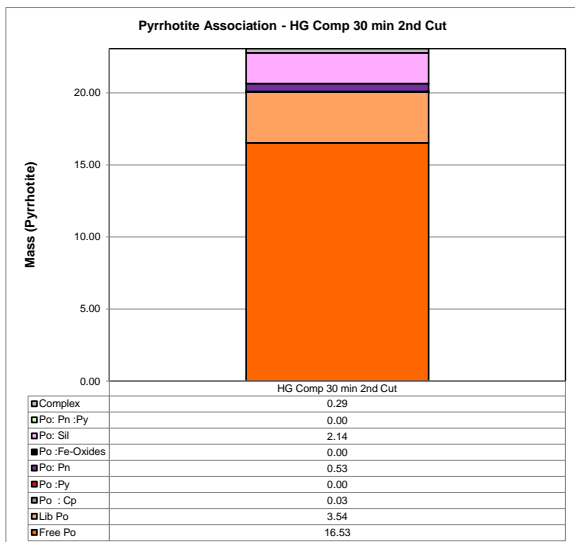

Absolute Mass of Pyrrhotite Across Fraction HG Comp 30 n

Mineral Name	HG Comp 30 min 2nd Cut
Free Po	16.53
Lib Po	3.54
Po : Cp	0.03
Po : Py	0.00
Po : Pn	0.53
Po : Fe-Oxides	0.00
Po : Sil	2.14
Po : Pn : Py	0.00
Complex	0.29
Total	23.07
Total (% in fraction)	

Normalized Mass of Pyrrhotite Across Fraction HG Comp 30 n

Mineral Name	HG Comp 30 min 2nd Cut
Free Po	71.68
Lib Po	15.34
Po : Cp	0.13
Po : Py	0.02
Po : Pn	2.32
Po : Fe-Oxides	0.00
Po : Sil	9.26
Po : Pn : Py	0.00
Complex	1.26
Total	100.0

Liberated 87.01945286

North American Nickel
18555-01
MISO01-SEP21
High Definition Mineralogical Analysis using

Imaeo Grid - Pyrrhotite Association

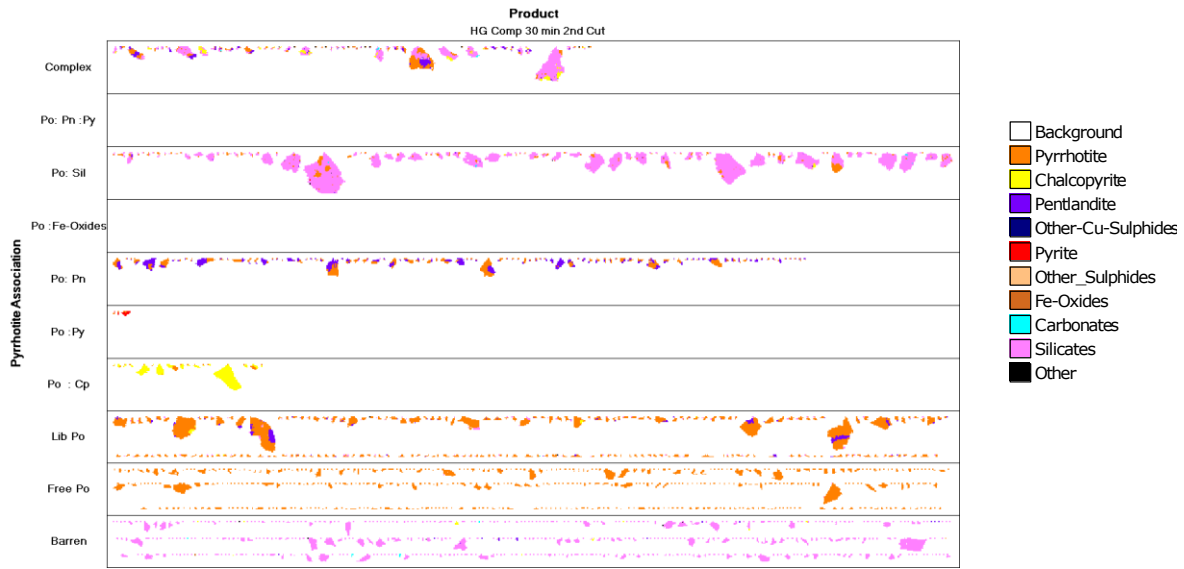

North American Nickel
 18559-01
 MI5001-SEP21

High Definition Mineralogical Analysis using QEMSCAN (Quantitative Evaluation of Materials by Scanning Electron Microscopy)

Chalcopyrite Liberation

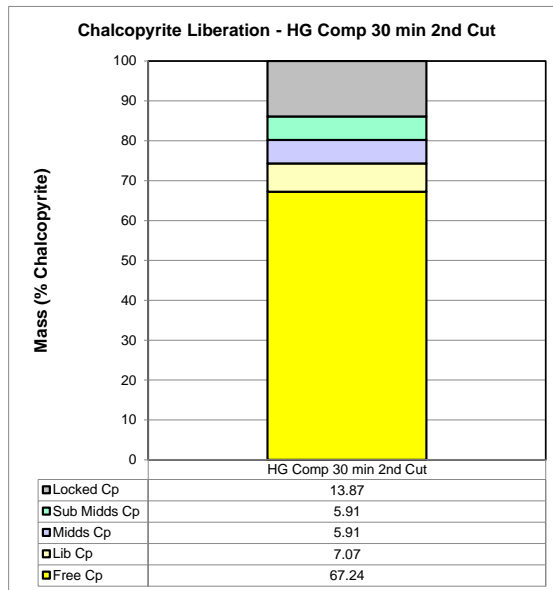
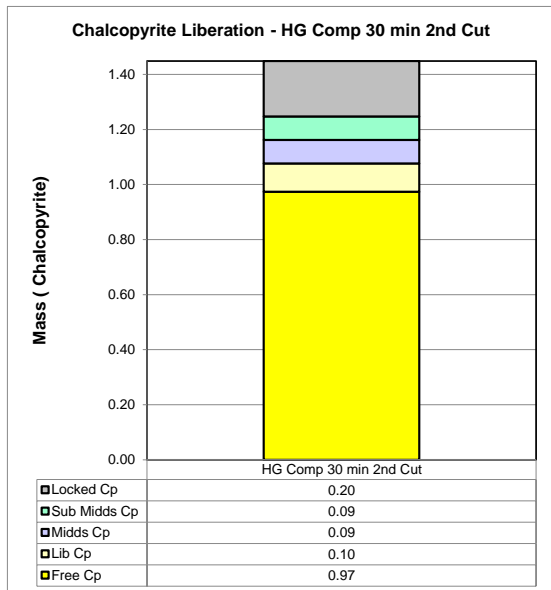

Absolute Mass of Chalcopyrite Across Fraction HG C

Mineral Name	HG Comp 30 min 2nd Cut
Free Cp	0.97
Lib Cp	0.10
Mids Cp	0.09
Sub Mids Cp	0.09
Locked Cp	0.20
Total	1.45

Total (% in fraction)

Normalized Mass of Chalcopyrite Across Fraction HG

Mineral Name	HG Comp 30 min 2nd Cut
Free Cp	67.24
Lib Cp	7.07
Mids Cp	5.91
Sub Mids Cp	5.91
Locked Cp	13.87
Total	100.0

North American Nickel
 18559-01
 MI5001-SEP21

High Definition Mineralogical Analysis using QEMSCAN (Quantitative Evaluation of Materials by Scanning Electron Microscopy)

Chalcopyrite Association

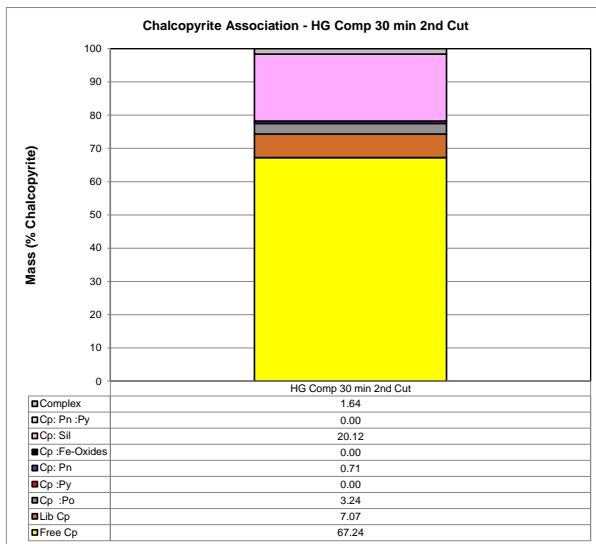
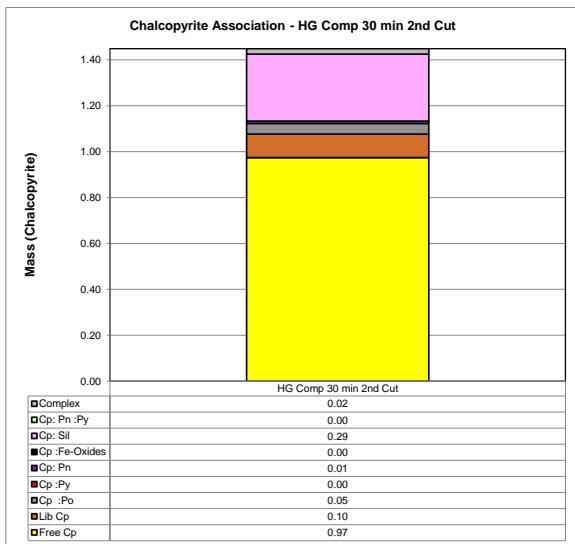

Absolute Mass of Chalcopyrite Across Fraction HG Comp 3

Mineral Name	HG Comp 30 min 2nd Cut
Free Cp	0.97
Lib Cp	0.10
Cp :Po	0.05
Cp :Py	0.00
Cp: Pn	0.01
Cp :Fe-Oxides	0.00
Cp: Sil	0.29
Cp: Pn :Py	0.00
Complex	0.02
Total	1.45
Total (% in fraction)	

Normalized Mass of Chalcopyrite Across Fraction HG Com

Mineral Name	HG Comp 30 min 2nd Cut
Free Cp	67.24
Lib Cp	7.07
Cp :Po	3.24
Cp :Py	0.00
Cp: Pn	0.71
Cp :Fe-Oxides	0.00
Cp: Sil	20.12
Cp: Pn :Py	0.00
Complex	1.64
Total	100.0

Liberated 67.23689104

North American Nickel
 18555-01
 MISOI-SEP21
 High Definition Mineralogical Analysis using

Inaa Grid - Chalcocovrite Association

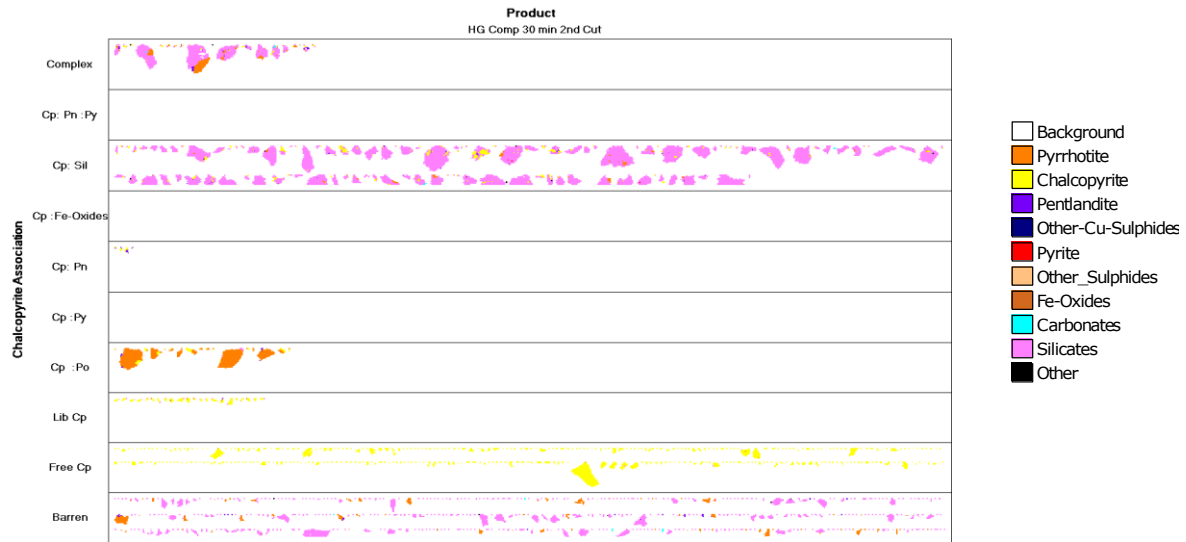

North American Nickel
 18559-01
 MI5001-SEP21

High Definition Mineralogical Analysis using QEMSCAN (Quantitative Evaluation of Materials by Scanning Electron Microscopy)

Silicates Liberation

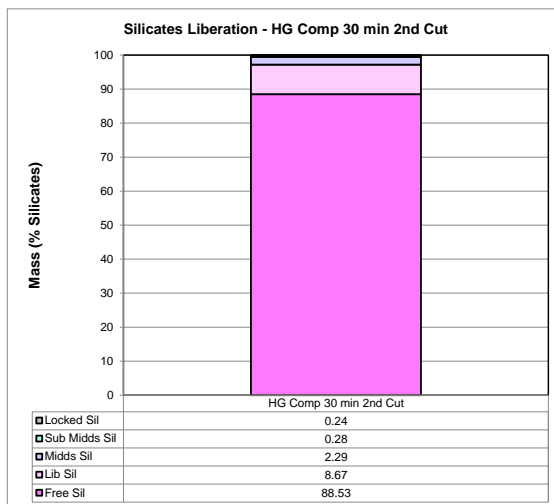
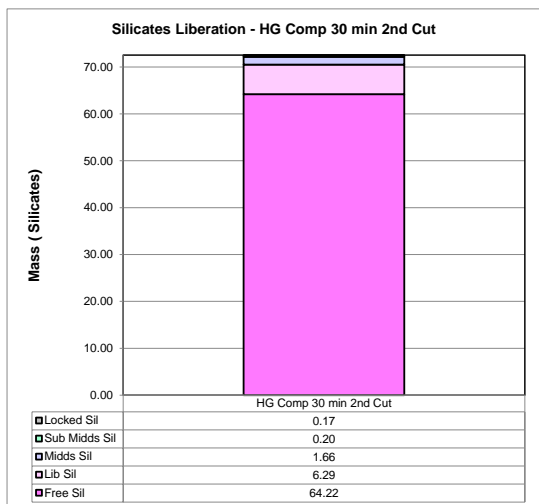

Absolute Mass of Silicates Across Fraction HG Comp 30 min 2nd

Mineral Name	HG Comp 30 min 2nd Cut
Free Sil	64.22
Lib Sil	6.29
Mids Sil	1.66
Sub Mids Sil	0.20
Locked Sil	0.17
Total	72.55
Total (% in fraction)	

Normalized Mass of Silicates Across Fraction HG Comp 30 min 2r

Mineral Name	HG Comp 30 min 2nd Cut
Free Sil	88.53
Lib Sil	8.67
Mids Sil	2.29
Sub Mids Sil	0.28
Locked Sil	0.24
Total	100.0

North American Nickel
18559-01
MI5001-SEP21

High Definition Mineralogical Analysis using QEMSCAN (Quantitative Evaluation of Materials by Scanning Electron Microscopy)

Silicates Association

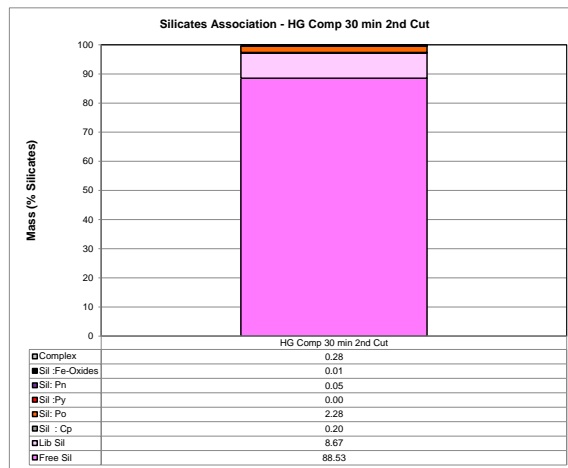
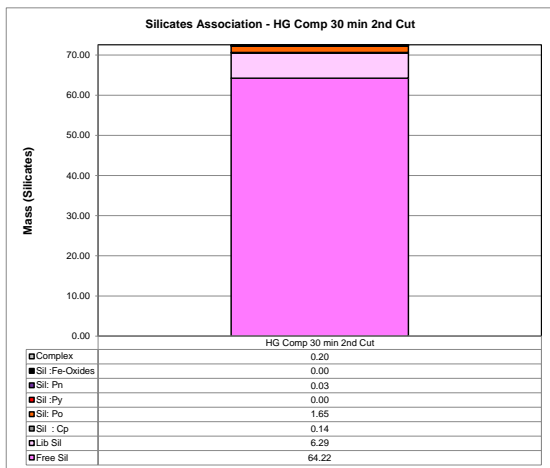

Absolute Mass of Silicates Across Fraction HG Comp 30 min 2nd

Mineral Name	HG Comp 30 min 2nd Cut
Free Sil	64.22
Lib Sil	6.29
Sil : Cp	0.14
Sil : Po	1.65
Sil : Py	0.00
Sil : Ph	0.03
Sil : Fe-Oxides	0.00
Complex	0.20
Total	72.55

Normalized Mass of Silicates Across Fraction HG Comp 30 min 2nd

Mineral Name	HG Comp 30 min 2nd Cut
Free Sil	88.53
Lib Sil	8.67
Sil : Cp	0.20
Sil : Po	2.28
Sil : Py	0.00
Sil : Ph	0.05
Sil : Fe-Oxides	0.01
Complex	0.28
Total	100.0

Liberated 97.19146676

North American Nickel
 18559-01
 MI5001-SEP21

High Definition Mineralogical Analysis using QEMSCAN (Quantitative Evaluation of Materials by Scanning Electron Microscopy)

Cumulative Retained Grain Size Distribution

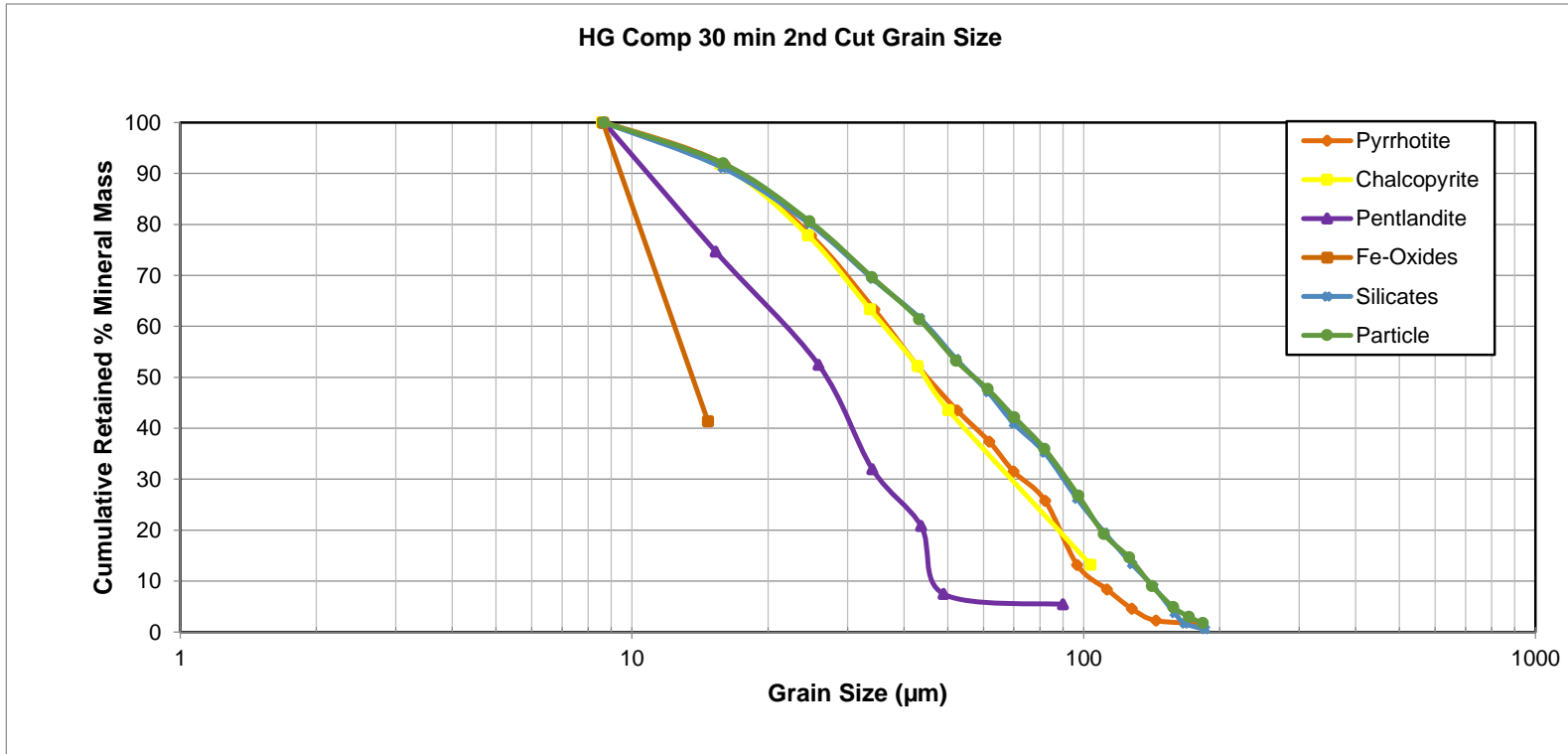

North American Nickel
18559-01
MI5001-SEP21

High Definition Mineralogical Analysis using QEMSCAN (Quantitative Evaluation of Materials by Scanning Electron Microscopy)

Nickle Grade vs. Pentlandite Recovery: HG Comp 30 min 2nd Cut

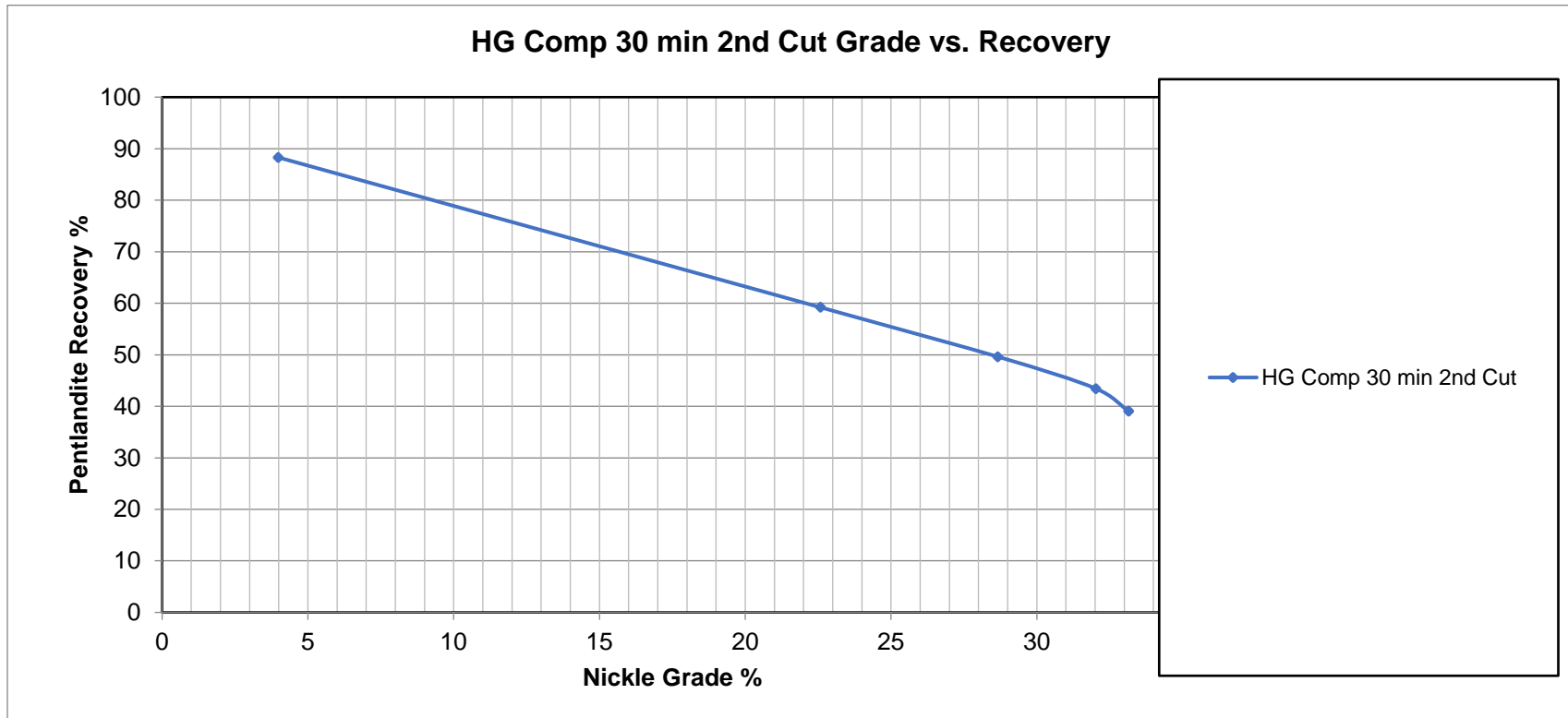

North American Nickel
18559-01
MI5001-SEP21

High Definition Mineralogical Analysis using QEMSCAN (Quantitative Evaluation of Materials by Scanning Electron Microscopy)

Copper Grade vs. Chalcopyrite Recovery: HG Comp 30 min 2nd Cut

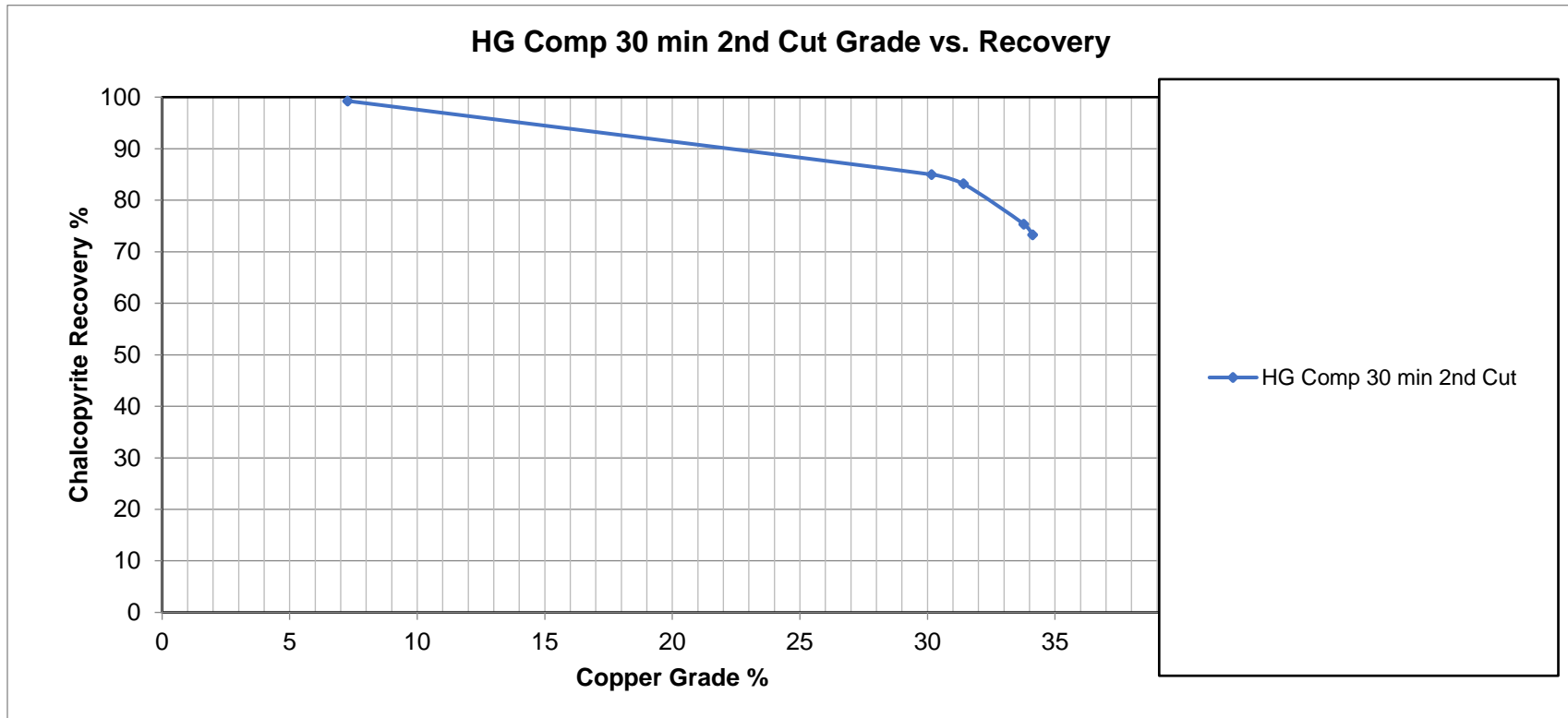

Appendix C – Grindability Testing

SMC Test - Test Definition Sheet			Version 2016 03 09																																																																																																	
Client:	North American Nickel			ERASE ALL DATA ENTRY FIELDS																																																																																																
SGS Project Name or Number:	18559-01																																																																																																			
Client Sample Identification:	HG Comp																																																																																																			
Deposit / Sample Source:	Phikwe Selebi																																																																																																			
Operator:	SR																																																																																																			
Test Date: ('dd/mm/yyyy')	16 August 2021	Machine ID:																																																																																																		
SGS Sample Number:																																																																																																				
Results for Test #	Eis (kWh/t)	t10	Mean Mass (g)																																																																																																	
1	0.247	7.375	54.425																																																																																																	
2	0.498	12.273	54.225																																																																																																	
3	0.999	25.360	54.350																																																																																																	
4	1.727	38.233	54.260																																																																																																	
5	2.463	45.769	54.390																																																																																																	
Mean SG	3.411																																																																																																			
Test Laboratory:	SGS Lakefield																																																																																																			
Language:	English																																																																																																			
Starting Material is:	Broken Rock																																																																																																			
Tests to be carried out on:	Broken Rock																																																																																																			
Select screen size range to be targeted: <small>(Select coarsest screen size possible, given the sample top size and amount available.)</small>	-31.5+26.5 mm																																																																																																			
Corresponding Nominal Core Diameter Targeted:	63.8 mm																																																																																																			
Estimate of Density for Sample Requirements:	2.7																																																																																																			
Approximate Length of Starting Material Required:	Not Applicable																																																																																																			
<table border="1" style="width: 100%; border-collapse: collapse;"> <thead> <tr> <th colspan="10">Target Particle Sizes</th> </tr> <tr> <th rowspan="2">Nominal Core Diam. (mm)</th> <th colspan="2">Target</th> <th rowspan="2">1/4 Core Length (mm)</th> <th rowspan="2">Tolerance (mm)</th> <th rowspan="2">Screen Aperture (mm)</th> <th colspan="2">Core Diameter Range</th> <th colspan="2">Core Volume Range</th> </tr> <tr> <th>Volume cu. cm</th> <th>Mass (g)</th> <th>Minimum (mm)</th> <th>Maximum (mm)</th> <th>Minimum (cu. cm)</th> <th>Maximum (cu. cm)</th> </tr> </thead> <tbody> <tr> <td>36.3</td> <td>2.1</td> <td>7.2</td> <td>8.1</td> <td>1</td> <td>1.41</td> <td>32.3</td> <td>39.4</td> <td>1.38</td> <td>2.83</td> </tr> <tr> <td>41.9</td> <td>3.6</td> <td>12.1</td> <td>10.3</td> <td>1.5</td> <td>1.68</td> <td>39.5</td> <td>45.4</td> <td>2.83</td> <td>4.78</td> </tr> <tr> <td>48.4</td> <td>6.0</td> <td>20.5</td> <td>13.1</td> <td>1.5</td> <td>2</td> <td>45.5</td> <td>52.7</td> <td>4.78</td> <td>8.18</td> </tr> <tr> <td>56.2</td> <td>10.4</td> <td>35.4</td> <td>16.7</td> <td>2</td> <td>2.4</td> <td>52.8</td> <td>60.3</td> <td>8.18</td> <td>13.42</td> </tr> <tr> <td>63.8</td> <td>16.5</td> <td>56.2</td> <td>20.6</td> <td>2</td> <td>2.8</td> <td>60.4</td> <td>69.4</td> <td>13.42</td> <td>22.33</td> </tr> <tr> <td>73.9</td> <td>28.2</td> <td>96.2</td> <td>26.3</td> <td>2.5</td> <td>3.35</td> <td>69.5</td> <td>79.9</td> <td>22.33</td> <td>37.39</td> </tr> <tr> <td>84.8</td> <td>46.6</td> <td>158.9</td> <td>32.9</td> <td>3</td> <td>3.96</td> <td>80.0</td> <td>89.1</td> <td>37.39</td> <td>55.76</td> </tr> </tbody> </table> <p>* For cores of less than 32 mm diameter, please refer to JKTech for recommendations.</p>					Target Particle Sizes										Nominal Core Diam. (mm)	Target		1/4 Core Length (mm)	Tolerance (mm)	Screen Aperture (mm)	Core Diameter Range		Core Volume Range		Volume cu. cm	Mass (g)	Minimum (mm)	Maximum (mm)	Minimum (cu. cm)	Maximum (cu. cm)	36.3	2.1	7.2	8.1	1	1.41	32.3	39.4	1.38	2.83	41.9	3.6	12.1	10.3	1.5	1.68	39.5	45.4	2.83	4.78	48.4	6.0	20.5	13.1	1.5	2	45.5	52.7	4.78	8.18	56.2	10.4	35.4	16.7	2	2.4	52.8	60.3	8.18	13.42	63.8	16.5	56.2	20.6	2	2.8	60.4	69.4	13.42	22.33	73.9	28.2	96.2	26.3	2.5	3.35	69.5	79.9	22.33	37.39	84.8	46.6	158.9	32.9	3	3.96	80.0	89.1	37.39	55.76
Target Particle Sizes																																																																																																				
Nominal Core Diam. (mm)	Target		1/4 Core Length (mm)	Tolerance (mm)	Screen Aperture (mm)	Core Diameter Range		Core Volume Range																																																																																												
	Volume cu. cm	Mass (g)				Minimum (mm)	Maximum (mm)	Minimum (cu. cm)	Maximum (cu. cm)																																																																																											
36.3	2.1	7.2	8.1	1	1.41	32.3	39.4	1.38	2.83																																																																																											
41.9	3.6	12.1	10.3	1.5	1.68	39.5	45.4	2.83	4.78																																																																																											
48.4	6.0	20.5	13.1	1.5	2	45.5	52.7	4.78	8.18																																																																																											
56.2	10.4	35.4	16.7	2	2.4	52.8	60.3	8.18	13.42																																																																																											
63.8	16.5	56.2	20.6	2	2.8	60.4	69.4	13.42	22.33																																																																																											
73.9	28.2	96.2	26.3	2.5	3.35	69.5	79.9	22.33	37.39																																																																																											
84.8	46.6	158.9	32.9	3	3.96	80.0	89.1	37.39	55.76																																																																																											
Click on this button to go to the Pre Start Check List. Print this out and complete it before you begin drop-testing.																																																																																																				
Click on this button if you wish to see the full SMC test procedure. This is now available via the internet.																																																																																																				
<p>Note: If the test is to be carried out on broken rock pieces, the largest screen size range possible should be selected, given the top size of the sample you are dealing with and the quantity available. If you have doubts about there being sufficient material to yield 100 particles from the selected size range, then you should switch to using the next lower size range.</p>																																																																																																				
<p>Step 1:</p> <p>There are two methods that can be used in the SMC test to generate the particles for breakage testing. The particles can either be cut pieces of quartered core or crushed pieces of either rock or core. The two methods are considered to be of equal accuracy, so which one is used is a matter of preference. The crush and particle select method is probably faster, so may be the preferred method when there is plenty of sample. To use this method you normally need about 20 kg, which is generally more than required for the cut core method, except when you are dealing with the largest diameter cores.</p> <p>When using the crush and particle select method, you should set the "Tests to be carried out on:" drop-down to "Broken Rock" and then select a size range from the "Select screen size to be targeted:" drop-down. The ideal size range if there is plenty of material available is the largest (ie. -31.5+26.5 mm). However, the test is most commonly carried out on -22.4+19 mm material and this is quite acceptable also. If sample quantity is very limited you may need to select the finest size range (-16+13.2 mm). Although the results are still acceptable, the test accuracy will not be quite as good using this size range, so it should only be used as a last resort when there is not enough sample to complete the test on a coarser size fraction.</p>																																																																																																				

SMC Test - Test Definition Sheet			Version 2016 03 09																																																																																																	
Client:	North American Nickel		ERASE ALL DATA ENTRY FIELDS																																																																																																	
SGS Project Name or Number:	18559-01																																																																																																			
Client Sample Identification:	LG Comp																																																																																																			
Deposit / Sample Source:	Phikwe Selebi																																																																																																			
Operator:	SR																																																																																																			
Test Date: ('dd/mm/yyyy')	16 August 2021	Machine ID:																																																																																																		
SGS Sample Number:																																																																																																				
Results for Test #	Eis (kWh/t)	t10	Mean Mass (g)																																																																																																	
1	0.248	5.875	51.520																																																																																																	
2	0.497	11.098	51.570																																																																																																	
3	0.997	20.679	51.455																																																																																																	
4	1.796	35.768	51.590																																																																																																	
5	2.595	45.655	51.600																																																																																																	
Mean SG	3.155																																																																																																			
Test Laboratory:	SGS Lakefield																																																																																																			
Language:	English		<p>Note: If the test is to be carried out on broken rock pieces, the largest screen size range possible should be selected, given the top size of the sample you are dealing with and the quantity available. If you have doubts about there being sufficient material to yield 100 particles from the selected size range, then you should switch to using the next lower size range.</p> <p>Step 1:</p> <p>There are two methods that can be used in the SMC test to generate the particles for breakage testing. The particles can either be cut pieces of quartered core or crushed pieces of either rock or core. The two methods are considered to be of equal accuracy, so which one is used is a matter of preference. The crush and particle select method is probably faster, so may be the preferred method when there is plenty of sample. To use this method you normally need about 20 kg, which is generally more than required for the cut core method, except when you are dealing with the largest diameter cores.</p> <p>When using the crush and particle select method, you should set the "Tests to be carried out on:" drop-down to "Broken Rock" and then select a size range from the "Select screen size to be targeted:" drop-down. The ideal size range if there is plenty of material available is the largest (ie. -31.5+26.5 mm). However, the test is most commonly carried out on -22.4+19 mm material and this is quite acceptable also. If sample quantity is very limited you may need to select the finest size range (-16+13.2 mm). Although the results are still acceptable, the test accuracy will not be quite as good using this size range, so it should only be used as a last resort when there is not enough sample to complete the test on a coarser size fraction.</p>																																																																																																	
Starting Material is:	Broken Rock																																																																																																			
Tests to be carried out on:	Broken Rock																																																																																																			
Select screen size range to be targeted: <small>(Select coarsest screen size possible, given the sample top size and amount available.)</small>	-31.5+26.5 mm																																																																																																			
Corresponding Nominal Core Diameter Targeted:	63.8 mm																																																																																																			
Estimate of Density for Sample Requirements:	2.7																																																																																																			
Approximate Length of Starting Material Required:	Not Applicable																																																																																																			
<table border="1" style="width: 100%; border-collapse: collapse;"> <thead> <tr> <th colspan="10">Target Particle Sizes</th> </tr> <tr> <th rowspan="2">Nominal Core Diam. (mm)</th> <th colspan="2">Target</th> <th rowspan="2">1/4 Core Length (mm)</th> <th rowspan="2">Tolerance (mm)</th> <th rowspan="2">Screen Aperture (mm)</th> <th colspan="2">Core Diameter Range</th> <th colspan="2">Core Volume Range</th> </tr> <tr> <th>Volume cu. cm</th> <th>Mass (g)</th> <th>Minimum (mm)</th> <th>Maximum (mm)</th> <th>Minimum (cu. cm)</th> <th>Maximum (cu. cm)</th> </tr> </thead> <tbody> <tr> <td>36.3</td> <td>2.1</td> <td>6.6</td> <td>8.1</td> <td>1</td> <td>1.41</td> <td>32.3</td> <td>39.4</td> <td>1.38</td> <td>2.83</td> </tr> <tr> <td>41.9</td> <td>3.6</td> <td>11.2</td> <td>10.3</td> <td>1.5</td> <td>1.68</td> <td>39.5</td> <td>45.4</td> <td>2.83</td> <td>4.78</td> </tr> <tr> <td>48.4</td> <td>6.0</td> <td>18.9</td> <td>13.1</td> <td>1.5</td> <td>2</td> <td>45.5</td> <td>52.7</td> <td>4.78</td> <td>8.18</td> </tr> <tr> <td>56.2</td> <td>10.4</td> <td>32.7</td> <td>16.7</td> <td>2</td> <td>2.4</td> <td>52.8</td> <td>60.3</td> <td>8.18</td> <td>13.42</td> </tr> <tr> <td>63.8</td> <td>16.5</td> <td>51.9</td> <td>20.6</td> <td>2</td> <td>2.8</td> <td>60.4</td> <td>69.4</td> <td>13.42</td> <td>22.33</td> </tr> <tr> <td>73.9</td> <td>28.2</td> <td>88.9</td> <td>26.3</td> <td>2.5</td> <td>3.35</td> <td>69.5</td> <td>79.9</td> <td>22.33</td> <td>37.39</td> </tr> <tr> <td>84.8</td> <td>46.6</td> <td>146.9</td> <td>32.9</td> <td>3</td> <td>3.96</td> <td>80.0</td> <td>89.1</td> <td>37.39</td> <td>55.76</td> </tr> </tbody> </table> <p>* For cores of less than 32 mm diameter, please refer to JKTech for recommendations.</p>					Target Particle Sizes										Nominal Core Diam. (mm)	Target		1/4 Core Length (mm)	Tolerance (mm)	Screen Aperture (mm)	Core Diameter Range		Core Volume Range		Volume cu. cm	Mass (g)	Minimum (mm)	Maximum (mm)	Minimum (cu. cm)	Maximum (cu. cm)	36.3	2.1	6.6	8.1	1	1.41	32.3	39.4	1.38	2.83	41.9	3.6	11.2	10.3	1.5	1.68	39.5	45.4	2.83	4.78	48.4	6.0	18.9	13.1	1.5	2	45.5	52.7	4.78	8.18	56.2	10.4	32.7	16.7	2	2.4	52.8	60.3	8.18	13.42	63.8	16.5	51.9	20.6	2	2.8	60.4	69.4	13.42	22.33	73.9	28.2	88.9	26.3	2.5	3.35	69.5	79.9	22.33	37.39	84.8	46.6	146.9	32.9	3	3.96	80.0	89.1	37.39	55.76
Target Particle Sizes																																																																																																				
Nominal Core Diam. (mm)	Target		1/4 Core Length (mm)	Tolerance (mm)	Screen Aperture (mm)	Core Diameter Range		Core Volume Range																																																																																												
	Volume cu. cm	Mass (g)				Minimum (mm)	Maximum (mm)	Minimum (cu. cm)	Maximum (cu. cm)																																																																																											
36.3	2.1	6.6	8.1	1	1.41	32.3	39.4	1.38	2.83																																																																																											
41.9	3.6	11.2	10.3	1.5	1.68	39.5	45.4	2.83	4.78																																																																																											
48.4	6.0	18.9	13.1	1.5	2	45.5	52.7	4.78	8.18																																																																																											
56.2	10.4	32.7	16.7	2	2.4	52.8	60.3	8.18	13.42																																																																																											
63.8	16.5	51.9	20.6	2	2.8	60.4	69.4	13.42	22.33																																																																																											
73.9	28.2	88.9	26.3	2.5	3.35	69.5	79.9	22.33	37.39																																																																																											
84.8	46.6	146.9	32.9	3	3.96	80.0	89.1	37.39	55.76																																																																																											
Click on this button to go to the Pre Start Check List. Print this out and complete it before you begin drop-testing.																																																																																																				
Click on this button if you wish to see the full SMC test procedure. This is now available via the internet.																																																																																																				

SGS Minerals Services

Standard Bond Rod Mill Grindability Test

Project No.: 18559-01 Date: 2-Sep-21
 Sample.: High Grade Laboratory: Lakefield (Canada)

Purpose: To determine the rod mill grindability of the sample in terms of a Bond work index number.

Procedure: The equipment and procedure duplicate the Bond method for determining rod mill work indices.

Test Conditions: Feed 100% Passing 0.5 inch
 Mesh of grind: 14 mesh
 Test feed weight (1250 mL): 2,654 grams
 Equivalent to : 2,123 kg/m³ at Minus 1/2"
 Weight % of the undersize material in the rod mill feed: 19.6%
 Weight of undersize product for 100% circulating load: 1,327 grams

Results: Gram per Rev Average for the Last Three Stages = **7.79 g**
 Circulation load = **98%**

CALCULATION OF A BOND WORK INDEX

$$RWI = \frac{62}{P_1^{0.23} \times Grp^{0.625} \times \left\{ \frac{10}{\sqrt{P}} - \frac{10}{\sqrt{F}} \right\}}$$

P₁ = 100% passing size of the product 1,180 microns
 Grp = Grams per revolution 7.79 grams
 P₈₀ = 80% passing size of product 902 microns
 F₈₀ = 80% passing size of the feed 10,486 microns

RWI = **14.4 kWh/ton (Imperial)**

RWI = **15.8 kWh/tonne (metric)**

Comments:

--

Stage No.	# of Revs	New Feed (grams)	Product in Feed (grams)	Material to Be Ground (grams)	Material Passing 14 mesh in Product (grams)	Net Ground Material (grams)	Material Ground Per Mill Rev (grams)
1	50	2,654	520	807	794	273	5.47
2	120	794	156	1,171	1,031	875	7.29
3	154	1,031	202	1,125	1,259	1,057	6.86
4	157	1,259	247	1,080	1,415	1,168	7.44
5	141	1,415	277	1,049	1,372	1,094	7.76
6	136	1,372	269	1,058	1,315	1,046	7.69
7	139	1,315	258	1,069	1,304	1,046	7.52
8	142	1,304	256	1,071	1,363	1,107	7.80
9	136	1,363	267	1,060	1,324	1,057	7.77
10	137	1,324	260	1,067	1,330	1,070	7.81

Average for Last Three Stages = 1,339 g 7.79 g

SGS Minerals Services

Standard Bond Rod Mill Grindability Test

Project No.: 18559-01
 Sample.: High Grade

Date: 2-Sep-21
 Laboratory: Lakefield (Canada)

Feed Particle Size Analysis

Size Mesh	µm	Weight grams	% Retained		% Passing Cumulative		
			Individual	Cumulative			
1/2"	12,700	0.0	0.0	0.0	100.0		
7/16"	11,200	197.9	15.1	15.1	84.9		
3/8"	9,500	154.0	11.7	26.8	73.2		
3	6,700	224.5	17.1	44.0	56.0		
4	4,750	158.8	12.1	56.1	43.9		
6	3,350	118.9	9.1	65.1	34.9		
8	2,360	87.4	6.7	71.8	28.2		
10	1,700	61.7	4.7	76.5	23.5		
14	1,180	51.0	3.9	80.4	19.6		
18	1,000	-	-	-	-		
20	850	44.7	3.4	83.8	16.2		
28	600	33.2	2.5	86.3	13.7		
35	425						
48	300						
65	212						
100	150						
Pan		179.2	13.7	100.0	-		
Total	-	1311.3	100.0	F₈₀: 10,486	354.9	100.0	P₈₀: 902

Product Particle Size Analysis

Weight grams	% Retained		% Passing Cumulative
	Individual	Cumulative	
0.0	0.0	0.0	100.0
42.4	11.9	11.9	88.1
43.8	12.3	24.3	75.7
53.3	15.0	39.3	60.7
40.3	11.4	50.7	49.3
31.6	8.9	59.6	40.4
24.2	6.8	66.4	33.6
19.1	5.4	71.8	28.2
100.2	28.2	100.0	-

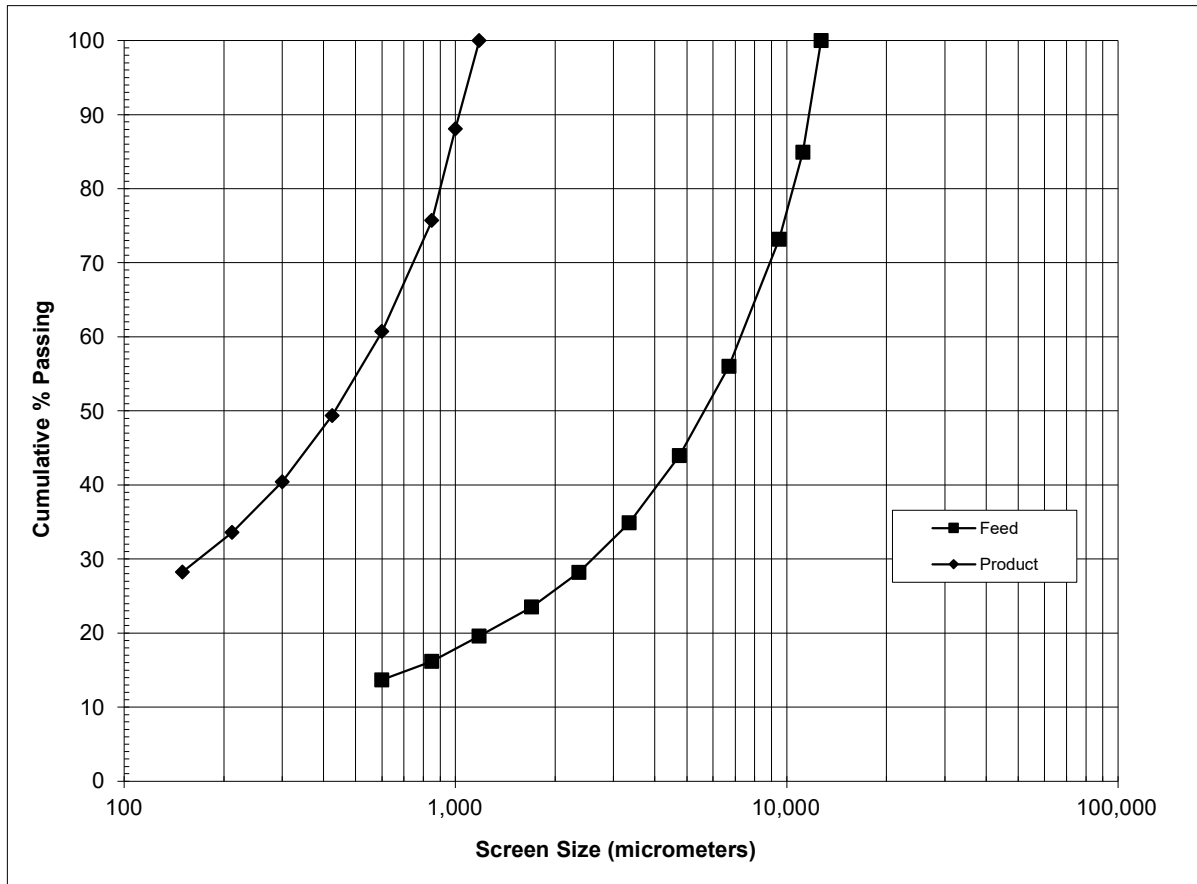

SGS Minerals Services

Standard Bond Rod Mill Grindability Test

Project No.: 18559-01 Date: 8-Sep-21
 Sample.: Low Grade Laboratory: Lakefield (Canada)

Purpose: To determine the rod mill grindability of the sample in terms of a Bond work index number.

Procedure: The equipment and procedure duplicate the Bond method for determining rod mill work indices.

Test Conditions: Feed 100% Passing 0.5 inch
 Mesh of grind: 14 mesh
 Test feed weight (1250 mL): 2,534 grams
 Equivalent to : 2,027 kg/m³ at Minus 1/2"
 Weight % of the undersize material in the rod mill feed: 15.9%
 Weight of undersize product for 100% circulating load: 1,267 grams

Results: Gram per Rev Average for the Last Three Stages = **5.98 g**
 Circulation load = **99%**

CALCULATION OF A BOND WORK INDEX

$$RWI = \frac{62}{P_1^{0.23} \times Grp^{0.625} \times \left\{ \frac{10}{\sqrt{P}} - \frac{10}{\sqrt{F}} \right\}}$$

P₁ = 100% passing size of the product 1,180 microns
 Grp = Grams per revolution 5.98 grams
 P₈₀ = 80% passing size of product 898 microns
 F₈₀ = 80% passing size of the feed 10,538 microns

RWI = **16.9 kWh/ton (Imperial)**

RWI = **18.6 kWh/tonne (metric)**

Comments:

--

Stage No.	# of Revs	New Feed (grams)	Product in Feed (grams)	Material to Be Ground (grams)	Material Passing 14 mesh in Product (grams)	Net Ground Material (grams)	Material Ground Per Mill Rev (grams)
1	50	2,534	403	864	629	226	4.51
2	110	629	100	1,167	672	572	5.20
3	223	672	107	1,160	1,278	1,171	5.25
4	203	1,278	203	1,064	1,384	1,180	5.82
5	180	1,384	220	1,047	1,293	1,073	5.96
6	178	1,293	206	1,061	1,281	1,075	6.04
7	176	1,281	204	1,063	1,251	1,047	5.95

Average for Last Three Stages = 1,275 g 5.98 g

SGS Minerals Services

Standard Bond Rod Mill Grindability Test

Project No.: 18559-01
 Sample.: Low Grade

Date: 8-Sep-21
 Laboratory: Lakefield (Canada)

Feed Particle Size Analysis

Size Mesh	Size μm	Weight grams	% Retained Individual	% Retained Cumulative	% Passing Cumulative		
1/2"	12,700	0.0	0.0	0.0	100.0		
7/16"	11,200	186.7	14.3	14.3	85.7		
3/8"	9,500	190.3	14.6	28.9	71.1		
3	6,700	241.2	18.5	47.3	52.7		
4	4,750	158.2	12.1	59.4	40.6		
6	3,350	123.8	9.5	68.9	31.1		
8	2,360	90.2	6.9	75.8	24.2		
10	1,700	62.7	4.8	80.6	19.4		
14	1,180	45.5	3.5	84.1	15.9		
18	1,000	-	-	-	-		
20	850	39.7	3.0	87.1	12.9		
28	600	29.2	2.2	89.4	10.6		
35	425						
48	300						
65	212						
100	150						
Pan		139.0	10.6	100.0	-		
Total	-	1306.5	100.0	F₈₀: 10,538	355.6	100.0	P₈₀: 898

Product Particle Size Analysis

Weight grams	% Retained Individual	% Retained Cumulative	% Passing Cumulative
0.0	0.0	0.0	100.0
42.3	11.9	11.9	88.1
42.7	12.0	23.9	76.1
53.3	15.0	38.9	61.1
41.3	11.6	50.5	49.5
32.5	9.1	59.6	40.4
24.5	6.9	66.5	33.5
19.0	5.3	71.9	28.1
100.0	28.1	100.0	-

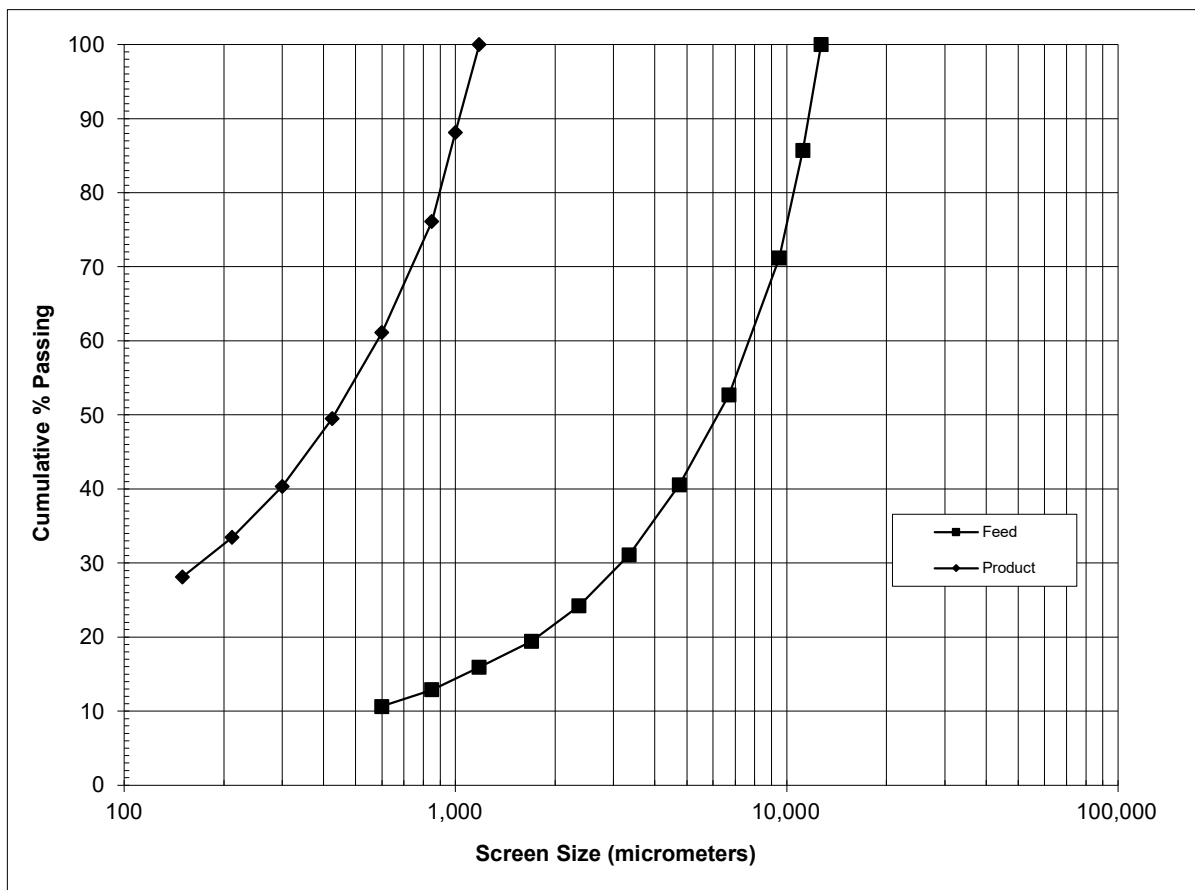

Standard Bond Ball Mill Grindability Test

Project No.: 18559-01 Date: 10-Sep-21
 Sample: HG COMP Laboratory: Lakefield (Canada)

Purpose: The equipment and procedure duplicate the Bond method for determining ball mill work indices.

Procedure: The equipment and procedure duplicate the Bond method for determining ball mill work indices.

Test Conditions: Feed 100% Passing 6 mesh
 Mesh of grind: 100 mesh
 Test feed weight (700 mL): 1,502 grams
 Equivalent to : 2,145 kg/m³ at Minus 6 mesh
 Weight % of the undersize material in the ball mill feed: 12.7%
 Weight of undersize product for 250% circulating load: 429 grams

Results: Gram per Rev Average for the Last Three Stages = **1.42 g**
 Circulation load = **254%**

CALCULATION OF A BOND WORK INDEX

$$BWI = \frac{44.5}{P_1^{0.23} \times Grp^{0.82} \times \left\{ \frac{10}{\sqrt{P}} - \frac{10}{\sqrt{F}} \right\}}$$

P₁ = 100% passing size of the product 150 microns
 Grp = Grams per revolution 1.42 grams
 P₈₀ = 80% passing size of product 118 microns
 F₈₀ = 80% passing size of the feed 2,607 microns

BWI = **14.5 kWh/ton (Imperial)**

BWI = **16.0 kWh/tonne (metric)**

Comments:

cycle four did not top up feed.

Stage No.	# of Revs	New Feed (grams)	Product in Feed (grams)	Material to Be Ground (grams)	Material Passing 100 mesh in Product (grams)	Net Ground Material (grams)	Material Ground Per Mill Rev (grams)
1	100	1,502	191	238	345	154	1.54
2	251	345	44	385	362	318	1.27
3	303	362	46	383	440	394	1.30
4	287	440	56	373	777	721	2.51
5	132	777	99	330	304	205	1.55
6	252	304	39	390	414	375	1.49
7	253	414	53	376	415	362	1.43
8	263	415	53	376	423	370	1.41
9	267	423	54	375	436	382	1.43

Average for Last Three Stages = 424 g 1.42 g

Standard Bond Ball Mill Grindability Test

Project No.: 18559-01
 Sample: HG COMP

Date: 10-Sep-21
 Laboratory: Lakefield (Canada)

Feed Particle Size Analysis

Mesh	Size µm	Weight grams	% Retained		% Passing Cumulative
			Individual	Cumulative	
6	3,360	0.0	0.0	0.0	100.0
7	2,800	90.2	13.8	13.8	86.2
8	2,360	92.0	14.1	27.9	72.1
10	1,700	118.2	18.1	46.0	54.0
14	1,180	83.2	12.7	58.7	41.3
20	850	46.9	7.2	65.9	34.1
28	600	39.8	6.1	72.0	28.0
35	425	32.9	5.0	77.0	23.0
48	300	27.7	4.2	81.2	18.8
65	212	20.6	3.2	84.4	15.6
100	150	19.0	2.9	87.3	12.7
115	125	-	-	88.6	11.4
150	106	14.9	2.3	89.6	10.4
200	75				
270	53				
400	38				
Pan	-	68.2	10.4	100.0	-
Total	-	653.6	100.0	F₈₀: 2,607	152.0

Product Particle Size Analysis

Weight grams	% Retained		% Passing Cumulative
	Individual	Cumulative	
0.0	0.0	0.0	100.0
0.0	0.0	0.0	100.0
24.8	16.3	16.3	83.7
14.9	9.8	26.1	73.9
22.8	15.0	41.1	58.9
16.6	10.9	52.0	48.0
12.9	8.5	60.5	39.5
60.0	39.5	100.0	-
152.0	100.0	P₈₀: 118	

Values in italics were interpolated

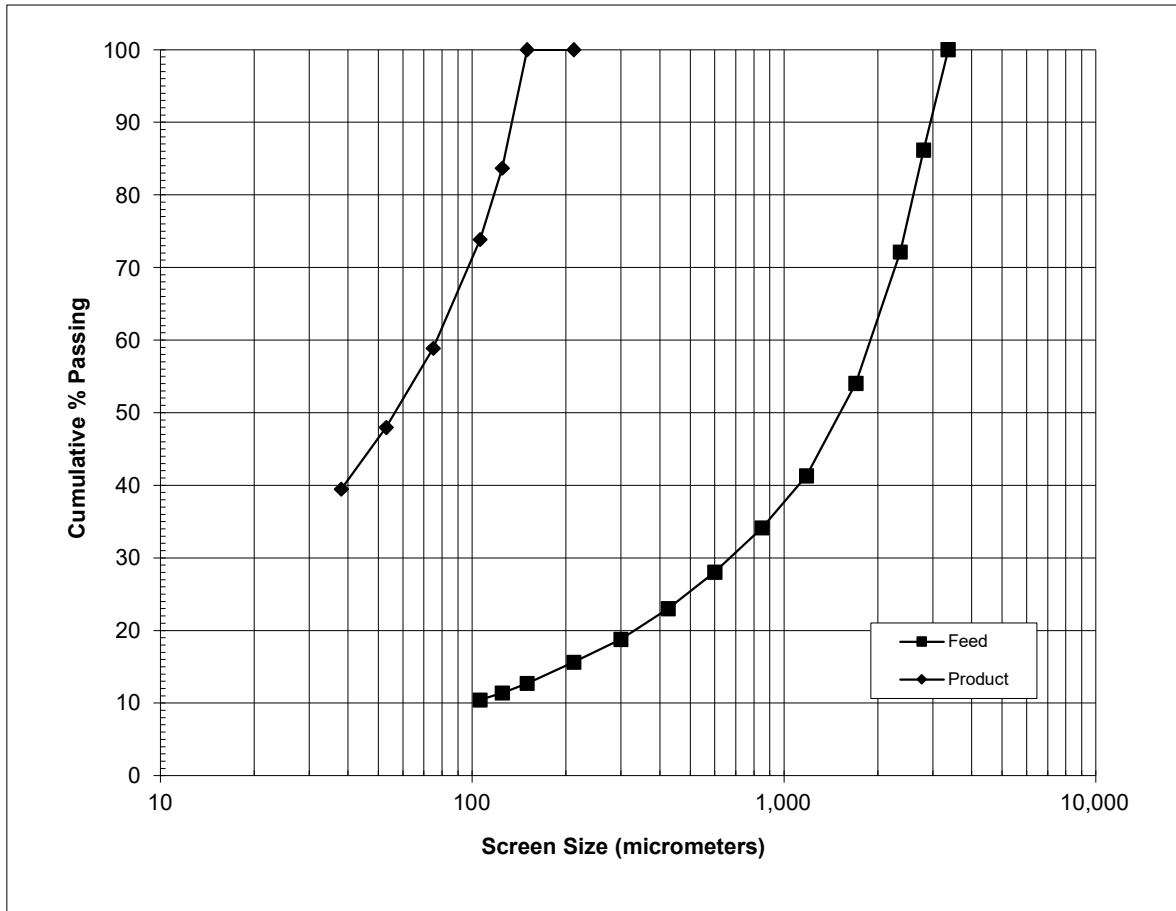

Standard Bond Ball Mill Grindability Test

Project No.: 18559-01 Date: 16-Sep-21
 Sample: LG Comp Laboratory: Lakefield (Canada)

Purpose: The equipment and procedure duplicate the Bond method for determining ball mill work indices.

Procedure: The equipment and procedure duplicate the Bond method for determining ball mill work indices.

Test Conditions: Feed 100% Passing 6 mesh
 Mesh of grind: 100 mesh
 Test feed weight (700 mL): 1,341 grams
 Equivalent to : 1,916 kg/m³ at Minus 6 mesh
 Weight % of the undersize material in the ball mill feed: 11.2%
 Weight of undersize product for 250% circulating load: 383 grams

Results: Gram per Rev Average for the Last Three Stages = **1.02 g**
 Circulation load = **250%**

CALCULATION OF A BOND WORK INDEX

$$BWI = \frac{44.5}{P_1^{0.23} \times Grp^{0.82} \times \left\{ \frac{10}{\sqrt{P}} - \frac{10}{\sqrt{F}} \right\}}$$

P₁ = 100% passing size of the product 150 microns
 Grp = Grams per revolution 1.02 grams
 P₈₀ = 80% passing size of product 106 microns
 F₈₀ = 80% passing size of the feed 2,599 microns

BWI = **17.8 kWh/ton (Imperial)**

BWI = **19.6 kWh/tonne (metric)**

Comments:

Stage No.	# of Revs	New Feed (grams)	Product in Feed (grams)	Material to Be Ground (grams)	Material Passing 100 mesh in Product (grams)	Net Ground Material (grams)	Material Ground Per Mill Rev (grams)
1	100	1,341	150	233	270	120	1.20
2	294	270	30	353	328	298	1.01
3	342	328	37	346	372	335	0.98
4	348	372	42	342	395	353	1.02
5	334	395	44	339	385	341	1.02
6	333	385	43	340	387	344	1.03
7	329	387	43	340	378	335	1.02

Average for Last Three Stages = 383 g 1.02 g

Standard Bond Ball Mill Grindability Test

Project No.: 18559-01
 Sample: LG Comp

Date: 16-Sep-21
 Laboratory: Lakefield (Canada)

Feed Particle Size Analysis

Mesh	Size µm	Weight grams	% Retained		% Passing Cumulative
			Individual	Cumulative	
6	3,360	0.0	0.0	0.0	100.0
7	2,800	84.2	13.1	13.1	86.9
8	2,360	96.4	15.0	28.1	71.9
10	1,700	128.8	20.1	48.2	51.8
14	1,180	85.2	13.3	61.5	38.5
20	850	46.6	7.3	68.7	31.3
28	600	37.2	5.8	74.5	25.5
35	425	30.8	4.8	79.3	20.7
48	300	24.7	3.8	83.1	16.9
65	212	19.5	3.0	86.2	13.8
100	150	16.9	2.6	88.8	11.2
115	125	-	-	90.0	10.0
150	106	13.0	2.0	90.8	9.2
200	75				
270	53				
400	38				
Pan	-	58.8	9.2	100.0	-
Total	-	642.1	100.0	F₈₀: 2,599	156.4

Product Particle Size Analysis

Weight grams	% Retained		% Passing Cumulative
	Individual	Cumulative	
0.0	0.0	0.0	100.0
0.0	0.0	0.0	100.0
16.5	10.5	10.5	89.5
14.7	9.4	19.9	80.1
23.2	14.8	34.8	65.2
15.6	10.0	44.8	55.2
13.3	8.5	53.3	46.7
73.1	46.7	100.0	-
P₈₀: 106			

Values in italics were interpolated

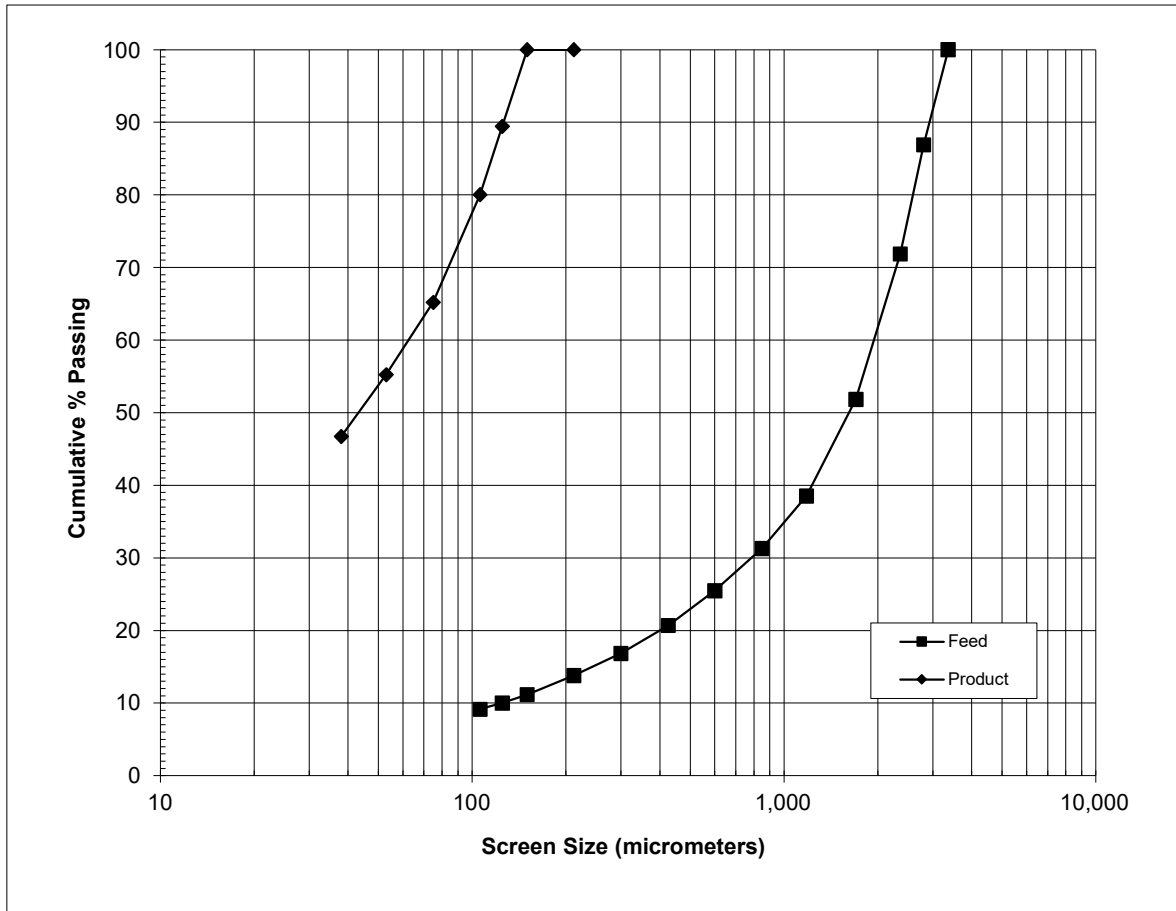

SGS Minerals Services

STANDARD BOND ABRASION TEST

Project No.: 18559-01

Date (mm/dd/yy): 1-Sep-21

Sample: HG Comp

SGS Laboratory: Lakefield (Canada)

Technician: OHTA

Purpose: To determine the Abrasion Index of the sample

Procedure: The equipment and procedure duplicate the Bond method for determining an abrasion index.

Feed: 1,600 grams minus 3/4 inch plus 1/2 inch fraction

Number of cycles of 15 minutes: 4 Cycles

Reading:	#1	#2	Average
Original paddle weight, grams:	94.5497	94.5493	94.5495
Final paddle weight, grams:	94.3007	94.3007	94.3007

Abrasion Index, Ai:**0.249**

Predicted Wear Rates:

		<u>lb/kwh</u>	<u>kg/kwh</u>
Wet rod mill, rods:	$0.35*(Ai-0.020)^{0.20}$	0.26	0.12
Wet rod mill, liners:	$0.035*(Ai-0.015)^{0.30}$	0.023	0.010
<i>Ball Mill (overflow and grate discharge types)</i>			
Wet ball mill, balls:	$0.35*(Ai-0.015)^{0.33}$	0.22	0.098
Wet ball mill, liners:	$0.026*(Ai-0.015)^{0.30}$	0.017	0.0076
<i>Ball Mill (grate discharge type)</i>			
Dry ball mill, balls:	$0.05*(Ai)^{0.5}$	0.025	0.011
Dry ball mill, liners:	$0.005*(Ai)^{0.5}$	0.0025	0.0011
<i>Crushers (gyratory, jaw, cone)</i>			
Crusher, liners:	$(Ai+0.22)/11$	0.043	0.019
Roll crusher, shells:	$(Ai/10)^{0.67}$	0.084	0.038

SGS Minerals Services

STANDARD BOND ABRASION TEST

Project No.: 18559-01
 Sample: HG Comp

Date: 1-Sep-21
 SGS Laboratory: Lakefield (Canada)

Product Particle Size Analysis

Mesh	Size	Weight grams	% Retained		% Passing
	µm		Individual	Cumulative	Cumulative
1/2 in	12,700	244.3	29.6	29.6	70.4
3/8 in	9,500	162.6	19.7	49.3	50.7
3	6,700	60.3	7.30	56.6	43.4
4	4,750	24.1	2.92	59.5	40.5
6	3,350	13.8	1.67	61.2	38.8
8	2,360	12.7	1.54	62.7	37.3
10	1,700	6.00	0.73	63.5	36.5
14	1,180	4.60	0.56	64.0	36.0
20	850	4.20	0.51	64.5	35.5
28	600	6.30	0.76	65.3	34.7
35	425	10.9	1.32	66.6	33.4
48	300	19.5	2.36	69.0	31.0
65	212	31.3	3.79	72.8	27.2
100	150	25.5	3.09	75.8	24.2
-100	-150	199.4	24.2	100.0	-
	Total	825.5	100.0	K80	14,706

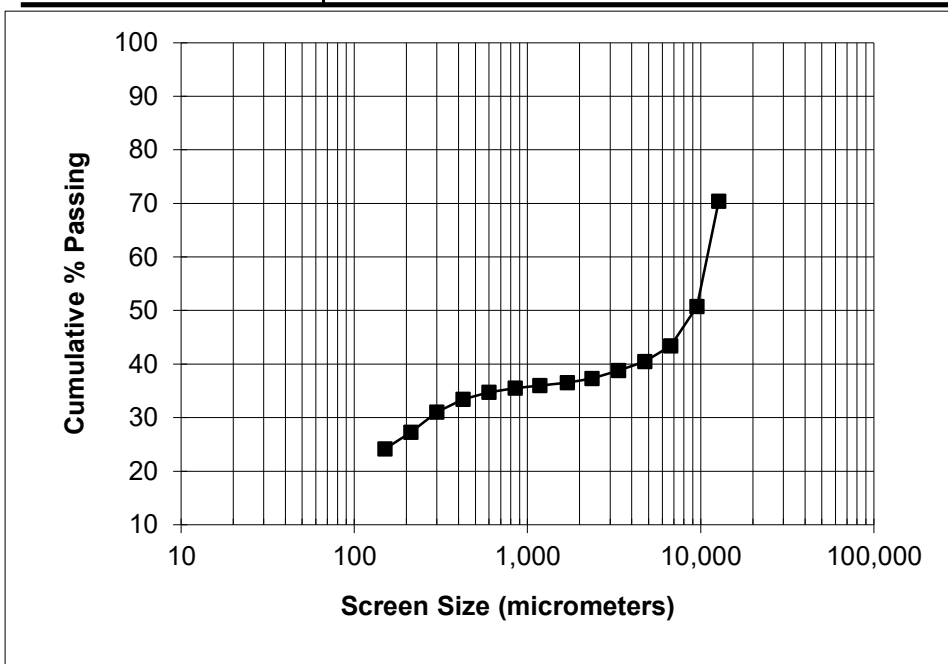

SGS Minerals Services

STANDARD BOND ABRASION TEST

Project No.: 18559-01

Date (mm/dd/yy): 1-Sep-21

Sample: LG Comp

SGS Laboratory: Lakefield (Canada)

Technician: OHTA

Purpose: To determine the Abrasion Index of the sample

Procedure: The equipment and procedure duplicate the Bond method for determining an abrasion index.

Feed: 1,600 grams minus 3/4 inch plus 1/2 inch fraction

Number of cycles of 15 minutes: 4 Cycles

Reading:	#1	#2	Average
Original paddle weight, grams:	94.5415	94.5416	94.5416
Final paddle weight, grams:	94.2074	94.2076	94.2075

Abrasion Index, Ai:**0.334**

Predicted Wear Rates:

		<u>lb/kwh</u>	<u>kg/kwh</u>
Wet rod mill, rods:	$0.35*(Ai-0.020)^{0.20}$	0.28	0.13
Wet rod mill, liners:	$0.035*(Ai-0.015)^{0.30}$	0.025	0.011
<i>Ball Mill (overflow and grate discharge types)</i>			
Wet ball mill, balls:	$0.35*(Ai-0.015)^{0.33}$	0.24	0.109
Wet ball mill, liners:	$0.026*(Ai-0.015)^{0.30}$	0.018	0.0084
<i>Ball Mill (grate discharge type)</i>			
Dry ball mill, balls:	$0.05*(Ai)^{0.5}$	0.029	0.013
Dry ball mill, liners:	$0.005*(Ai)^{0.5}$	0.0029	0.0013
<i>Crushers (gyratory, jaw, cone)</i>			
Crusher, liners:	$(Ai+0.22)/11$	0.050	0.023
Roll crusher, shells:	$(Ai/10)^{0.67}$	0.103	0.047

SGS Minerals Services

STANDARD BOND ABRASION TEST

Project No.: 18559-01
Sample: LG Comp

Date: 1-Sep-21
SGS Laboratory: Lakefield (Canada)

Product Particle Size Analysis

Mesh	Size	Weight grams	% Retained		% Passing
	µm		Individual	Cumulative	Cumulative
1/2 in	12,700	329.1	38.8	38.8	61.2
3/8 in	9,500	213.5	25.2	64.0	36.0
3	6,700	36.1	4.26	68.3	31.7
4	4,750	13.1	1.55	69.8	30.2
6	3,350	7.60	0.90	70.7	29.3
8	2,360	4.30	0.51	71.2	28.8
10	1,700	3.30	0.39	71.6	28.4
14	1,180	2.90	0.34	72.0	28.0
20	850	2.50	0.30	72.3	27.7
28	600	3.70	0.44	72.7	27.3
35	425	6.40	0.76	73.5	26.5
48	300	12.6	1.49	74.9	25.1
65	212	22.4	2.64	77.6	22.4
100	150	20.0	2.36	80.0	20.0
-100	-150	169.9	20.0	100.0	-
	Total	847.4	100.0	K80	15,825

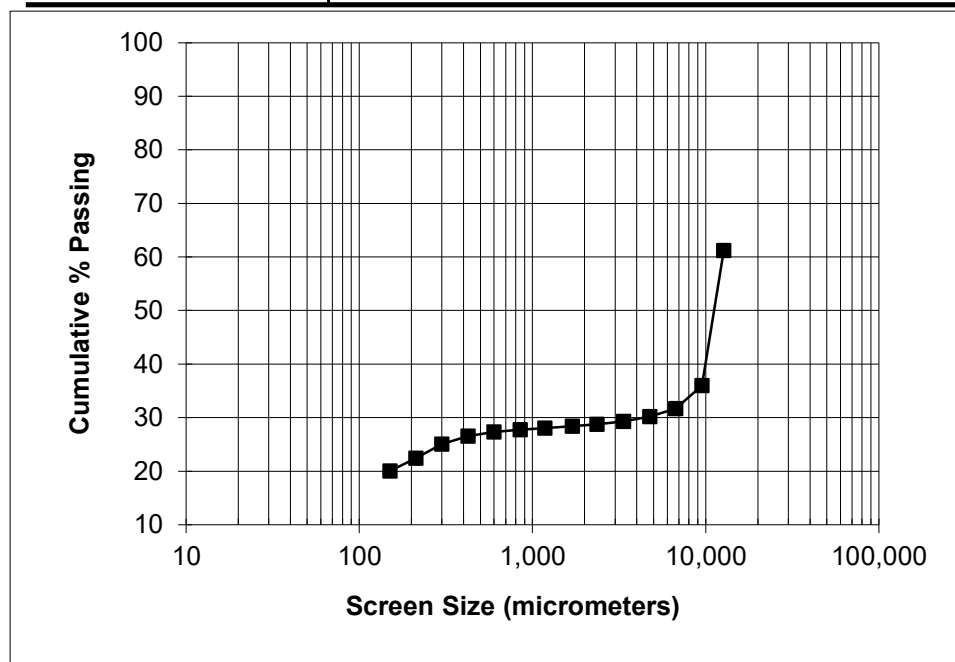

SMC TEST[®] REPORT

North American Nickel

Tested by: SGS Minerals Services

Ontario, Canada

Prepared by: Matt Weier

JKTech Job No: 21007/P33

Testing Date: August 2021



Contents

1	Executive Summary	5
1.1	SMC Results Summary	5
2	Introduction.....	7
3	The SMC Test®	8
3.1	Introduction.....	8
3.2	General Description and Test Background	8
3.3	The Test Procedure.....	9
3.3.1	Particle Selection Method.....	9
3.3.2	Cut Core Method	10
3.4	SMC Test® Results.....	11
4	References	17
5	Disclaimer.....	18

Appendices

APPENDIX A.	SAG Circuit Specific Energy (SCSE).....	20
APPENDIX B.	Background And Use Of The SMC Test®	24

List Of Figures

<i>Figure 1 - Frequency Distribution of A*b in the JKTech Database.....</i>	<i>6</i>
<i>Figure 2 - Frequency Distribution of SCSE in the JKTech Database</i>	<i>6</i>
<i>Figure 3 – Relationship between Particle Size and A*b.....</i>	<i>9</i>
<i>Figure 4 – A Typical Set of Particles for Breakage (Particle Selection Method).....</i>	<i>10</i>
<i>Figure 5 – Orientations of Pieces for Breakage (Cut Core Method)</i>	<i>11</i>
<i>Figure 6 – Cumulative Distribution of DWi Values in SMCT Database.....</i>	<i>14</i>
<i>Figure 7 - Cumulative Distribution of Mia, Mih and Mic Values in the SMCT Database.....</i>	<i>14</i>
<i>Figure 8 - Frequency Distribution of A*b in the JKTech Database.....</i>	<i>16</i>
<i>Figure 9 - Frequency Distribution of SCSE in the JKTech Database</i>	<i>16</i>

List Of Tables

<i>Table 1 - SMC Test[®] Results.....</i>	<i>5</i>
<i>Table 2 – Parameters derived from the SMC Test[®] Results.....</i>	<i>5</i>
<i>Table 3 - SMC Test[®] Results.....</i>	<i>12</i>
<i>Table 4 – Parameters derived from the SMC Test[®] Results.....</i>	<i>12</i>
<i>Table 5 – Crusher Simulation Model Specific Energy Matrix.....</i>	<i>13</i>
<i>Table 6 – Derived Values for A*b, ta and SCSE.....</i>	<i>15</i>

1 Executive Summary

1.1 SMC Results Summary

Table 1 - SMC Test® Results

Sample Designation	DWi (kWh/m ³)	DWi (%)	Mi Parameters (kWh/t)			SG
			Mia	Mih	Mic	
HG COMP	11.3	94.0	23.4	19.2	9.9	3.41
LG COMP	13.2	99.0	28.7	24.3	12.6	3.15
P COMP	6.0	41.0	15.3	11.1	5.7	3.13
S COMP	2.5	7.0	6.8	4.1	2.1	3.49
SN COMP	2.6	8.0	6.6	4.1	2.1	3.73

Table 2 – Parameters derived from the SMC Test® Results

Sample Designation	A	b	A*b	t _a	SCSE (kWh/t)
HG COMP	73.3	0.41	30.1	0.23	12.79
LG COMP	99.5	0.24	23.9	0.20	14.31
P COMP	68.1	0.77	52.4	0.43	9.45
S COMP	74.3	1.89	140.4	1.04	6.23
SN COMP	77.7	1.84	143.0	0.99	6.04

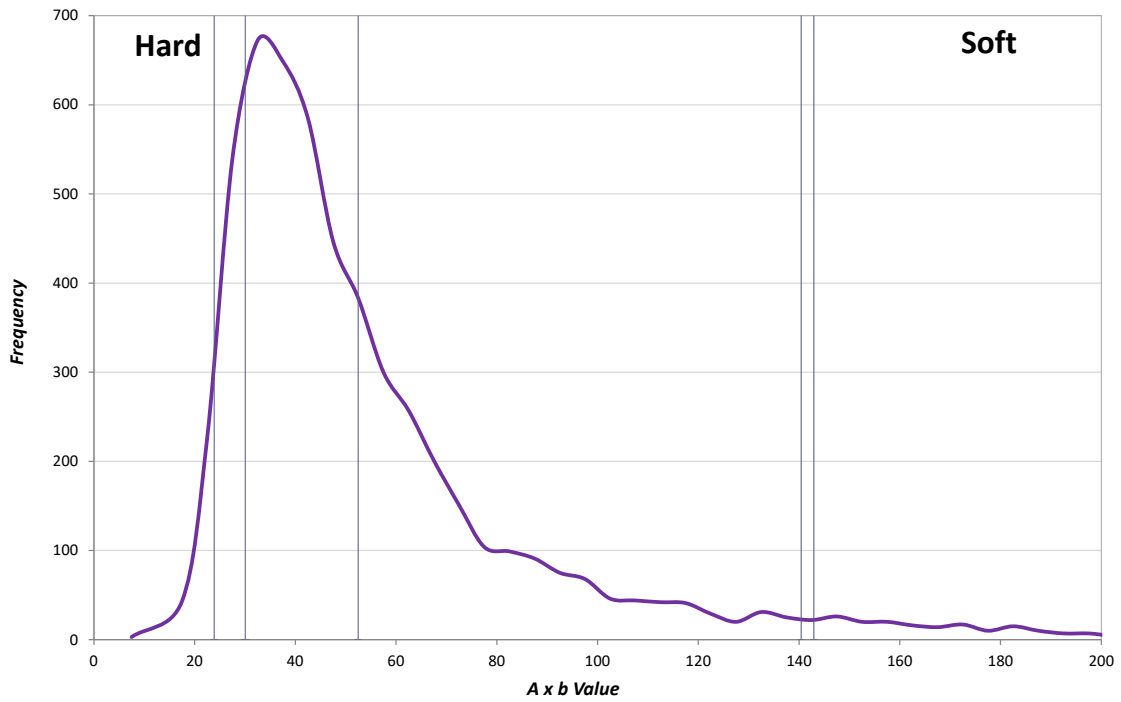

Figure 1 - Frequency Distribution of A*b in the JKTech Database

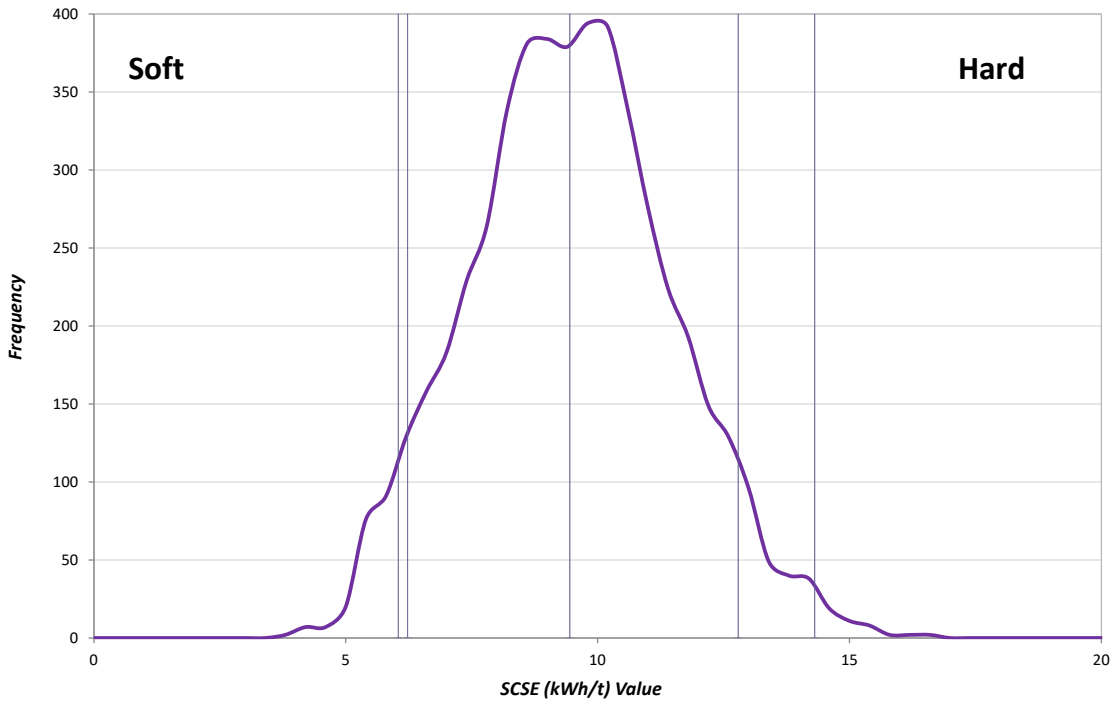

Figure 2 - Frequency Distribution of SCSE in the JKTech Database

2 Introduction

SMC data for five samples from Phikwe Selebi Project were received from SGS Minerals Services on August 31, 2021, by JKTech for SMC test analysis. The samples were identified as HG COMP, LG COMP, P COMP, S COMP and SN COMP. The data were analysed to determine the JKSimMet and SMC Test comminution parameters. SMC Test results were forwarded to SMC Testing Pty Ltd for the analysis of the SMC Test data. Analysis and reporting were completed on September 01, 2021.

Some samples in this report have been previously reported as JKTech job 21007/P27. They have been included at SGS Minerals Services request.

3 The SMC Test®

3.1 Introduction

The standard JK Drop-Weight test provides ore specific parameters for use in the JKSimMet Mineral Processing Simulator software. In JKSimMet, these parameters are combined with equipment details and operating conditions to analyse and/or predict SAG/autogenous mill performance. The same test procedure also provides ore type characterisation for the JKSimMet crusher model.

The SMC Test was developed by Steve Morrell of SMC Testing Pty Ltd (SMCT). The test provides a cost effective means of obtaining these parameters, in addition to a range of other power-based comminution parameters, from drill core or in situations where limited quantities of material are available. The ore specific parameters have been calculated from the test results and are supplied to North American Nickel in this report as part of the standard procedure

3.2 General Description and Test Background

The SMC Test® was originally designed for the breakage characterisation of drill core and it generates a relationship between input energy (kWh/t) and the percent of broken product passing a specified sieve size. The results are used to determine the so-called JK Drop-Weight index (DWi), which is a measure of the strength of the rock when broken under impact conditions and has the units kWh/m³. The DWi is directly related to the JK rock breakage parameters A and b and hence can be used to estimate the values of these parameters as well as being correlated with the JK abrasion parameter - t_a . For crusher modelling the t_{10} - E_{cs} matrix can also be derived. This is done by using the size-by-size $A*b$ values that are used in the SMC Test® data analysis (see below) to estimate the t_{10} - E_{cs} values for each of the relevant size fractions in the crusher model matrix.

For power-based calculations, (see APPENDIX B), the SMC Test® provides the comminution parameters M_{ia} , M_{ih} and M_{ic} . M_{ia} is the work index for the grinding of coarser particles (> 750 µm) in tumbling mills such as autogenous (AG), semi-autogenous (SAG), rod and ball mills. M_{ih} is the work index for the grinding in High Pressure Grinding Rolls (HPGR) and M_{ic} for size reduction in conventional crushers.

The SMC Test® is a precision test, which uses particles that are either cut from drill core using a diamond saw to achieve close size replication or else selected from crushed material so that particle mass variation is controlled within a prescribed range. The particles are then broken at a number of prescribed impact energies. The high degree of control imposed on both the size of particles and the breakage energies used, means that the test is largely free of the repeatability problems associated with tumbling-mill based tests. Such tests usually suffer from variations in feed size (which is not closely controlled) and energy input, often assumed to be constant when in reality it can be highly variable (Levin, 1989).

The relationship between the DWi and the JK rock breakage parameters makes use of the size-by-size nature of rock strength that is often apparent from the results of full JK Drop-Weight tests. The effect is illustrated in Figure 3, which plots the normalized values of $A*b$ against particle size. This figure also shows how the gradient of these plots varies across the full range of rock types tested. In the case of a conventional JK Drop-Weight test, these values are effectively averaged and a mean value of A and b is reported. The SMC Test® uses a single size and makes use of relationships such as that shown in Figure 3 to predict the A and b of the particle size that has the same value as the mean for a JK full Drop-Weight test.

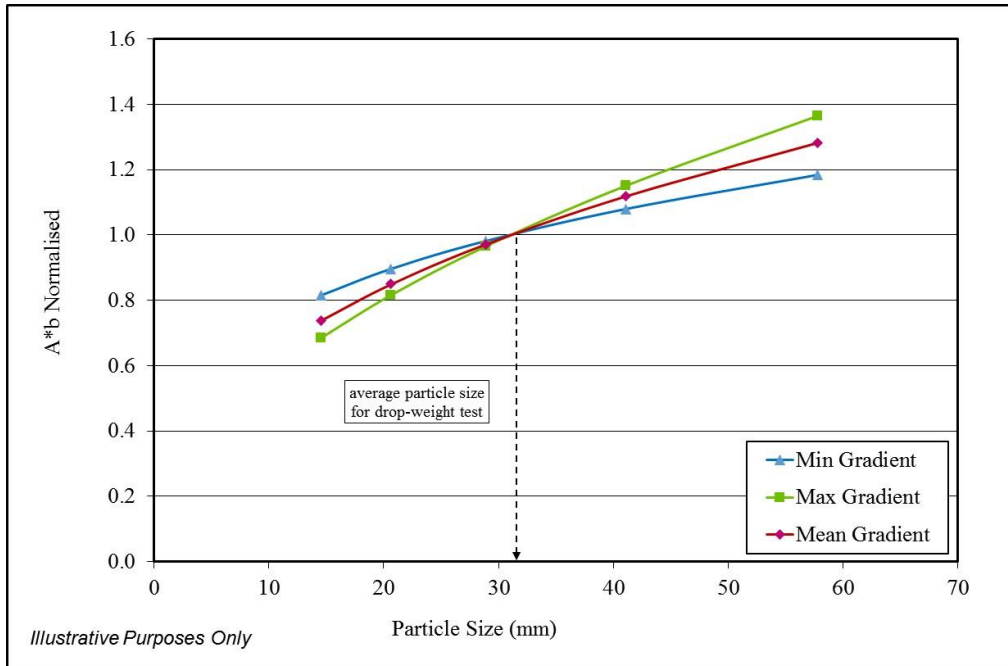

Figure 3 – Relationship between Particle Size and A*b

3.3 The Test Procedure

In the SMC Test®, five sets of 20 particles are broken, each set at a different specific energy level, using a JK Drop-Weight tester. The breakage products are screened at a sieve size selected to provide a direct measurement of the t_{10} value.

The test calls for a prescribed target average volume for the particles, with the target being chosen to be equivalent to the mean volume of particles in one of the standard JK Drop-Weight test size fractions.

The rest height of the drop-head (gap) is recorded after breakage of each particle to allow for a correction to the drop energy. After breaking all 20 particles in a set, the broken product is sieved at an aperture size, one tenth of the original particle size. Thus, the percent passing mass gives a direct reading of the t_{10} value for breakage at that energy level.

There are two alternative methods of preparing the particle sets for breakage testing: the particle selection method and the cut core method. The particle selection method is the most commonly used as it is generally less time consuming. The cut core method requires less material, so tends to be used as a fallback method, only when necessary to cope with restricted sample availability.

3.3.1 Particle Selection Method

For the particle selection method, the test is carried out on material in one of three alternative size fractions: -31.5+26.5, -22.4+19 or -16+13.2 mm. The largest size fraction is preferred but requires more material.

In the particle selection method, particles are chosen so that their individual masses lie within $\pm 30\%$ of the target mass and the mean mass for each set of 20 lies within $\pm 10\%$ of the target mass. A typical set of particles is shown in Figure 4.



Figure 4 – A Typical Set of Particles for Breakage (Particle Selection Method)

Before commencing breakage tests on the particles, the ore density is determined by first weighing a representative sample of particles in air and then in water.

3.3.2 Cut Core Method

The cut core method uses cut pieces of quartered (slivered) drill core. Whole core or half core can be used, but when received in this form it needs to be first quartered as a preliminary step in the procedure. Once quartered, any broken or tapered ends of the quartered lengths are cut, to square them off. Before the lengths of quartered core are cut to produce the pieces for testing, each one is weighed in air and then in water, to obtain a density measurement and a measure of its mass per unit length.

The size fraction targeted when the cut core method is used depends on the original core diameter. The target size fraction is selected to ensure that pieces of the correct volume will have “chunky” rather than “slabby” proportions.

Having measured the density of the core, the target volume can be translated into a target mass and with the average mass per unit length also known, an average cutting interval can be determined for the core.

Sufficient pieces of the quartered core are cut to generate 100 particles. These are then divided into the five sets of 20 and broken in the JK Drop-Weight tester at the five different energy levels. Within each set, the three possible orientations of the particles are equally represented (as far as possible, given that there are 20 particles). The orientations prescribed for testing are shown in Figure 5.



Figure 5 – Orientations of Pieces for Breakage (Cut Core Method)

The cut core method cannot be used for cores with diameters exceeding 70 mm, where the particle masses would be too large to achieve the highest prescribed energy level.

3.4 SMC Test[®] Results

The SMC Test[®] results for the HG COMP, LG COMP, P COMP, S COMP and SN COMP samples from Phikwe Selebi Project are given in Table 3. This table includes the average rock density and the DWi (Drop-Weight index) that is the direct result of the test procedure. The values determined for the M_{ia} , M_{in} and M_{ic} parameters developed by SMCT are also presented in this table. The M_{ia} parameter represents the coarse particle component (down to 750 μm), of the overall comminution energy and can be used together with the M_{ib} (fine particle component) to estimate the total energy requirements of a conventional comminution circuit. The use of these parameters is explained further in APPENDIX B. The derived estimates of parameters A , b and t_a that are required for JKSimMet comminution modelling are given in Table 4.

Also included in the derived results are the SAG Circuit Specific Energy (SCSE) values. The SCSE value is derived from simulations of a “standard” circuit comprising a SAG mill in closed circuit with a pebble crusher. This allows $A*b$ values to be described in a more meaningful form. SCSE is described in detail in APPENDIX A.

In the case of the HG COMP, LG COMP, P COMP, S COMP and SN COMP samples from Phikwe Selebi Project, the A and b estimates are based on a correlation using the database of all results so far accumulated by SMCT.

Table 3 - SMC Test[®] Results

Sample Designation	DWi (kWh/m ³)	DWi (%)	Mi Parameters (kWh/t)			SG
			Mia	Mih	Mic	
HG COMP	11.31	94	23.4	19.2	9.9	3.41
LG COMP	13.20	99	28.7	24.3	12.6	3.15
P COMP	5.98	41	15.3	11.1	5.7	3.13
S COMP	2.48	7	6.8	4.1	2.1	3.49
SN COMP	2.61	8	6.6	4.1	2.1	3.73

For more details on how the M_{ia} , M_{ih} and M_{ic} parameters are derived and used, see APPENDIX B or go to the SMC Testing website at <http://www.smctestng.com/about>.

Table 4 – Parameters derived from the SMC Test[®] Results

Sample Designation	A	b	t_a	SCSE (kWh/t)
HG COMP	73.3	0.41	0.23	12.79
LG COMP	99.5	0.24	0.20	14.31
P COMP	68.1	0.77	0.43	9.45
S COMP	74.3	1.89	1.04	6.23
SN COMP	77.7	1.84	0.99	6.04

The influence of particle size on the specific comminution energy needed to achieve a particular t_{10} value can also be inferred from the SMC Test[®] results. The energy requirements for five particle sizes, each crushed to three different t_{10} values, are presented in Table 5.

Table 5 – Crusher Simulation Model Specific Energy Matrix

Sample Designation	Particle Size (mm)														
	14.5			20.6			28.9			41.1			57.8		
	<i>t₁₀</i> Values (%) for Given Specific Energies in kWh/t														
	10	20	30	10	20	30	10	20	30	10	20	30	10	20	30
HG COMP	0.46	1.01	1.66	0.40	0.88	1.45	0.35	0.76	1.26	0.30	0.66	1.09	0.27	0.58	0.96
LG COMP	0.57	1.22	1.94	0.50	1.06	1.69	0.44	0.92	1.48	0.38	0.80	1.27	0.33	0.70	1.12
P COMP	0.27	0.59	0.98	0.23	0.51	0.85	0.20	0.45	0.75	0.18	0.39	0.64	0.15	0.34	0.57
S COMP	0.10	0.22	0.36	0.09	0.19	0.31	0.08	0.16	0.27	0.07	0.14	0.23	0.06	0.12	0.20
SN COMP	0.10	0.21	0.35	0.08	0.18	0.30	0.07	0.16	0.26	0.06	0.14	0.23	0.06	0.12	0.20

The SMC Test[®] database now contains over 40,000 test results on samples representing more than 1300 different deposits worldwide.

Around 99% of the DWi values lie in the range 0.5 to 14.0 kWh/m³, with soft ores being at the low end of this range and hard ores at the high end.

A cumulative graph of DWi values from the SMC Test[®] Database is shown in Figure 6 below. This graph can be used to compare the DWi of the material from Phikwe Selebi Project, with the entire population of ores in the SMCT database. The figures on the y-axis of the graph represent the percentages of all ores tested that are softer than the x-axis (DWi) value selected.

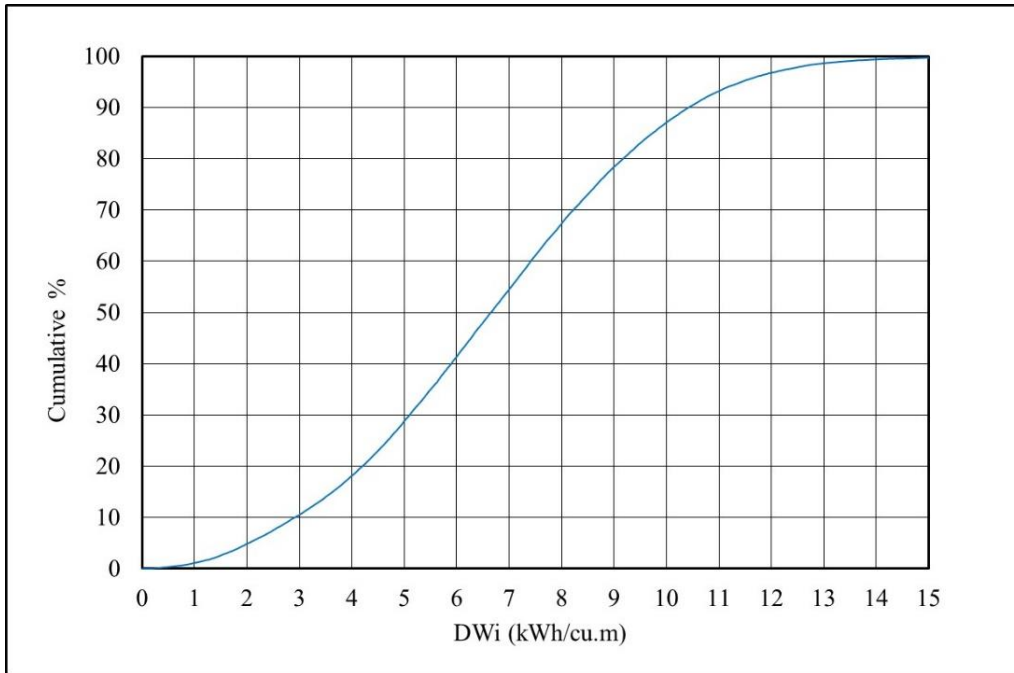

Figure 6 – Cumulative Distribution of DWi Values in SMCT Database

A further cumulative distribution graph is provided in Figure 7 to allow a comparison of the M_{ia} , M_{ih} and M_{ic} values obtained for the Phikwe Selebi Project material, with the entire population of values for these parameters contained in the SMCT database.

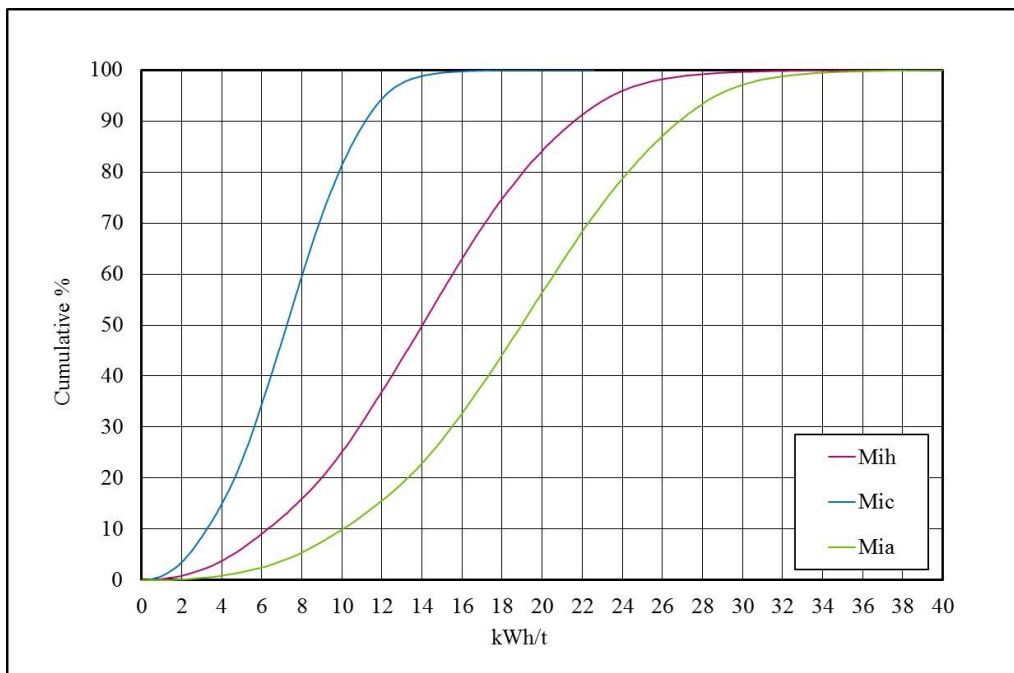

Figure 7 - Cumulative Distribution of Mia, Mih and Mic Values in the SMCT Database

The value of $A*b$, which is also a measure of resistance to impact breakage, is calculated and presented in Table 6, which also gives a comparison to the population of samples in the JKTech database, with the percent of samples present in the JKTech database that are softer. Note that in contrast to the DWi, a high value of $A*b$ means that an ore is soft whilst a low value means that it is hard.

Table 6 – Derived Values for A^*b , t_a and SCSE

Sample Designation	A^*b		t_a		SCSE (kWh/t)	
	Value	%	Value	%	Value	%
HG COMP	30.1	85.0	0.23	89.4	12.79	94.6
LG COMP	23.9	96.4	0.20	93.8	14.31	99.1
P COMP	52.4	39.1	0.43	51.8	9.45	50.1
S COMP	140.4	6.2	1.04	12.2	6.23	5.3
SN COMP	143.0	6.0	0.99	13.3	6.04	4.2

In Figure 8 and Figure 9 below, histogram style frequency distributions for the A^*b values and for the SCSE values in the JKTech JKDW database are shown respectively.

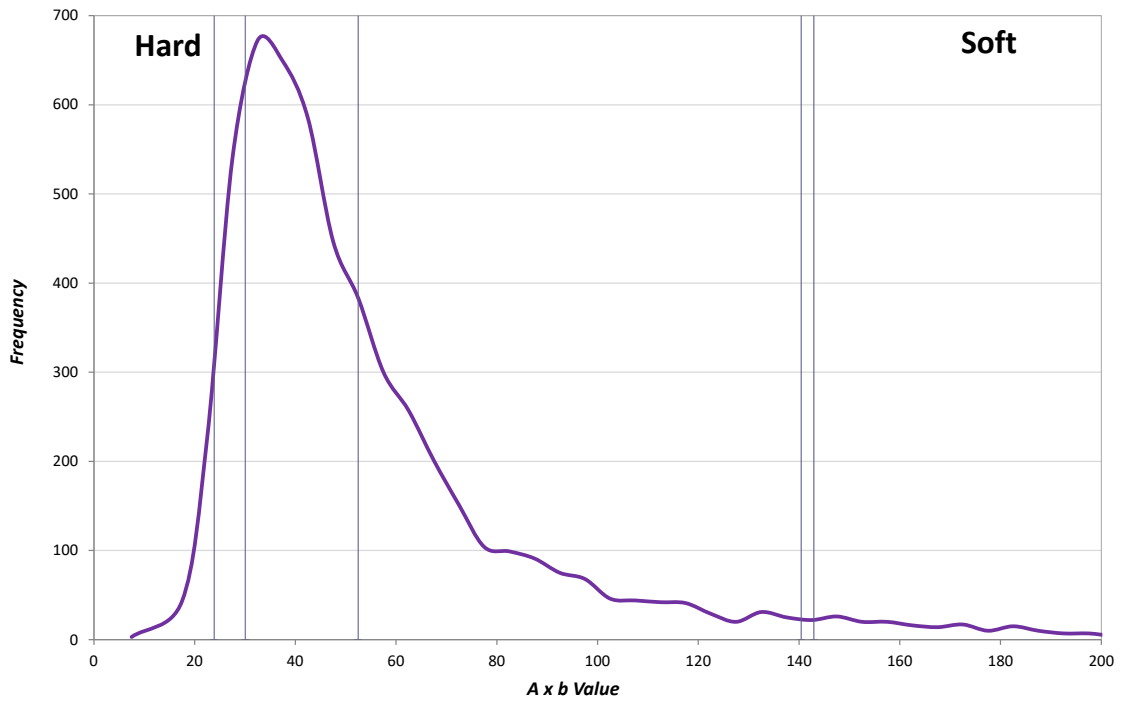

Figure 8 - Frequency Distribution of A*b in the JKTech Database

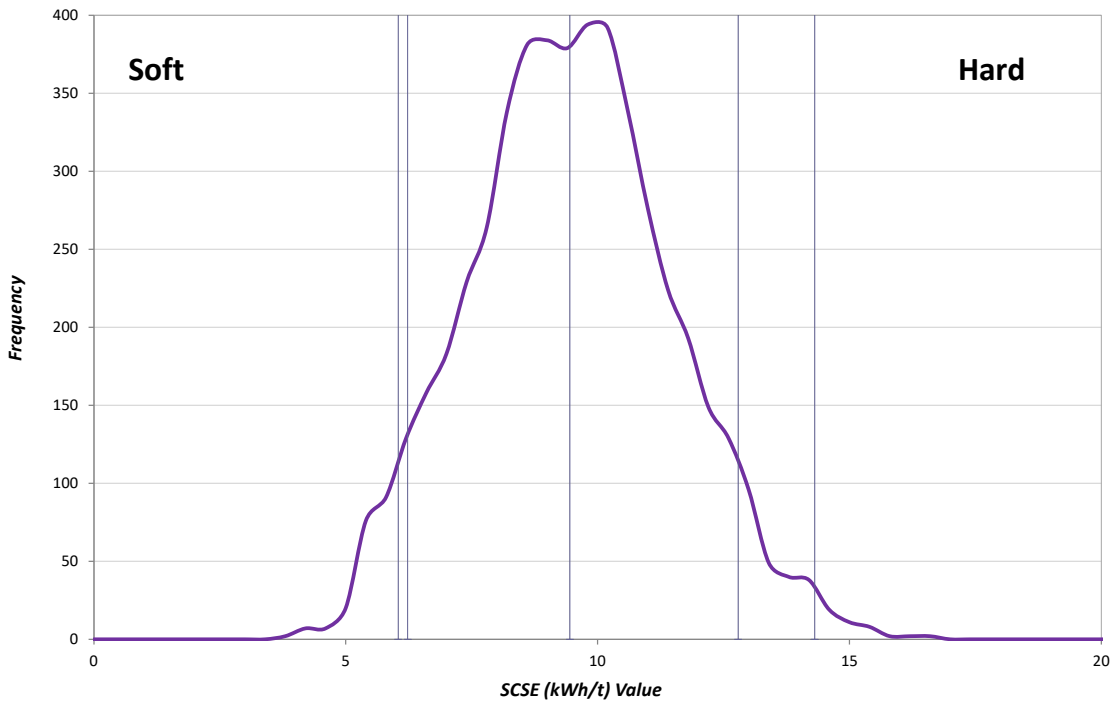

Figure 9 - Frequency Distribution of SCSE in the JKTech Database

4 References

- Andersen, J. and Napier-Munn, T.J., 1988, "Power Prediction for Cone Crushers", Third Mill Operators' Conference, Aus.I.M.M (Cobar, NSW), May 1988, pp 103 - 106
- Bailey, C., *et al*, 2009. "What Can Go Wrong in Comminution Circuit Design?", Proceedings of the Tenth Mill Operators' Conference, (Adelaide, SA), pp. 143–149
- Bond, F.C., 1961. "Crushing and Grinding Calculations Parts I and II", British *Chemical Engineering*, Vol 6, Nos 6 and 8
- Leung, K. 1987. "An Energy-Based Ore Specific Model for Autogenous and Semi-Autogenous Grinding Mills." Ph.D. Thesis. University of Queensland (unpublished)
- Leung, K., Morrison, R.D. and Whiten, W.J., 1987. "An Energy Based Ore Specific Model for Autogenous and Semi-autogenous Grinding", *Copper 87*, Vina del Mar, Vol. 2, pp 71 - 86
- Levin, J., 1989. Observation on the bond standard grindability test, and a proposal for a standard grindability test for fine materials. *SAIMM* 89 (1), 13-21.
- Morrell, S. 1996. "Power Draw of Wet Tumbling Mills and Its Relationship to Charge Dynamics - Parts I and II", *Transaction Inst. Min. Metall.* (Sect C: Mineral Process Extr. Metall.), 105, 1996, pp C43-C62
- Morrell, S., 2004^a. *Predicting the Specific Energy of Autogenous and Semi-autogenous Mills from Small Diameter Drill Core Samples*. *Minerals Engineering*, Vol 17/3 pp 447-451
- Morrell, S., 2004^b. *An Alternative Energy-Size Relationship To That Proposed By Bond For The Design and Optimisation Of Grinding Circuits*. *International Journal of Mineral Processing*, 74, 133-141.
- Morrell, S., 2006. *Rock Characterisation for High Pressure Grinding Rolls Circuit Design*, Proc International Autogenous and Semi Autogenous Grinding Technology, Vancouver, vol IV pp 267-278.
- Morrell, S., 2008, [A method for predicting the specific energy requirement of comminution circuits and assessing their energy utilisation efficiency](#), *Minerals Engineering*, Vol. 21, No. 3.
- Shi, F. and Kojovic, T., 2007. Validation of a model for impact breakage incorporating particle size effect. *Int. Journal of Mineral Processing*, 82, 156-163.
- Veillette, G., and Parker, B., 2005. Boddington Expansion Project Comminution Circuit Features and Testwork, Randol Gold Forum Proceedings.

5 Disclaimer

Warranty by JKTech

- a. JKTech will use its best endeavours to ensure that all documentation, data, recommendations, information, advice and reports ("Material"), provided by JKTech to the client ("Recipient"), is accurate at the time of providing it.

Extent of Warranty by JKTech

- b. JKTech does not make any representations as to any matter, fact or thing that is not expressly provided for in the Material.
- c. JKTech does not give any warranty, nor accept any liability in connection with the Material, except to the extent, if any, required by law or specifically provided in writing by JKTech to the Recipient.
- d. JKTech will not be liable to the Recipient for any claims relating to Material in any language other than in English.
- e. If, apart from this Disclaimer, any warranty would be implied whether by law, custom or otherwise, that warranty is to the full extent permitted by law excluded.
- f. The Recipient will promptly advise JKTech in writing of any losses, damages, compensation, liabilities, amounts, monetary and non-monetary costs and expenses ("Losses"), incurred or likely to be incurred by the Recipient or JKTech in connection with the Material, and any claims, actions, suits, demands or proceedings ("Liabilities") which the Recipient or JKTech may become liable in connection with the Material.

Indemnity and Release by the Recipient

- g. The Recipient indemnifies, releases, discharges and saves harmless, JKTech against any and all Losses and Liabilities, suffered or incurred by JKTech, whether under the law of contract, tort, statutory duty or otherwise as a result of:
- i) the Recipient relying on the Material;
 - ii) any liability for infringement of a third party's trade secrets, proprietary or confidential information, patents, registered designs, trademarks or names, copyright or other protected rights; and
 - iii) any act or omission of JKTech, any employee, agent or permitted sub-contractor of JKTech in connection with the Material.

Limit of Liability

- h. JKTech's liability to the Recipient in connection with the Material, whether under the law of contract, tort, statutory duty or otherwise, will be limited to the lesser of:
- i) the total cost of the job; or
 - ii) JKTech providing amended Material rectifying the defect.

Exclusion of Consequential Loss

- i. JKTech is not liable to the Recipient for any consequential, special or indirect loss (loss of revenue, loss of profits, business interruption, loss of opportunity and legal costs and disbursements), in connection with the Material whether under the law of contract, tort, statutory duty or otherwise.

Defects

- j. The Recipient must notify JKTech within seven days of becoming aware of a defect in the Material. To the extent that the defect is caused by JKTech's negligence or breach of contract, JKTech may, at its discretion, rectify the defect.

Duration of Liability

- k. After the expiration of one year from the date of first providing the Material to the client, JKTech will be discharged from all liability in connection with the Material. The Recipient (and persons claiming through or under the Recipient) will not be entitled to commence any action, claim or proceeding of any kind whatsoever after that date, against JKTech (or any employee of JKTech) in connection with the Material.

Contribution

- l. JKTech's liability to the Recipient for any loss or damage, whether under the law of contract, tort, statutory duty or otherwise will be reduced to the extent that an act or omission of the Recipient, its employees or agents, or a third party to whom the Recipient has disclosed the Material, contributed to the loss or damage.

Severability

- m. If any provision of this Disclaimer is illegal, void, invalid or unenforceable for any reason, all other provisions which are self-sustaining and capable of separate enforcement will, to the maximum extent permitted by law, be and continue to be valid and enforceable.

Appendices

APPENDIX A. SAG Circuit Specific Energy (SCSE)

For a little over 20 years, the results of JK Drop Weight tests and SMC tests have been reported in part as A, b and t_a parameters. A and b are parameters which describe the response of the ore under test to increasing levels of input energy in single impact breakage. A typical t₁₀ v E_{cs} curve resulting from a Drop Weight test is shown in App Figure 1.

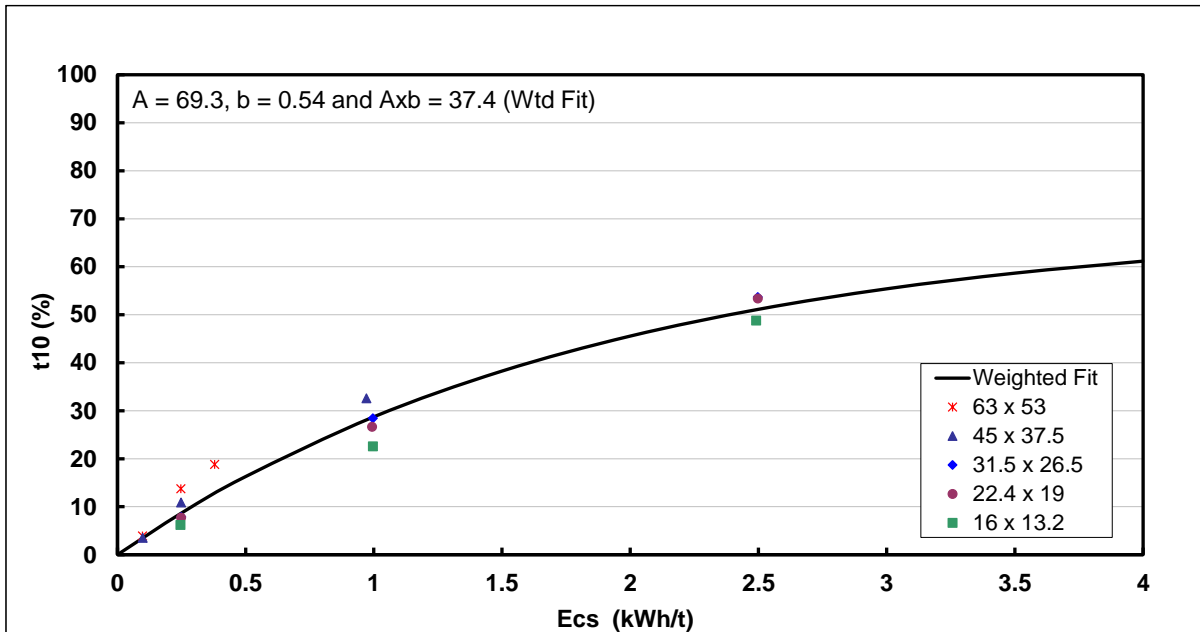

App Figure 1 – Typical t₁₀ v E_{cs} curve

The curve shown in App Figure 1 is represented by an equation which is given in Equation 1.

$$t_{10} = A(1 - e^{-b.Ecs}) \tag{Equation 1}$$

The parameters A and b are generated by least squares fitting Equation 1 to the JK Drop Weight test data. The parameter t_a is generated from a tumbling test.

Both A and b vary with ore type but having two parameters describing a single ore property makes comparison difficult. For that reason the product of A and b, referred to as A*b, which is related to the slope of the t₁₀ – E_{cs} curve at the origin, has been universally accepted as the parameter which represents an ore’s resistance to impact breakage.

The parameters A, b and t_a have no physical meaning in their own right. They are ore hardness parameters used by the AG/SAG mill model in JKSimMet which permits prediction of the product size distribution and the power draw of the AG/SAG mill for a given feed size distribution and feed rate. In a design situation, the dimensions of the mill are adjusted until the load in the mill reaches 25 % by volume when fed at the required feed rate. The model predicts the power draw under these conditions and from the power draw and throughput the specific energy is determined. The specific energy is mainly a function of the ore hardness (A and b values), the feed size and the dimensions of the mill (specifically the aspect ratio) as well as to a lesser extent the operating conditions such as ball load, mill speed, grate/pebble port size and pebble crusher activity.

There are two drawbacks to the approach of using A*b as the single parameter to describe the impact resistance of a particular ore. The first is that A*b is inversely related to impact resistance, which adds unnecessary complication. The second is that A*b is related to impact resistance in a non-linear manner. As mentioned earlier this relationship and how it affects comminution machine performance

can only be predicted via simulation modelling. Hence to give more meaning to the A and b values and to overcome these shortcomings, JKTech Pty Ltd and SMC Testing Pty Ltd have developed a “standard” simulation methodology to predict the specific energy required for a particular tested ore when treated in a “Standard” circuit comprising a SAG mill in closed circuit with a pebble crusher. The flowsheet is shown in App Figure 2 .

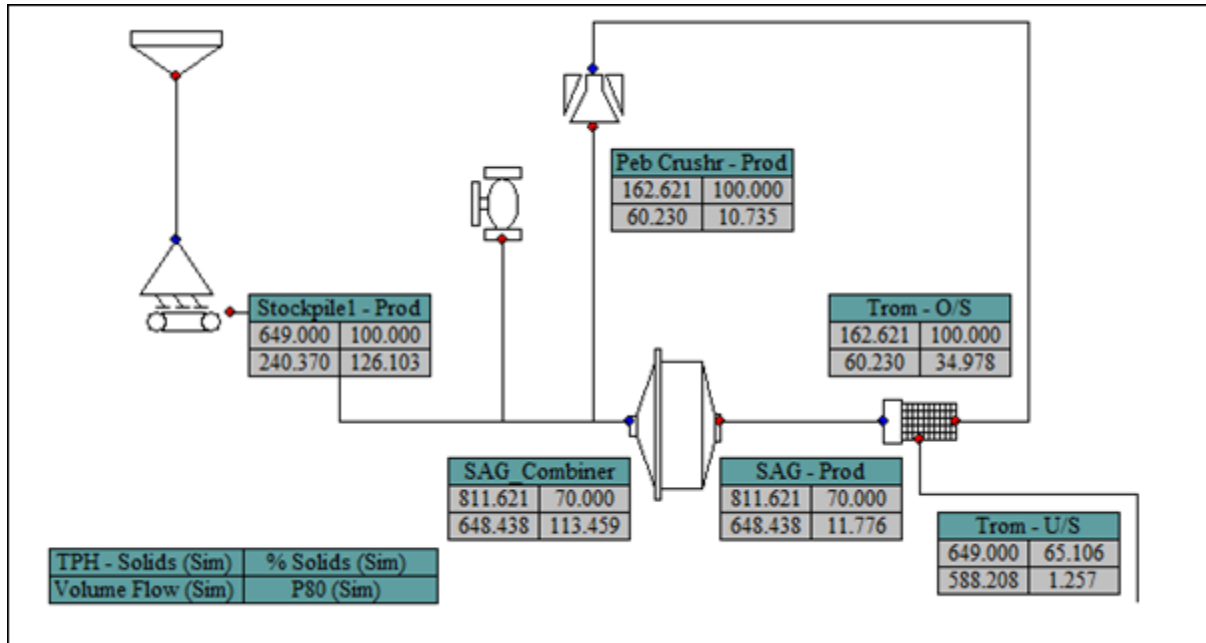

App Figure 2 – Flowsheet used for “Standard” AG/SAG circuit simulations

The specifications for the “standard” circuit are:

- SAG Mill
 - inside shell diameter to length ratio of 2:1 with 15 ° cone angles
 - ball charge of 15 %, 125 mm in diameter
 - total charge of 25 %
 - grate open area of 7 %
 - apertures in the grate are 100 % pebble ports with a nominal aperture of 56 mm
- Trommel
 - Cut Size of 12 mm
- Pebble Crusher
 - Closed Side Setting of 10 mm
- Feed Size Distribution
 - F_{80} from the t_a relationship given in Equation 2

The feed size distribution is taken from the JKTech library of typical feed size distributions and is adjusted to meet the ore specific 80 % passing size predicted using the Morrell and Morrison (1996) $F_{80} - t_a$ relationship for primary crushers with a closed side setting of 150 mm given in Equation 2.

$$F_{80} = 71.3 - 28.4 * \ln(t_a) \quad \text{Equation 2}$$

Simulations were conducted with $A*b$ values ranging from 15 to 400, t_a values ranging from 0.145 to 3.866 and solids SG values ranging from 2.1 to 4.5. For each simulation, the feed rate was adjusted until the total load volume in the SAG mill was 25 %. The predicted mill power draw and crusher power draw were combined and divided by the feed rate to provide the specific energy consumption. The results are shown in App Figure 3.

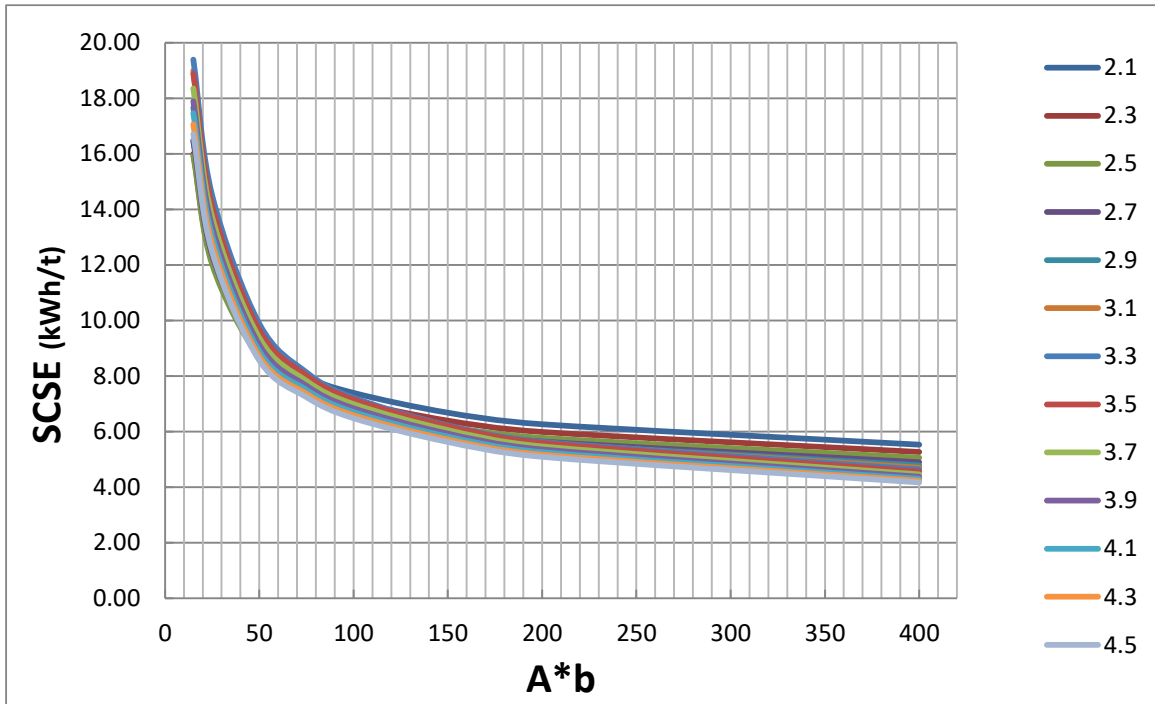

App Figure 3 – The relationship between A*b and specific energy at varying SG for the “Standard” circuit.

It is of note that the family of curves representing the relationship between Specific energy and A*b for the “standard” circuit is very similar to the specific energy – A*b relationship for operating mills published in Veillette and Parker, 2005 and reproduced here in App Figure 4.

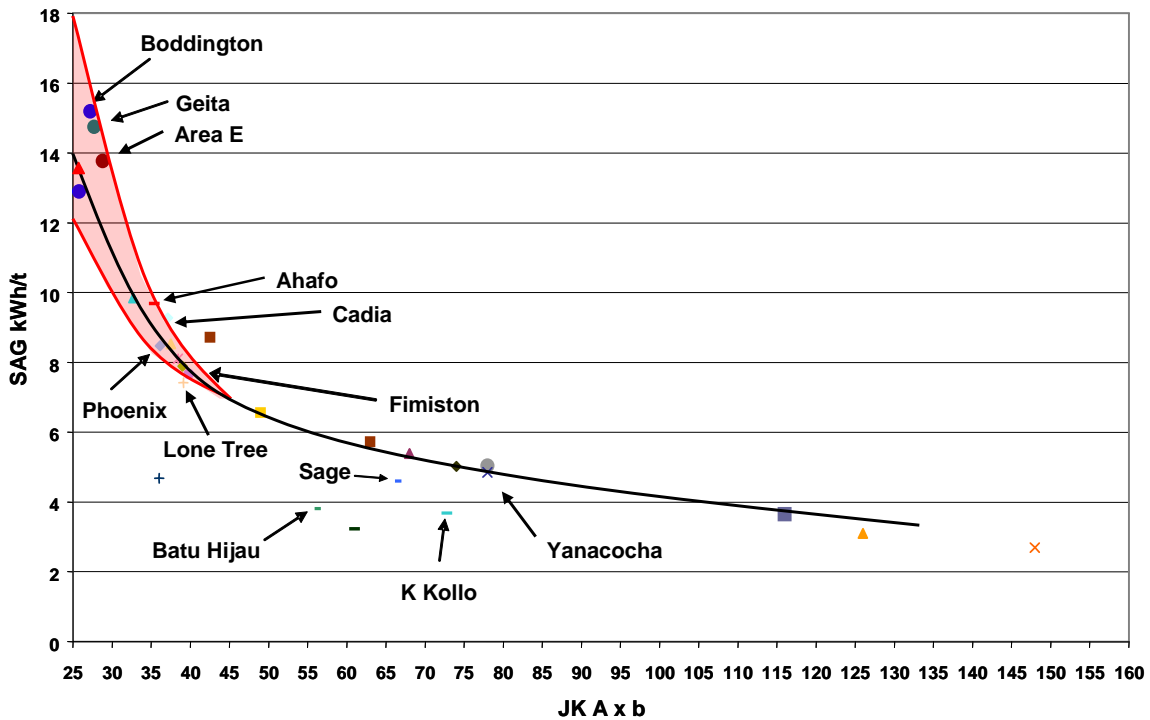

*App Figure 4 – A*b vs SAG kWh/t for operating AG/SAG mills (after Veillette and Parker, 2005).*

Of course, the SCSE quoted value will not necessarily match the specific energy required for an existing or a planned AG/SAG mill due to differences in the many operating and design variables such as feed size distribution, mill dimensions, ball load and size and grate, trommel and pebble crusher configuration. The SCSE is an effective tool to compare in a relative manner the expected behaviour of different ores in AG/SAG milling in exactly the same way as the Bond laboratory ball mill work index can be used to compare the relative grindability of different ores in ball milling (Bond, 1961 and Rowland and Kjos, 1980). However the originally reported A and b parameters which match the SCSE will be still be required in JKSimMet simulations of a proposed circuit to determine the AG/SAG mill specific energy required for that particular grinding task. Guidelines for the use of JKSimMet for such simulations were given in Bailey *et al*, 2009.

APPENDIX B. Background And Use Of The SMC Test®

B 1 Introduction

The SMC Test® was developed to provide a range of useful comminution parameters through highly controlled breakage of rock samples. Drill core, even quartered small diameter core is suitable. Only relatively small quantities of sample are required and can be re-used to conduct Bond ball work index tests.

The results from conducting the SMC Test® are used to determine the so-called drop-weight index (DW_i), which is a measure of the strength of the rock, as well as the comminution indices M_{ia} , M_{ih} and M_{ic} . The SMC Test® also estimates the JK rock breakage parameters A , b and t_a as well as the JK crusher model's t_{10} - E_{cs} matrix, all of which are generated as part of the standard report output from the test.

In conjunction with the Bond ball mill work index the DW_i and the M_i suite of parameters can be used to accurately predict the overall specific energy requirements of circuits containing:

- AG and SAG mills.
- Ball mills
- Rod mills
- Crushers
- High Pressure Grinding Rolls (HPGR)

The JK rock breakage parameters can be used to simulate crushing and grinding circuits using JKTech's simulator – JKSimMet.

B 2 Simulation Modelling and Impact Comminution Theory

When a rock fragment is broken, the degree of breakage can be characterised by the " t_{10} " parameter. The t_{10} value is the percentage of the original rock mass that passes a screen aperture one tenth of the original rock fragment size. This parameter allows the degree of breakage to be compared across different starting sizes.

The specific comminution energy (E_{cs}) has the units kWh/t and is the energy applied during impact breakage. As the impact energy is varied, so does the t_{10} value vary in response. Higher impact energies produce higher values of t_{10} , which of course means products with finer size distributions.

The equation describing the relationship between the t_{10} and E_{cs} is given below.

$$t_{10} = A(1 - e^{-b.E_{cs}}) \quad \text{Equation 1}$$

As can be seen from this equation, there are two rock breakage parameters A and b that relate the t_{10} (size distribution index) to the applied specific energy (E_{cs}). These parameters are ore specific and are normally determined from a full JK Drop-Weight test.

A typical plot of t_{10} vs E_{cs} from a JK Drop-Weight test is shown in App Figure 5. The relationship is characterised by the two-parameter equation above, where t_{10} is the dependent variable.

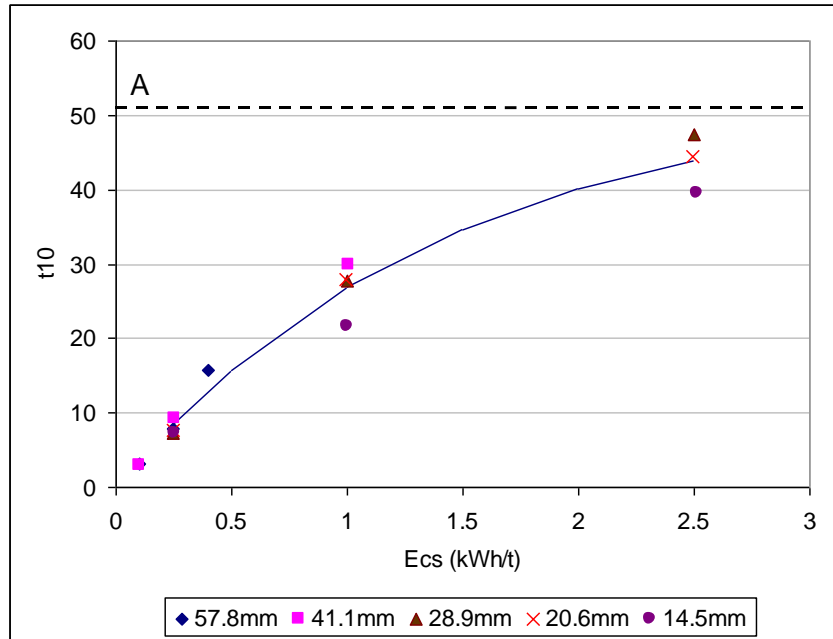

App Figure 5 - Typical t_{10} v Ecs Plot

The t_{10} can be thought of as a “fineness index” with larger values of t_{10} indicating a finer product size distribution. The value of parameter A is the limiting value of t_{10} . This limit indicates that at higher energies, little additional size reduction occurs as the Ecs is increased beyond a certain value. $A*b$ is the slope of the curve at ‘zero’ input energy and is generally regarded as an indication of the strength of the rock, lower values indicating a higher strength.

The SMC Test[®] is used to estimate the JK rock breakage parameters A and b by utilizing the fact that there is usually a pronounced (and ore specific) trend to decreasing rock strength with increasing particle size. This trend is illustrated in App Figure 6 which shows a plot of $A*b$ versus particle size for a number of different rock types.

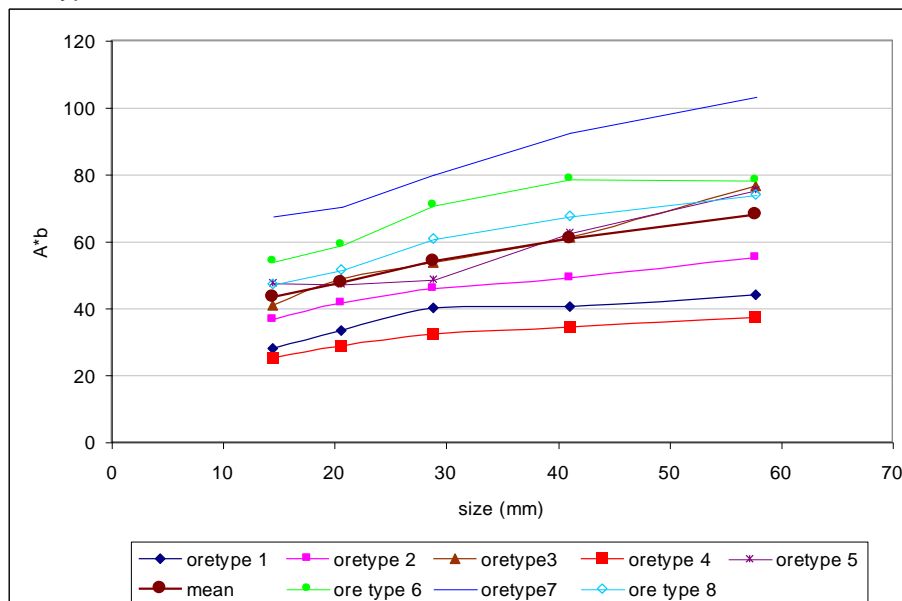

App Figure 6 - Size Dependence of $A*b$ for a Range of Ore Types

In the case of a conventional JK Drop-Weight test these values are effectively averaged and a mean value of A and b is reported. The SMC Test[®] uses a single size and makes use of relationships such as that shown in App Figure 6 to predict the A and b of the particle size that has the same value as the mean for a full JK Drop-Weight test.

An example of this is illustrated in App Figure 7, where the observed values of the product $A*b$ are plotted against those predicted using the DWi. Each of the data points in App Figure 7 is a result from a different ore type within an orebody.

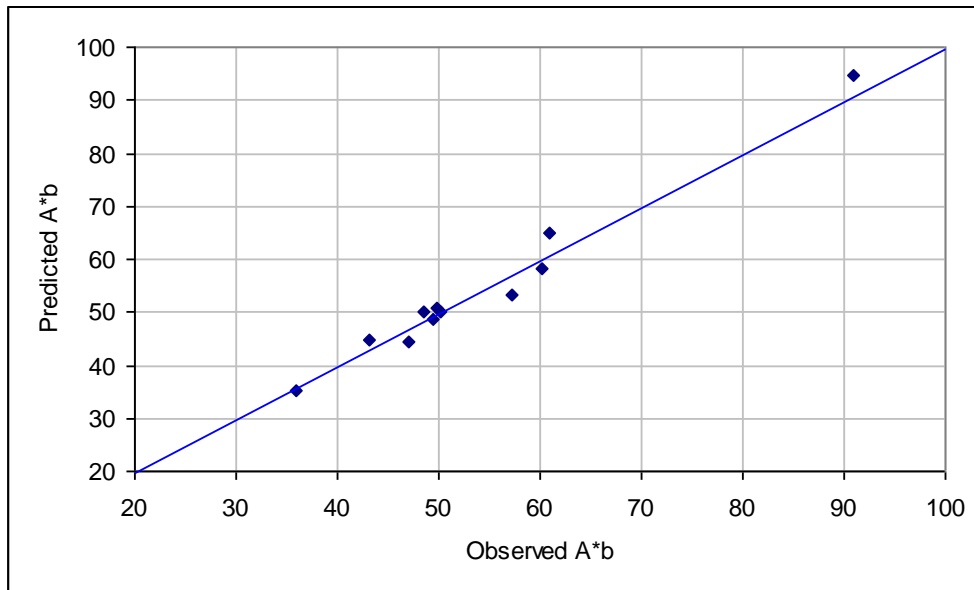

App Figure 7 - Predicted v Observed $A*b$

The A and b parameters are used with Equation 1 and relationships such as illustrated in App Figure 6 to generate a matrix of Ecs values for a specific range of t_{10} values and particle sizes. This matrix is used in crusher modelling to predict the power requirement of the crusher given a feed and a product size specification (Napier-Munn et al (1996)).

The A and b parameters are also used in AG/SAG mill models, such as those in JKSimMet, for predicting how the rock will break inside the mill. From this description the models can predict what the throughput, power draw and product size distribution will be (Napier-Munn et al (1996)). Modelling also enables a detailed flowsheet to be built up of the comminution circuit response to changes in ore type. It also allows optimisation strategies to be developed to overcome any deleterious changes in circuit performance predicted from differences in ore type. These strategies can include both changes to how mills are operated (eg ball load, speed etc) and changes to feed size distribution through modification of blasting practices and primary crusher operation (mine-to-mill).

B 3 Power-Based Equations

B 3.1 General

The DW_i , M_{ia} , M_{in} and M_{ic} parameters are used in so-called power-based equations which predict the specific energy of the associated comminution machines. The approach divides comminution equipment into three categories:

- Tumbling mills, eg AG, SAG, rod and ball mills
- Conventional reciprocating crushers, eg jaw, gyratory and cone
- HPGRs

Tumbling mills are described using 2 indices: M_{ia} and M_{ib}

Crushers have one index: M_{ic}

HPGRs have one index: M_{ih}

For tumbling mills the 2 indices relate to "coarse" and "fine" ore properties plus an efficiency factor which represents the influence of a pebble crusher in AG/SAG mill circuits. "Coarse" in this case is defined as spanning the size range from a P80 of 750 microns up to the P80 of the product of the last stage of crushing or HPGR size reduction prior to grinding. "Fine" covers the size range from a P80 of 750 microns down to P80 sizes typically reached by conventional ball milling, ie about 45 microns. The choice of 750 microns as the division between "coarse" and "fine" particle sizes was determined during the development of the technique and was found to give the best overall results across the range of plants in SMCT's data base. Implicit in the approach is that distributions are parallel and linear in log-log space.

The work index covering grinding in tumbling mills of coarse sizes is labelled M_{ia} . The work index covering grinding of fine particles is labelled M_{ib} (Morrell, 2008). M_{ia} values are provided as a standard output from a SMC Test[®] (Morrell, 2004a) whilst M_{ib} values can be determined using the data generated by a conventional Bond ball mill work index test (M_{ib} is NOT the Bond ball work index). M_{ic} and M_{ih} values are also provided as a standard output from a SMC Test[®] (Morrell, 2009).

The general size reduction equation is as follows (Morrell, 2004b):

$$W_i = M_i \cdot 4(x_2^{f(x_2)} - x_1^{f(x_1)}) \quad \text{Equation 3}$$

where

M_i = Work index related to the breakage property of an ore (kWh/tonne); for grinding from the product of the final stage of crushing to a P80 of 750 microns (coarse particles) the index is labelled M_{ia} and for size reduction from 750 microns to the final product P80 normally reached by conventional ball mills (fine particles) it is labelled M_{ib} . For conventional crushing M_{ic} is used and for HPGRs M_{ih} is used.

W_i = Specific comminution (kWh/tonne)

x_2 = 80% passing size for the product (microns)

x_1 = 80% passing size for the feed (microns)

$$f(x_j) = -(0.295 + x_j/1000000) \quad (\text{Morrell, 2006}) \quad \text{Equation 4}$$

For tumbling mills the specific comminution energy (W_i) relates to the power at the pinion or for gearless drives - the motor output. For HPGRs it is the energy inputted to the rolls, whilst for conventional crushers W_i relates to the specific energy as determined using the motor input power less the no-load power.

B 3.2 Specific Energy Determination for Comminution Circuits

The total specific energy (W_T) to reduce primary crusher product to final product size is given by:

$$W_T = W_a + W_b + W_c + W_h + W_s \quad \text{Equation 5}$$

where

W_a = specific energy to grind coarser particles in tumbling mills

W_b = specific energy to grind finer particles in tumbling mills

W_c = specific energy for conventional crushing

W_h = specific energy for HPGRs
 W_s = specific energy correction for size distribution

Clearly only the W values associated with the relevant equipment in the circuit being studied are included in Equation 5.

B 3.2.1 Tumbling mills

For coarse particle grinding in tumbling mills Equation 3 is written as:

$$W_a = K_1 M_{ia} \cdot 4(x_2^{f(x_2)} - x_1^{f(x_1)}) \quad \text{Equation 6}$$

where

K_1 = 1.0 for all circuits that do not contain a recycle pebble crusher and 0.95 where circuits do have a pebble crusher
 x_1 = P₈₀ in microns of the product of the last stage of crushing before grinding
 x_2 = 750 microns
 M_{ia} = Coarse ore work index and is provided directly by SMC Test®

For fine particle grinding Equation 3 is written as:

$$W_b = M_{ib} \cdot 4(x_3^{f(x_3)} - x_2^{f(x_2)}) \quad \text{Equation 7}$$

where

x_2 = 750 microns
 x_3 = P₈₀ of final grind in microns
 M_{ib} = Provided by data from the standard Bond ball work index test using the following equation (Morrell, 2006):

$$M_{ib} = 18.18 / P_1^{0.295} (Gbp) (p_{80}^{f(p_{80})} - f_{80}^{f(f_{80})}) \quad \text{Equation 8}$$

where

M_{ib} = fine ore work index (kWh/tonne)
 P_1 = closing screen size in microns
 Gbp = net grams of screen undersize per mill revolution
 p_{80} = 80% passing size of the product in microns
 f_{80} = 80% passing size of the feed in microns

Note that the Bond ball work index test should be carried out with a closing screen size which gives a final product P80 similar to that intended for the full scale circuit.

B 3.2.2 Conventional Crushers and HPGR

Equation 3 for conventional crushers is written as:

$$W_c = S_c K_2 M_{ic} \cdot 4(x_2^{f(x_2)} - x_1^{f(x_1)}) \quad \text{Equation 9}$$

where

S_c = coarse ore hardness parameter which is used in primary and secondary crushing situations. It is defined by Equation 10 with K_s set to 55.
 K_2 = 1.0 for all crushers operating in closed circuit with a classifying screen. If the crusher is in open circuit, eg pebble crusher in a AG/SAG circuit, K_2 takes the value of 1.19.
 x_1 = P₈₀ in microns of the circuit feed
 x_2 = P₈₀ in microns of the circuit product

M_{ic} = Crushing ore work index and is provided directly by SMC Test®

The coarse ore hardness parameter (S) makes allowance for the decrease in ore hardness that becomes significant in relatively coarse crushing applications such as primary and secondary cone/gyratory circuits. In tertiary and pebble crushing circuits it is normally not necessary and takes the value of unity. In full scale HPGR circuits where feed sizes tend to be higher than used in laboratory and pilot scale machines the parameter has also been found to improve predictive accuracy. The parameter is defined by Equation 10.

$$S = K_s(x_1, x_2)^{-0.2} \quad \text{Equation 10}$$

where

K_s = machine-specific constant that takes the value of 55 for conventional crushers and 35 in the case of HPGRs

x_1 = P₈₀ in microns of the circuit feed

x_2 = P₈₀ in microns of the circuit product

Equation 3 for HPGR's crushers is written as:

$$W_h = S_h K_3 M_{ih} .4(x_2^{f(x_2)} - x_1^{f(x_1)}) \quad \text{Equation 11}$$

where

S_h = coarse ore harness parameter as defined by Equation 10 and with K_s set to 35

K_3 = 1.0 for all HPGRs operating in closed circuit with a classifying screen. If the HPGR is in open circuit, K_3 takes the value of 1.19.

x_1 = P₈₀ in microns of the circuit feed

x_2 = P₈₀ in microns of the circuit product

M_{ih} = HPGR ore work index and is provided directly by SMC Test®

B 3.2.3 Specific Energy Correction for Size Distribution (Ws)

Implicit in the approach described in this appendix is that the feed and product size distributions are parallel and linear in log-log space. Where they are not, allowances (corrections) need to be made. By and large, such corrections are most likely to be necessary (or are large enough to be warranted) when evaluating circuits in which closed circuit secondary/tertiary crushing is followed by ball milling. This is because such crushing circuits tend to produce a product size distribution which is relatively steep when compared to the ball mill circuit cyclone overflow. This is illustrated in App Figure 8, which shows measured distributions from an open and closed crusher circuit as well as a ball mill cyclone overflow. The closed circuit crusher distribution can be seen to be relatively steep compared with the open circuit crusher distribution and ball mill cyclone overflow. Also the open circuit distribution more closely follows the gradient of the cyclone overflow. If a ball mill circuit were to be fed two distributions, each with same P80 but with the open and closed circuit gradients in App Figure 8, the closed circuit distribution would require more energy to grind to the final P80. How much more energy is required is difficult to determine. However, for the purposes of this approach it has been assumed that the additional specific energy for ball milling is the same as the difference in specific energy between open and closed crushing to reach the nominated ball mill feed size. This assumes that a crusher would provide this energy. However, in this situation the ball mill has to supply this energy and it has a different (higher) work index than the crusher (ie the ball mill is less energy efficient than a crusher and has to input more energy to do the same amount of size reduction). Hence from Equation 9, to crush to the ball mill circuit feed size (x_2) in open circuit requires specific energy equivalent to:

$$W_c = 1.19 * M_{ic} .4(x_2^{f(x_2)} - x_1^{f(x_1)}) \quad \text{Equation 12}$$

For closed circuit crushing the specific energy is:

$$W_c = 1 * M_{ic} \cdot 4(x_2^{f(x_2)} - x_1^{f(x_1)}) \tag{Equation 13}$$

The difference between the two (Equation 12 and Equation 13) has to be provided by the milling circuit with an allowance for the fact that the ball mill, with its lower energy efficiency, has to provide it and not the crusher. This is what is referred to in Equation 5 as W_s and for the above example is therefore represented by:

$$W_s = 0.19 * M_{ia} \cdot 4(x_2^{f(x_2)} - x_1^{f(x_1)}) \tag{Equation 14}$$

Note that in Equation 14 M_{ic} has been replaced with M_{ia} , the coarse particle tumbling mill grinding work index.

In AG/SAG based circuits the need for W_s appears to be unnecessary as App Figure 9 illustrates. Primary crusher feeds often have the shape shown in App Figure 9 and this has a very similar gradient to typical ball mill cyclone overflows. A similar situation appears to apply with HPGR product size distributions, as illustrated in App Figure 10. Interestingly SMCT's data show that for HPGRs, closed circuit operation appears to require a lower specific energy to reach the same P80 as in open circuit, even though the distributions for open and closed circuit look to have almost identical gradients. Closer examination of the distributions in fact shows that in closed circuit the final product tends to have slightly less very fine material, which may account for the different energy requirements between the two modes of operation. It is also possible that recycled material in closed circuit is inherently weaker than new feed, as it has already passed through the HPGR previously and may have sustained micro-cracking. A reduction in the Bond ball mill work index as measured by testing HPGR products compared it to the Bond ball mill work index of HPGR feed has been noticed in many cases in the laboratory (see next section) and hence there is no reason to expect the same phenomenon would not affect the recycled HPGR screen oversize.

It follows from the above arguments that in HPGR circuits, which are typically fed with material from closed circuit secondary crushers, a similar feed size distribution correction should also be applied. However, as the secondary crushing circuit uses such a relatively small amount of energy compared to the rest of the circuit (as it crushes to a relatively coarse size) the magnitude of size distribution correction is very small indeed – much smaller than the error associated with the technique - and hence may be omitted in calculations.

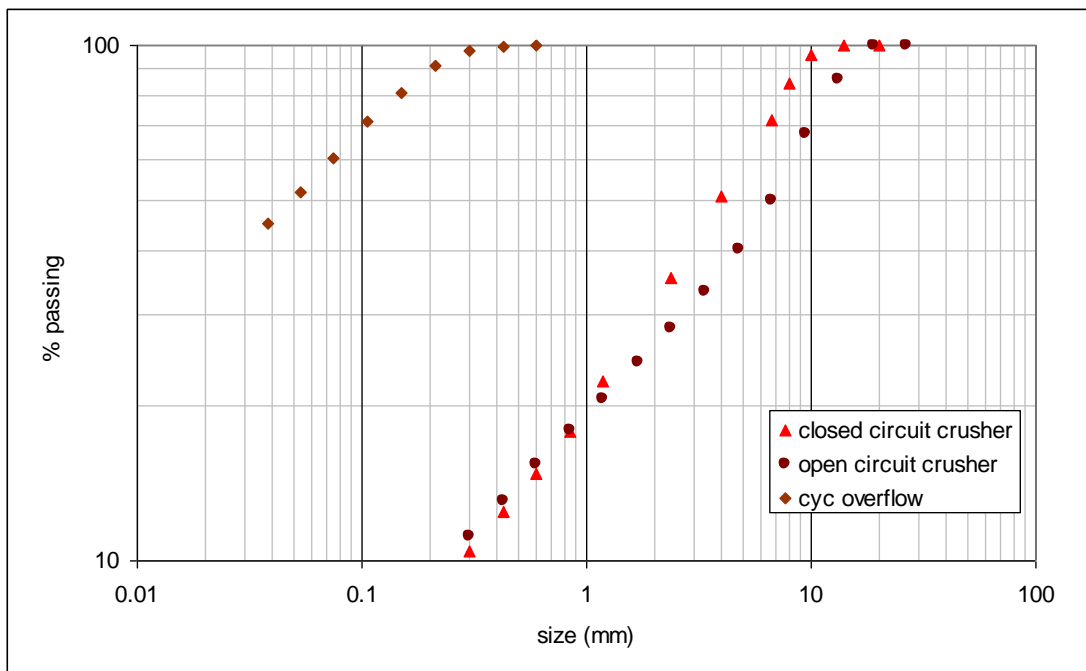

App Figure 8 – Examples of Open and Closed Circuit Crushing Distributions Compared with a Typical Ball Mill Cyclone Overflow Distribution

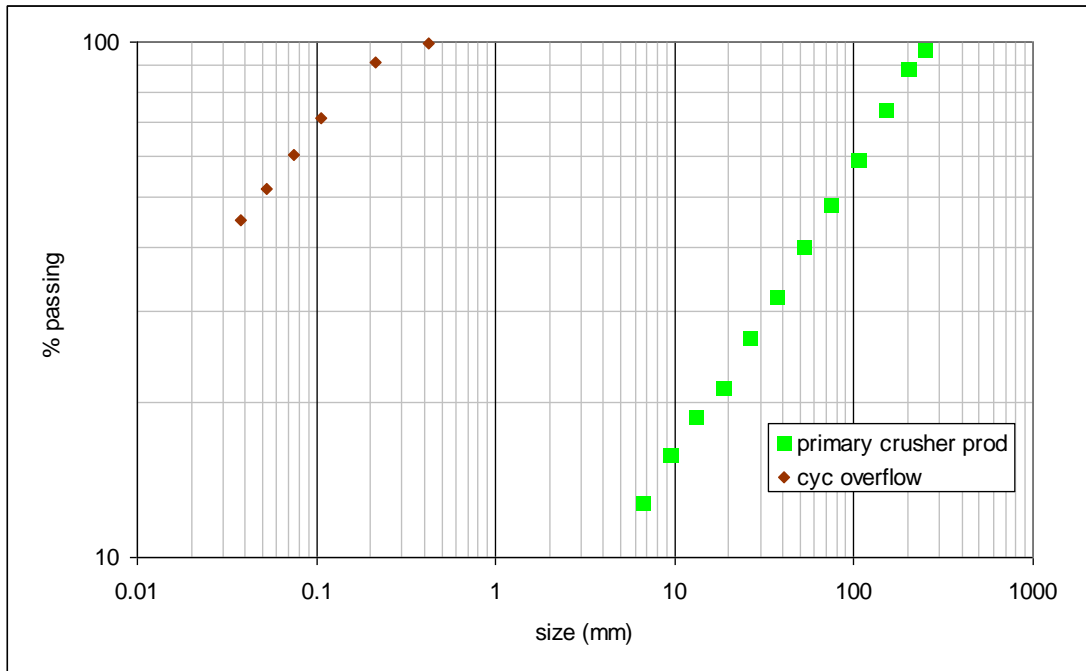

App Figure 9 – Example of a Typical Primary Crusher (Open and Circuit) Product Distribution Compared with a Typical Ball Mill Cyclone Overflow Distribution

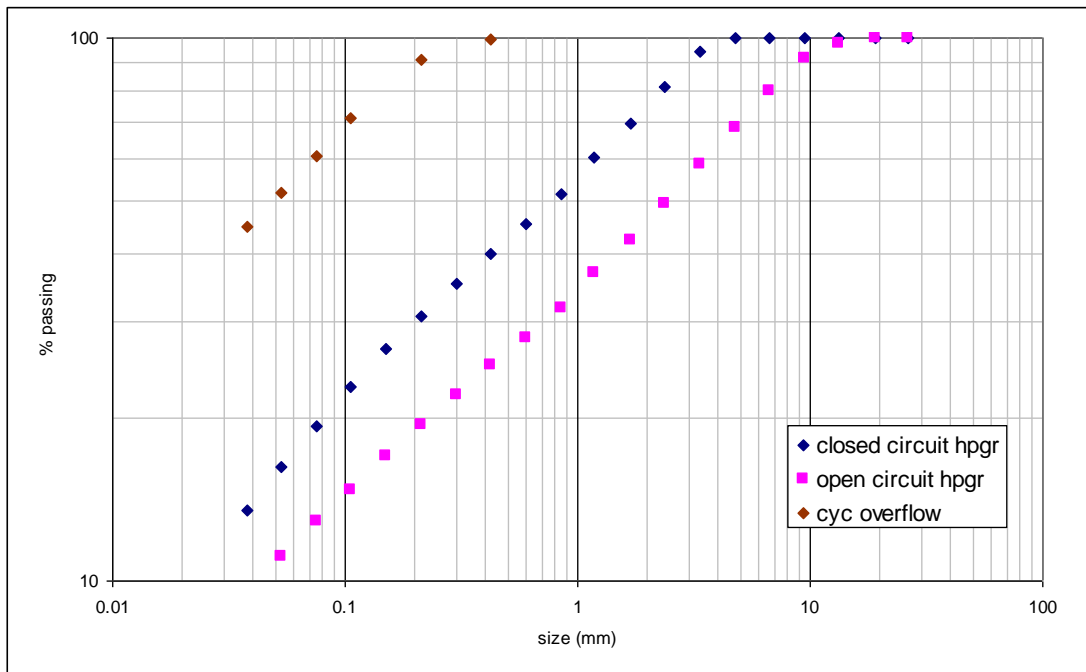

App Figure 10 – Examples of Open and Closed Circuit HPGR Distributions Compared with a Typical Ball Mill Cyclone Overflow Distribution

B 3.2.4 Weakening of HPGR Products

As mentioned in the previous section, laboratory experiments have been reported by various researchers in which the Bond ball work index of HPGR products is less than that of the feed. The amount of this reduction appears to vary with both material type and the pressing force used. Observed reductions in the Bond ball work index have typically been in the range 0-10%. In the approach described in this appendix no allowance has been made for such weakening. However, if HPGR products are available which can be used to conduct Bond ball work index tests on then M_{ib} values obtained from such tests can be used in Equation 7. Alternatively the M_{ib} values from Bond ball mill work index tests on HPGR feed material can be reduced by an amount that the user thinks is appropriate. Until more data become available from full scale HPGR/ball mill circuits it is suggested that, in the absence of Bond ball mill work index data on HPGR products, the M_{ib} results from HPGR feed material are reduced by no more than 5% to allow for the effects of micro-cracking.

B 3.3 Validation

B 3.3.1 Tumbling Mill Circuits

The approach described in the previous section was applied to over 120 industrial data sets. The results are shown in App Figure 11. In all cases, the specific energy relates to the tumbling mills contributing to size reduction from the product of the final stage of crushing to the final grind. Data are presented in terms of equivalent specific energy at the pinion. In determining what these values were on each of the plants in the data base it was assumed that power at the pinion was 93.5% of the measured gross (motor input) power, this figure being typical of what is normally accepted as being reasonable to represent losses across the motor and gearbox. For gearless drives (so-called wrap-around motors) a figure of 97% was used.

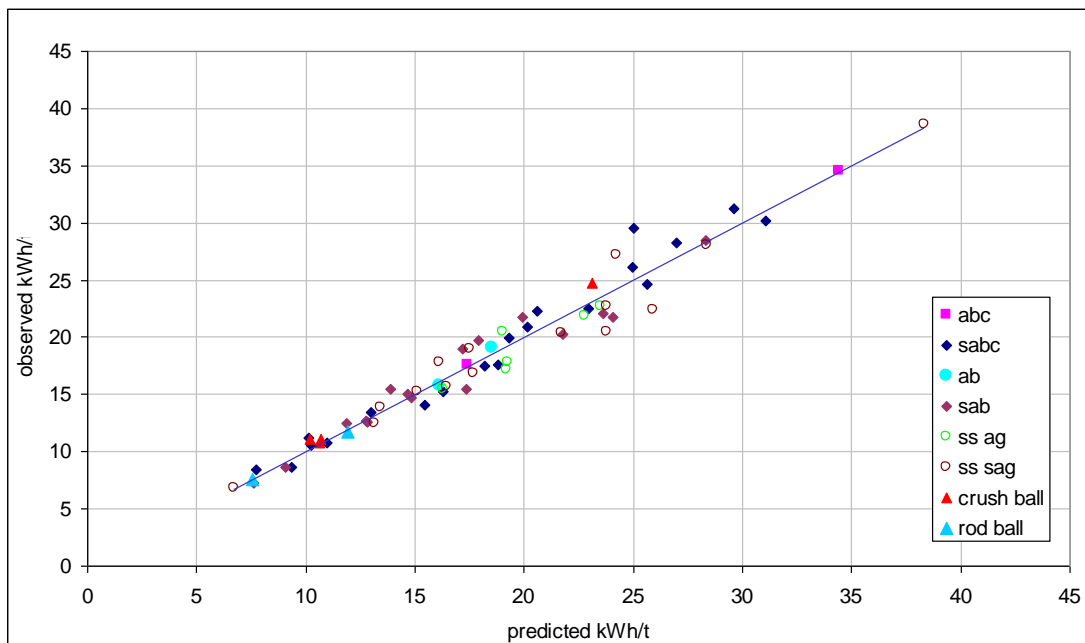

App Figure 11 – Observed vs Predicted Tumbling Mill Specific Energy

B 3.3.2 Conventional Crushers

Validation used 12 different crushing circuits (25 data sets), including secondary, tertiary and pebble crushers in AG/SAG circuits. Observed vs predicted specific energies are given in App Figure 12. The observed specific energies were calculated from the crusher throughput and the net power draw of the crusher as defined by:

$$\text{Net Power} = \text{Motor Input Power} - \text{No Load Power} \quad \text{Equation 15}$$

No-load power tends to be relatively high in conventional crushers and hence net power is significantly lower than the motor input power. From examination of the 25 crusher data sets the motor input power was found to be on average 20% higher than the net power.

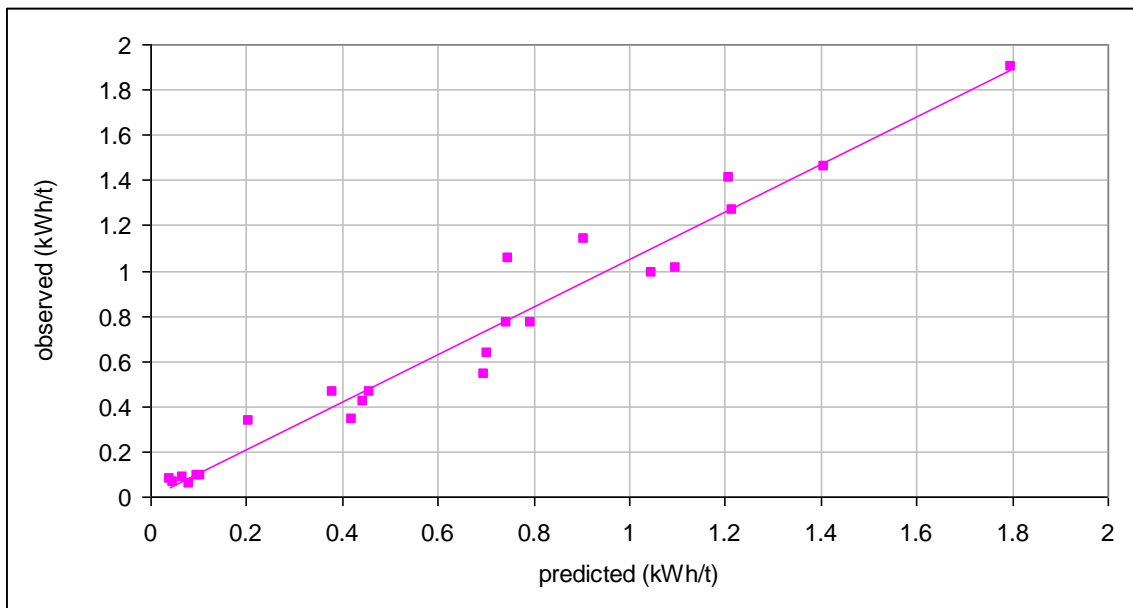

App Figure 12 – Observed vs Predicted Conventional Crusher Specific Energy

B 3.3.3 HPGRs

Validation for HPGRs used data from 19 different circuits (36 data sets) including laboratory, pilot and industrial scale equipment. Observed vs predicted specific energies are given in App Figure 13. The data relate to HPGRs operating with specific grinding forces typically in the range 2.5-3.5 N/mm². The observed specific energies relate to power delivered by the roll drive shafts. Motor input power for full scale machines is expected to be 8-10% higher.

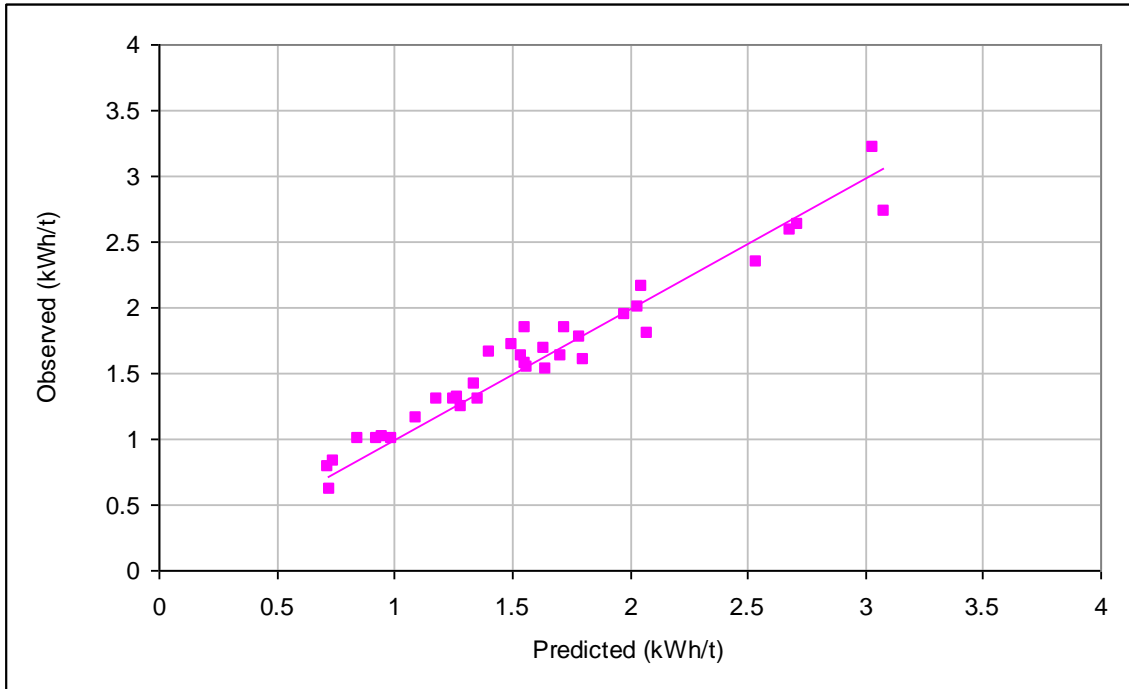

App Figure 13 – Observed vs Predicted HPGR Specific Energy

B 4 WORKED EXAMPLES

A SMC Test® and Bond ball work index test were carried out on a representative ore sample. The following results were obtained:

SMC Test®:

$$M_{ia} = 19.4 \text{ kWh/t}$$

$$M_{ic} = 7.2 \text{ kWh/t}$$

$$M_{ih} = 13.9 \text{ kWh/t}$$

Bond test carried out with a 150 micron closing screen:

$$M_{ib} = 18.8 \text{ kWh/t}$$

Three circuits are to be evaluated:

- SABC
- HPGR/ball mill
- Conventional crushing/ball mill

The overall specific grinding energy to reduce a primary crusher product with a P₈₀ of 100 mm to a final product P₈₀ of 106 µm needs to be estimated.

B 4.1 SABC Circuit

Coarse particle tumbling mill specific energy:

$$W_a = 0.95 * 19.4 * 4 * \left(750^{-0.295+750/1000000} - 100000^{-0.295+100000/1000000} \right)$$

$$= 9.6 \text{ kWh/t}$$

Fine particle tumbling mill specific energy:

$$W_b = 18.8 * 4 * \left(106^{-0.295+106/1000000} - 750^{-0.295+750/1000000} \right)$$

$$= 8.4 \text{ kWh/t}$$

Pebble crusher specific energy:

In this circuit, it is assumed that the pebble crusher feed P_{80} is 52.5mm. As a rule of thumb this value can be estimated by assuming that it is 0.75 of the nominal pebble port aperture (in this case the pebble port aperture is 70mm). The pebble crusher is set to give a product P_{80} of 12mm. The pebble crusher feed rate is expected to be 25% of new feed tph.

$$W_c = 1.19 * 7.2 * 4 * \left(12000^{-0.295+12000/1000000} - 52500^{-0.295+52500/1000000} \right)$$

$$= 1.12 \text{ kWh/t when expressed in terms of the crusher feed rate}$$

$$= 1.12 * 0.25 \text{ kWh/t when expressed in terms of the SABC circuit new feed rate}$$

$$= 0.3 \text{ kWh/t of SAG mill circuit new feed}$$

Total net comminution specific energy:

$$W_T = 9.6 + 8.4 + 0.3 \text{ kWh/t}$$

$$= 18.3 \text{ kWh/t}$$

B 4.2 HPGR/Ball Milling Circuit

In this circuit primary crusher product is reduced to a HPGR circuit feed P_{80} of 35 mm by closed circuit secondary crushing. The HPGR is also in closed circuit and reduces the 35 mm feed to a circuit product P_{80} of 4 mm. This is then fed to a closed circuit ball mill which takes the grind down to a P_{80} of 106 μm .

Secondary crushing specific energy:

$$W_c = 1 * 55 * \left(35000 * 100000 \right)^{-0.2} * 7.2 * 4 * \left(35000^{-0.295+35000/1000000} - 100000^{-0.295+100000/1000000} \right)$$

$$= 0.4 \text{ kWh/t}$$

HPGR specific energy:

$$W_h = 1 * 35 * \left(4000 * 35000 \right)^{-0.2} * 13.9 * 4 * \left(4000^{-0.295+4000/1000000} - 35000^{-0.295+35000/1000000} \right)$$

$$= 2.4 \text{ kWh/t}$$

Coarse particle tumbling mill specific energy:

$$W_a = 1 * 19.4 * 4 * \left(750^{-0.295+750/1000000} - 4000^{-0.295+4000/1000000} \right)$$

$$= 4.5 \text{ kWh/t}$$

Fine particle tumbling mill specific energy:

$$W_b = 18.8 * 4 * \left(106^{-0.295+106/1000000} - 750^{-0.295+750/1000000} \right)$$

$$= 8.4 \text{ kWh/t}$$

Total net comminution specific energy:

$$\begin{aligned} W_T &= 4.5 + 8.4 + 0.4 + 2.4 \quad \text{kWh/t} \\ &= 15.7 \text{ kWh/t} \end{aligned}$$

B 4.3 Conventional Crushing/Ball Milling Circuit

In this circuit primary crusher product is reduced in size to P₈₀ of 6.5 mm via a secondary/tertiary crushing circuit (closed). This is then fed to a closed circuit ball mill which grinds to a P80 of 106 µm.

Secondary/tertiary crushing specific energy:

$$\begin{aligned} W_c &= 1 * 7.2 * 4 * \left(6500^{-0.295+6500/1000000} - 100000^{-0.295+100000/1000000} \right) \\ &= 1.7 \text{ kWh/t} \end{aligned}$$

Coarse particle tumbling mill specific energy :

$$\begin{aligned} W_a &= 1 * 19.4 * 4 * \left(750^{-0.295+750/1000000} - 6500^{-0.295+6500/1000000} \right) \\ &= 5.5 \text{ kWh/t} \end{aligned}$$

Fine particle tumbling mill specific energy:

$$\begin{aligned} W_b &= 18.8 * 4 * \left(106^{-0.295+106/1000000} - 750^{-0.295+750/1000000} \right) \\ &= 8.4 \text{ kWh/t} \end{aligned}$$

Size distribution correction;

$$\begin{aligned} W_s &= 0.19 * 19.4 * 4 * \left(6500^{-0.295+6500/1000000} - 100000^{-0.295+100000/1000000} \right) \\ &= 0.9 \text{ kWh/t} \end{aligned}$$

Total net comminution specific energy:

$$\begin{aligned} W_T &= 5.5 + 8.4 + 1.7 + 0.9 \quad \text{kWh/t} \\ &= 16.5 \text{ kWh/t} \end{aligned}$$

Appendix D – Batch Flotation Testing

Test: F24 **Project:** 18559-01 **Date:** August 16, 2021 **Operator:** Deepak

Purpose: Conduct rougher kinetics test on LG Comp, target ~90 um

Procedure: As outlined below.

Feed: 2kg LG Comp -10 mesh Freezer\SEC-36E Box 116686

Grind: 42 minutes at 65% solids in 2 kg Rod Mill #3 Comb Prod P₈₀ = 90 µm

Regrind: N/A

Note:
1. Request Comb Prod S/A
2. Assay: Cu, Ni, S, Pt, Pd

Conditions:

Stage	Reagents added, grams per tonne						Time, minutes			pH	ORP, mV
	Lime	Aero Maxgold 900	PAX	MIBC*			Grind	Cond.	Froth		
Location		12A									
Grind	0	5					42			8.4	211
Cu/Ni Rougher No. 1	50			0				1	1	9.0	172
Cu/Ni Rougher No. 2	10		5	0				1	2	9.0	160
Cu/Ni Rougher No. 3	25		5	5				1	2	9.0	158
Po Rougher No. 1	0		10	2.5				1	3	natural pH	155
Po Rougher No. 2	0		10	5				1	5	natural pH	166
Po Rougher No. 3	0		10	10				1	5	natural pH	178
Total	85	5	40	22.5	0				18		

* Add as required.

Stage	Rougher/Scavenger	Po Rougher	Cu/Ni 1st/2nd Cleaner	Po 1st & 2nd Cl
Flotation Cell	2 kg float cell	2 kg float cell	500g/250g float cell	250g float cell
Speed: r.p.m.	1800	1800	1500/1200	1200

Metallurgical Balance

Product	Weight		Assays, %, g/t											% Distribution									
	g	%	Cu	Ni	S	Other	Pt, g/t	Pd, g/t	Au, g/t	Cp	Pn	Po	Ga	Cu	Ni	S	Pt	Pd	Au	Cp	Pn	Po	Ga
Cu/Ni Ro Conc 1	84.4	4.2	7.39	4.01	23.9	64.7	1.53	8.76	0.67	21.7	10.5	35.6	32.2	59.0	40.1	18.1	33.4	45.3	35.2	59.0	48.5	11.7	1.6
Cu/Ni Ro Conc 2	100.5	5.0	2.43	2.22	26.8	68.6	0.73	3.29	0.32	7.13	5.24	61.1	26.5	23.1	26.4	24.2	19.0	20.2	20.0	23.1	28.8	24.0	1.6
Cu/Ni Ro Conc 3	55.8	2.8	1.19	1.38	26.5	70.9	0.52	2.00	0.20	3.49	2.87	65.6	28.0	6.3	9.1	13.3	7.5	6.8	7.0	6.3	8.7	14.3	0.9
Po Ro Conc 1	61.4	3.0	0.31	0.83	25.8	73.1	0.30	0.94	0.09	0.91	1.33	67.4	30.4	1.8	6.0	14.2	4.8	3.5	3.4	1.8	4.5	16.2	1.1
Po Ro Conc 2	51.7	2.6	0.28	0.62	19.7	79.4	0.28	0.84	0.08	0.82	0.96	51.4	46.8	1.4	3.8	9.1	3.7	2.7	2.6	1.4	2.7	10.4	1.4
Po Ro Conc 3	30.0	1.5	0.27	0.52	16.4	82.8	0.26	0.82	0.07	0.79	0.80	42.7	55.7	0.8	1.8	4.4	2.0	1.5	1.3	0.8	1.3	5.0	1.0
Po Ro Tails	1631.4	81.0	0.05	0.07	1.14	98.7	0.07	0.20	0.03	0.15	0.06	2.88	96.9	7.7	12.7	16.7	29.6	20.0	30.5	7.7	5.5	18.4	92.5
Head (Calc.)	2015.2	100	0.52	0.42	5.53	93.5	0.19	0.81	0.08	1.54	0.91	12.7	84.9	100	100	100	100	100	100	100	100	100	100
Head (Dir.)			0.55	0.44	5.76	93.3	0.18	0.82	0.07	1.61	0.96	13.2	84.2										

Combined Products

Cu/Ni Ro Conc 1	84.4	4.2	7.39	4.01	23.9	64.7	1.53	8.76	0.67	21.7	10.5	35.6	32.2	59.0	40.1	18.1	33.4	45.3	35.2	59.0	48.5	11.7	1.6
Cu/Ni Ro Conc 1-2	184.9	9.2	4.69	3.04	25.5	66.8	1.10	5.79	0.48	13.8	7.64	49.5	29.1	82.1	66.5	42.3	52.4	65.5	55.2	82.1	77.2	35.8	3.1
Cu/Ni Ro Conc 1-3	240.7	11.9	3.88	2.65	25.7	67.8	0.96	4.91	0.41	11.4	6.53	53.2	28.9	88.4	75.6	55.5	59.9	72.3	62.2	88.4	86.0	50.1	4.1
Po Ro Conc 1	61.4	3.0	0.31	0.83	25.8	73.1	0.30	0.94	0.09	0.91	1.33	67.4	30.4	1.8	6.0	14.2	4.8	3.5	3.4	1.8	4.5	16.2	1.1
Po Ro Conc 1-2	113.1	5.6	0.30	0.73	23.0	76.0	0.29	0.89	0.09	0.87	1.16	60.1	37.9	3.2	9.8	23.4	8.5	6.2	6.0	3.2	7.2	26.6	2.5
Po Ro Conc 1-3	143.1	7.1	0.29	0.69	21.6	77.4	0.28	0.88	0.08	0.85	1.08	56.4	41.6	3.9	11.7	27.8	10.5	7.7	7.3	3.9	8.5	31.6	3.5
Cu/Ni & Po Ro Conc 1-3	383.8	19.0	2.54	1.92	24.2	71.3	0.71	3.41	0.29	7.46	4.50	54.4	33.6	92.3	87.3	83.3	70.4	80.0	69.5	92.3	94.5	81.6	7.5
Po Ro Feed	1774.5	88.1	0.07	0.12	2.79	97.0	0.09	0.25	0.03	0.20	0.14	7.2	92.5	11.6	24.4	44.5	40.1	27.7	37.8	11.6	14.0	49.9	95.9

Test: F25 **Project:** 18559-01 **Date:** August 16, 2021 **Operator:** Deepak

Purpose: Conduct rougher kinetics test on LG Comp, target ~120 um

Procedure: As outlined below.

Feed: 2kg LG Comp -10 mesh Freezer\SEC-36E Box 116686

Grind: 32 minutes at 65% solids in 2 kg Rod Mill #3 Comb Prod P₈₀ = 120 µm

Regrind: N/A

Note:
 1. Request Comb Prod S/A
 2. Assay: Cu, Ni, S, Pt, Pd

Conditions:

Stage	Reagents added, grams per tonne						Time, minutes			pH	ORP, mV
	Lime	Aero Maxgold 900	PAX	MIBC*			Grind	Cond.	Froth		
Location		12A									
Grind	50	5					32			8.8	189
Cu/Ni Rougher No. 1	20	5		0				1	1.5	9.0	128
Cu/Ni Rougher No. 2	25	5	1	0				1	2	9.0	149
Cu/Ni Rougher No. 3	25	2.5	5	5				1	2	9.0	153
Po Rougher No. 1	0		10	5				1	3	natural pH	166
Po Rougher No. 2	0		10	10				1	5	natural pH	171
Po Rougher No. 3	0		10	15				1	5	natural pH	180
Total	70	17.5	36	35	0				18.5		

* Add as required.

Stage	Rougher/Scavenger	Po Rougher	Cu/Ni 1st/2nd Cleaner	Po 1st & 2nd Cl
Flotation Cell	2 kg float cell	2 kg float cell	500g/250g float cell	250g float cell
Speed: r.p.m.	1800	1800	1500/1200	1200

Metallurgical Balance

Product	Weight		Assays, %, g/t											% Distribution									
	g	%	Cu	Ni	S	Other	Pt, g/t	Pd, g/t	Au, g/t	Cp	Pn	Po	Ga	Cu	Ni	S	Pt	Pd	Au	Cp	Pn	Po	Ga
Cu/Ni Ro Conc 1	104.1	5.2	6.75	3.93	25.4	63.9	1.36	7.74	0.74	19.8	10.2	41.6	28.4	65.2	46.4	22.7	35.6	48.2	45.9	65.2	55.5	16.2	1.7
Cu/Ni Ro Conc 2	91.3	4.5	2.05	1.88	26.5	69.6	0.67	3.26	0.44	6.01	4.29	62.1	27.6	17.4	19.5	20.8	15.4	17.8	23.9	17.4	20.4	21.2	1.5
Cu/Ni Ro Conc 3	63.3	3.1	0.83	1.27	26.7	71.2	0.48	1.68	0.14	2.43	2.54	67.4	27.6	4.9	9.1	14.5	7.6	6.4	5.3	4.9	8.4	15.9	1.0
Po Ro Conc 1	46.4	2.3	0.37	0.84	23.2	75.6	0.32	0.95	0.08	1.09	1.45	60.1	37.3	1.6	4.4	9.3	3.7	2.6	2.2	1.6	3.5	10.4	1.0
Po Ro Conc 2	34.1	1.7	0.32	0.66	19.3	79.7	0.28	0.94	0.09	0.94	1.09	50.1	47.9	1.0	2.6	5.7	2.4	1.9	1.8	1.0	1.9	6.4	1.0
Po Ro Conc 3	26.5	1.3	0.27	0.59	18.5	80.6	0.32	0.85	0.08	0.79	0.92	48.2	50.1	0.7	1.8	4.2	2.1	1.3	1.3	0.7	1.3	4.8	0.8
Po Ro Tails	1650.7	81.9	0.06	0.09	1.61	98.2	0.08	0.22	0.02	0.18	0.10	4.08	95.6	9.3	16.3	22.8	33.2	21.7	19.7	9.3	9.0	25.1	93.0
Head (Calc.)	2016.4	100	0.53	0.44	5.77	93.3	0.20	0.83	0.08	1.57	0.95	13.3	84.2	100	100	100	100	100	100	100	100	100	100
Head (Dir.)			0.55	0.44	5.76	93.3	0.18	0.82	0.07	1.61	0.96	13.2	84.2										

Combined Products

Cu/Ni Ro Conc 1		5.2	6.75	3.93	25.4	63.9	1.36	7.74	0.74	19.8	10.2	41.6	28.4	65.2	46.4	22.7	35.6	48.2	45.9	65.2	55.5	16.2	1.7
Cu/Ni Ro Conc 1-2		9.7	4.55	2.97	25.9	66.6	1.04	5.65	0.60	13.4	7.44	51.2	28.0	82.5	65.9	43.5	50.9	66.0	69.8	82.5	75.9	37.4	3.2
Cu/Ni Ro Conc 1-3		12.8	3.64	2.56	26.1	67.7	0.90	4.68	0.49	10.7	6.24	55.2	27.9	87.4	75.0	58.0	58.6	72.4	75.0	87.4	84.3	53.3	4.3
Po Ro Conc 1		2.3	0.37	0.84	23.2	75.6	0.32	0.95	0.08	1.09	1.45	60.1	37.3	1.6	4.4	9.3	3.7	2.6	2.2	1.6	3.5	10.4	1.0
Po Ro Conc 1-2		4.0	0.35	0.76	21.5	77.3	0.30	0.95	0.08	1.02	1.30	55.9	41.8	2.6	7.0	14.9	6.1	4.6	4.0	2.6	5.4	16.8	2.0
Po Ro Conc 1-3		5.3	0.33	0.72	20.8	78.2	0.31	0.92	0.08	0.97	1.20	54.0	43.8	3.3	8.7	19.1	8.3	5.9	5.3	3.3	6.7	21.6	2.8
Cu/Ni & Po Ro Conc 1-3		18.1	2.67	2.02	24.6	70.8	0.73	3.58	0.37	7.8	4.77	54.8	32.6	90.7	83.7	77.2	66.8	78.3	80.3	90.7	91.0	74.9	7.0
Po Ro Feed		87.2	0.08	0.13	2.78	97.0	0.09	0.26	0.02	0.23	0.17	7.1	92.5	12.6	25.0	42.0	41.4	27.6	25.0	12.6	15.7	46.7	95.7

Test: F26 **Project:** 18559-01 **Date:** August 16, 2021 **Operator:** Deepak

Purpose: Conduct rougher kinetics test on LG Comp, target ~150 um

Procedure: As outlined below.

Feed: 2kg LG Comp -10 mesh Freezer\SEC-36E Box 116686

Grind: 25 minutes at 65% solids in 2 kg Rod Mill #3 Comb Prod P₈₀ = 165 µm

Regrind: N/A

Note:
1. Request Comb Prod S/A
2. Assay: Cu, Ni, S, Pt, Pd

Conditions:

Stage	Reagents added, grams per tonne						Time, minutes			pH	ORP, mV
	Lime	Aero Maxgold 900	PAX	MIBC*			Grind	Cond.	Froth		
Location		12A									
Grind	75	5					25			8.9	174
Cu/Ni Rougher No. 1	5	2.5		0				1	1	9.0	163
Cu/Ni Rougher No. 2	10	5	1	0				1	2	9.0	148
Cu/Ni Rougher No. 3	20	0	5	5				1	2	9.0	148
Po Rougher No. 1	0		10	5				1	3	natural pH	156
Po Rougher No. 2	0		10	10				1	5	natural pH	168
Po Rougher No. 3	0		10	15				1	5	natural pH	178
Total	35	12.5	36	35	0				18		

* Add as required.

Stage	Rougher/Scavenger	Po Rougher	Cu/Ni 1st/2nd Cleaner	Po 1st & 2nd Cl
Flotation Cell	2 kg float cell	2 kg float cell	500g/250g float cell	250g float cell
Speed: r.p.m.	1800	1800	1500/1200	1200

Metallurgical Balance

Product	Weight		Assays, %, g/t											% Distribution									
	g	%	Cu	Ni	S	Other	Pt, g/t	Pd, g/t	Au, g/t	Cp	Pn	Po	Ga	Cu	Ni	S	Pt	Pd	Au	Cp	Pn	Po	Ga
Cu/Ni Ro Conc 1	60.4	3.0	7.83	4.25	25.8	62.1	1.68	9.76	0.78	23.0	11.1	39.0	26.9	45.5	31.0	13.9	24.6	34.8	29.2	45.5	37.8	9.1	1.0
Cu/Ni Ro Conc 2	90.2	4.5	3.64	2.46	26.6	67.3	1.02	4.93	0.62	10.7	5.96	56.7	26.6	31.6	26.8	21.4	22.3	26.2	34.7	31.6	30.2	19.8	1.4
Cu/Ni Ro Conc 3	53.5	2.7	1.34	1.41	24.4	72.9	0.62	2.26	0.22	3.93	3.03	59.4	33.6	6.9	9.1	11.6	8.0	7.1	7.3	6.9	9.1	12.3	1.1
Po Ro Conc 1	61.8	3.1	0.43	0.93	24.9	73.7	0.39	1.18	0.10	1.26	1.64	64.4	32.7	2.6	6.9	13.7	5.8	4.3	3.8	2.6	5.7	15.4	1.2
Po Ro Conc 2	41.1	2.0	0.42	0.80	19.3	79.5	0.37	1.08	0.08	1.23	1.48	49.5	47.8	1.7	4.0	7.1	3.7	2.6	2.0	1.7	3.4	7.9	1.2
Po Ro Conc 3	49.5	2.5	0.29	0.70	17.9	81.1	0.29	0.85	0.08	0.85	1.24	46.3	51.6	1.4	4.2	7.9	3.5	2.5	2.5	1.4	3.5	8.9	1.5
Po Ro Tails	1652.5	82.3	0.07	0.09	1.65	98.2	0.08	0.23	0.02	0.19	0.11	4.17	95.5	10.3	18.0	24.3	32.0	22.4	20.5	10.3	10.3	26.6	92.7
Head (Calc.)	2009.0	100	0.52	0.41	5.58	93.5	0.21	0.84	0.08	1.52	0.89	12.9	84.7	100	100	100	100	100	100	100	100	100	100
Head (Dir.)			0.55	0.44	5.76	93.3	0.18	0.82	0.07	1.61	0.96	13.2	84.2										

Combined Products

Cu/Ni Ro Conc 1		3.0	7.83	4.25	25.8	62.1	1.68	9.76	0.78	23.0	11.1	39.0	26.9	45.5	31.0	13.9	24.6	34.8	29.2	45.5	37.8	9.1	1.0
Cu/Ni Ro Conc 1-2		7.5	5.32	3.18	26.3	65.2	1.28	6.87	0.68	15.6	8.03	49.6	26.7	77.2	57.8	35.3	46.9	61.0	63.9	77.2	68.0	28.9	2.4
Cu/Ni Ro Conc 1-3		10.2	4.28	2.71	25.8	67.2	1.11	5.66	0.56	12.5	6.72	52.2	28.5	84.1	66.9	47.0	54.9	68.2	71.2	84.1	77.1	41.2	3.4
Po Ro Conc 1		3.1	0.43	0.93	24.9	73.7	0.39	1.18	0.10	1.26	1.64	64.4	32.7	2.6	6.9	13.7	5.8	4.3	3.8	2.6	5.7	15.4	1.2
Po Ro Conc 1-2		5.1	0.43	0.88	22.7	76.0	0.38	1.14	0.09	1.25	1.58	58.4	38.7	4.2	10.9	20.8	9.5	6.9	5.9	4.2	9.1	23.3	2.3
Po Ro Conc 1-3		7.6	0.38	0.82	21.1	77.7	0.35	1.05	0.09	1.12	1.47	54.5	42.9	5.6	15.1	28.7	13.0	9.4	8.3	5.6	12.6	32.1	3.8
Cu/Ni & Po Ro Conc 1-3		17.7	2.61	1.90	23.8	71.7	0.79	3.69	0.36	7.7	4.47	53.2	34.7	89.7	82.0	75.7	68.0	77.6	79.5	89.7	89.7	73.4	7.3
Po Ro Feed		89.8	0.09	0.15	3.29	96.5	0.10	0.30	0.03	0.27	0.23	8.4	91.1	15.9	33.1	53.0	45.1	31.8	28.8	15.9	22.9	58.8	96.6

Test: F27 **Project:** 18559-01 **Date:** August 16, 2021 **Operator:** Deepak

Purpose: Conduct rougher kinetics test on HG Comp, target ~90 um

Procedure: As outlined below.

Feed: 2kg HG Comp -10 mesh Freezer\SEC-19E Box 116703/116702

Grind: 34 minutes at 65% solids in 2 kg Rod Mill #3 Comb Prod P₈₀ = 87 µm

Regrind: N/A

Note:
1. Request Comb Prod S/A
2. Assay: Cu, Ni, S, Pt, Pd

Conditions:

Stage	Reagents added, grams per tonne						Time, minutes			pH	ORP, mV
	Lime	Aero Maxgold 900	PAX	MIBC*			Grind	Cond.	Froth		
Location		12A									
Grind	0	5					34			8.4	187
Cu/Ni Rougher No. 1	80	5		0				1	1	9.0	115
Cu/Ni Rougher No. 2	50	2.5	5	0				1	2	9.0	147
Cu/Ni Rougher No. 3	30	2.5	5	2.5				1	2	9.0	151
Po Rougher No. 1	0		10	5				1	3	natural pH	168
Po Rougher No. 2	0		10	10				1	5	natural pH	175
Po Rougher No. 3	0		10	15				1	5	natural pH	185
Total	160	15	40	32.5	0				18		

* Add as required.

Stage	Rougher/Scavenger	Po Rougher	Cu/Ni 1st/2nd Cleaner	Po 1st & 2nd Cl
Flotation Cell	2 kg float cell	2 kg float cell	500g/250g float cell	250g float cell
Speed: r.p.m.	1800	1800	1500/1200	1200

Metallurgical Balance

Product	Weight		Assays, %, g/t											% Distribution									
	g	%	Cu	Ni	S	Other	Pt, g/t	Pd, g/t	Au, g/t	Cp	Pn	Po	Ga	Cu	Ni	S	Pt	Pd	Au	Cp	Pn	Po	Ga
Cu/Ni Ro Conc 1	101.7	5.1	8.23	5.87	28.6	57.3	2.48	13.2	0.97	24.1	15.5	41.7	18.6	62.2	40.3	13.9	38.6	52.1	44.9	62.2	48.3	8.5	1.3
Cu/Ni Ro Conc 2	125.7	6.3	2.18	2.70	30.7	64.4	1.10	4.16	0.51	6.39	6.43	71.3	15.9	20.4	22.9	18.5	21.2	20.3	29.2	20.4	24.7	18.0	1.4
Cu/Ni Ro Conc 3	64.1	3.2	1.05	1.81	31.5	65.6	0.70	1.94	0.14	3.08	3.88	78.6	14.5	5.0	7.8	9.7	6.9	4.8	4.1	5.0	7.6	10.1	0.6
Po Ro Conc 1	92.7	4.6	0.33	1.19	30.6	67.9	0.36	0.99	0.07	0.97	2.16	79.5	17.3	2.3	7.4	13.6	5.1	3.6	3.0	2.3	6.1	14.8	1.1
Po Ro Conc 2	118.6	5.9	0.22	0.89	29.6	69.3	0.29	0.68	0.06	0.65	1.36	77.8	20.2	1.9	7.1	16.8	5.3	3.1	3.2	1.9	4.9	18.6	1.7
Po Ro Conc 3	83.9	4.2	0.16	0.69	25.4	73.8	0.26	0.55	0.07	0.47	0.95	67.0	31.5	1.0	3.9	10.2	3.3	1.8	2.7	1.0	2.4	11.3	1.8
Po Ro Tails	1424.3	70.8	0.07	0.11	2.52	97.3	0.09	0.26	0.02	0.20	0.14	6.48	93.2	7.2	10.6	17.2	19.6	14.4	13.0	7.2	5.9	18.6	92.1
Head (Calc.)	2011.0	100	0.67	0.74	10.4	88.2	0.32	1.28	0.11	1.96	1.63	24.7	71.7	100	100	100	100	100	100	100	100	100	100
Head (Dir.)			0.66	0.77	10.5	88.1	0.37	1.28	0.08	1.94	1.71	25.0	71.3										

Combined Products

Cu/Ni Ro Conc 1		5.1	8.23	5.87	28.6	57.3	8.2	5.9	28.6	24.1	15.5	41.7	18.6	62.2	40.3	13.9	38.6	52.1	44.9	62.2	48.3	8.5	1.3
Cu/Ni Ro Conc 1-2		11.3	4.89	4.12	29.8	61.2	4.9	4.1	29.8	14.3	10.50	58.1	17.1	82.6	63.1	32.5	59.8	72.3	74.1	82.6	73.0	26.6	2.7
Cu/Ni Ro Conc 1-3	291.5	14.5	4.04	3.61	30.1	62.2	4.0	3.6	30.1	11.9	9.05	62.6	16.5	87.6	71.0	42.1	66.7	77.2	78.2	87.6	80.6	36.7	3.3
Po Ro Conc 1		4.6	0.33	1.19	30.6	67.9	0.3	1.2	30.6	0.97	2.16	79.5	17.3	2.3	7.4	13.6	5.1	3.6	3.0	2.3	6.1	14.8	1.1
Po Ro Conc 1-2		10.5	0.27	1.02	30.0	68.7	0.3	1.0	30.0	0.79	1.71	78.6	18.9	4.2	14.6	30.4	10.4	6.7	6.2	4.2	11.1	33.4	2.8
Po Ro Conc 1-3		14.7	0.24	0.93	28.7	70.1	0.2	0.9	28.7	0.70	1.49	75.3	22.5	5.2	18.5	40.7	13.7	8.5	8.9	5.2	13.5	44.7	4.6
Cu/Ni & Po Ro Conc 1-3		29.2	2.13	2.26	29.4	66.2	2.1	2.3	29.4	6.24	5.25	69.0	19.5	92.8	89.4	82.8	80.4	85.6	87.0	92.8	94.1	81.4	7.9
Po Ro Feed		85.5	0.10	0.25	7.02	92.6	0.1	0.3	7.0	0.28	0.37	18.3	81.1	12.4	29.0	57.9	33.3	22.8	21.8	12.4	19.4	63.3	96.7

Test: F30 **Project:** 18559-01 **Date:** August 17, 2021 **Operator:** Deepak

Purpose: Based on F25, with DETA in the regrind.

Procedure: As outlined below.

Feed: 2kg LG Comp -10 mesh Freezer\SEC-36E Box 116686

Grind: 32 minutes at 65% solids in 2 kg Rod Mill # 3 P₈₀ =
Regrind: 7 minutes at 50% solids in 2 kg Rod Mill for Cu/Ni R.Conc Cu/Ni 1st CI Feed P₈₀ = N/A Malvern
 5 minutes at 50% solids in Attrition Mill for 1st CI Scav 1 Tails Cu/Ni 1st CI Feed P₈₀ = 17 µm Malvern

Note:
 1. Check Regrind size by Malvern, on the cleaner feed
 2. Assay: Cu, Ni, S, Pt, Pd, Au

Product	Wet Weight
Cu/Ni 1st CI Conc-1	130.57
Cu/Ni 1st CI Conc-2	70.23
Cu/Ni 1st CI Conc-3	16.32
Cu/Ni CI Scav1 Conc	11.55
Cu/Ni CI Scav2 Conc-1	8.61
Cu/Ni CI Scav2 Conc-2	5.66
Cu/Ni CI Scav2 Tails	141.64

Conditions:

Stage	Reagents added, grams per tonne						Time, minutes			pH	ORP, mV
	Lime	DETA	MaxGold 900	PAX	MIBC*		Grind	Cond.	Froth		
Grind	50		5				32			8.6	197
Cu/Ni Rougher No. 1	45		2.5		0			1	1	9.0	147
Cu/Ni Rougher No. 2	20		2.5	5	0			1	2	9.0	169
Cu/Ni Rougher No. 3	15		2.5	5	5			1	2	9.0	176
Regrind Comb Ro Conc(2kg Rod Mill)	100	10	2.5				7			9.3	171
Cu/Ni 1st Cleaner No.1	5			0				1	2	9.5	145
Cu/Ni 1st Cleaner No.2	0			2				1	2	~	177
Cu/Ni 1st Cleaner No.3	0			3				1	3	~	193
Cu/Ni 1st Cleaner Scav 1	30		2.5	5				1	3	9.5	172
Regrind Cu/Ni 1st CI Scav 1 Tails (Attrition Mill)	50			1			5			9.5	182
Cu/Ni CI Scav 2 No.1	10							1	2	9.5	154
Cu/Ni CI Scav 2 No.2	0			2				1	1.5	~	151
Did not perform CI Scav-3 Flot.											
Total	275	10	17.5	23	5	0		9	18.5		

Target ~40 um
Target 9.5

Target ~25 um
Target 9.5

* Add as required.

Stage	Rougher/Scavenger	Po Rougher	Cu/Ni 1st/2nd Cleaner	Po 1st & 2nd CI
Flotation Cell	2 kg float cell	2 kg float cell	500g/250g float cell	250g float cell
Speed: r.p.m.	1800	1800	1500/1200	1200

Metallurgical Balance

Product	Weight		Assays, %											% Distribution									
	g	%	Cu	Ni	S	Other	Pt, g/t	Pd, g/t	Au, g/t	Cp	Pn	Po	Ga	Cu	Ni	S	Pt	Pd	Au	Cp	Pn	Po	Ga
F30 Cu/Ni 1st CI Conc-1	116.7	5.8	6.09	3.85	33.3	56.8	1.43	7.61	0.57	17.9	9.7	65.0	7.4	68.4	53.8	32.4	38.7	53.1	44.1	68.4	63.7	27.2	0.5
F30 Cu/Ni 1st CI Conc-2	62.1	3.1	3.00	2.42	33.6	61.0	0.81	4.11	0.36	8.80	5.6	77.6	8.04	17.9	18.0	17.4	11.7	15.2	14.8	17.9	19.5	17.2	0.3
F30 Cu/Ni 1st CI Conc-3	13.4	0.7	1.24	1.67	33.7	63.4	0.52	2.14	0.18	3.64	3.4	84.4	8.56	1.6	2.7	3.8	1.6	1.7	1.6	1.6	2.6	4.0	0.1
F30 Cu/Ni CI Scav-1 Conc	6.8	0.3	0.25	0.83	31.5	67.4	0.23	0.71	0.12	0.73	1.13	83.1	15.1	0.2	0.7	1.8	0.4	0.3	0.5	0.2	0.4	2.0	0.1
F30 Cu/Ni CI Scav-2 Conc-1	5.4	0.3	0.58	0.41	9.21	89.8	0.66	1.48	0.36	1.70	0.75	22.6	75.0	0.3	0.3	0.4	0.8	0.5	1.3	0.3	0.2	0.4	0.2
F30 Cu/Ni CI Scav-2 Conc-2	3.3	0.2	0.43	0.48	12.7	86.4	0.82	1.21	0.47	1.26	0.82	32.3	65.6	0.1	0.2	0.3	0.6	0.2	1.0	0.1	0.2	0.4	0.1
F30 Cu/Ni CI Scav-2 Tails	95.0	4.7	0.07	0.17	4.84	94.9	0.11	0.24	0.04	0.21	0.22	12.6	86.9	0.7	1.9	3.8	2.4	1.4	2.5	0.7	1.2	4.3	4.9
F30 Cu/Ni Ro Tails	1711.7	85.0	0.07	0.11	2.80	97.0	0.11	0.27	0.03	0.19	0.13	7.24	92.4	10.9	22.5	40.0	43.7	27.6	34.1	10.9	12.2	44.4	93.8
Head (Calc.)	2014.4	100	0.52	0.41	5.95	93.1	0.21	0.83	0.07	1.51	0.88	13.9	83.7	100	100	100	100	100	100	100	100	100	100
Head (Dir.)			0.55	0.44	5.76	93.3	0.18	0.82	0.07	1.61	0.96	13.2	84.2										

Combined Products

Cu/Ni 1st CI Conc 1	116.7	5.8	6.09	3.85	33.3	56.8	1.43	7.61	0.57	17.9	9.7	65.0	7.4	68.4	53.8	32.4	38.7	53.1	44.1	68.4	63.7	27.2	0.5
Cu/Ni 1st CI Conc 1-2	178.8	8.9	5.02	3.35	33.4	58.2	1.21	6.39	0.50	14.7	8.3	69.4	7.6	86.3	71.7	49.8	50.4	68.3	59.0	86.3	83.2	44.4	0.8
Cu/Ni 1st CI Conc 1-3	192.2	9.5	4.75	3.24	33.4	58.6	1.17	6.10	0.47	13.9	7.9	70.4	7.7	87.9	74.4	53.6	52.0	70.0	60.6	87.9	85.8	48.5	0.9
Cu/Ni 1st CI Conc 1-3 & Scav1 Conc	199.0	9.9	4.60	3.15	33.4	58.9	1.13	5.91	0.46	13.5	7.7	70.9	8.0	88.0	75.1	55.4	52.4	70.3	61.1	88.0	86.2	50.5	0.9
Cu/Ni 1st CI Scav2 Conc-1	5.4	0.3	0.58	0.41	9.21	89.8	0.66	1.48	0.36	1.70	0.75	22.6	75.0	0.3	0.3	0.4	0.8	0.5	1.3	0.3	0.2	0.4	0.2
Cu/Ni 1st CI Scav2 Conc-1-2	8.7	0.4	0.52	0.44	10.5	88.5	0.72	1.38	0.40	1.53	0.78	26.3	71.4	0.4	0.5	0.8	1.5	0.7	2.3	0.4	0.4	0.8	0.4
Cu/Ni 1st CI Scav1 Tails	103.7	5.1	0.11	0.19	5.32	94.4	0.16	0.34	0.07	0.32	0.27	13.8	85.6	1.1	2.4	4.6	3.9	2.1	4.8	1.1	1.6	5.1	5.3
Cu/Ni Ro Conc 1-3	302.7	15.0	3.06	2.14	23.8	71.0	0.80	4.00	0.33	8.98	5.14	51.3	34.6	89.1	77.5	60.0	56.3	72.4	65.9	89.1	87.8	55.6	6.2

Test: F31 **Project:** 18559-01 **Date:** August 17, 2021 **Operator:** Deepak

Purpose: Based on F25, without DETA in the regrind.

Procedure: As outlined below.

Feed: 2kg LG Comp -10 mesh Freezer\SEC-36E Box 116686

Grind: 32 minutes at 65% solids in 2 kg Rod Mill # 3 P₈₀ =
Regrind: 7 minutes at 50% solids in 2 kg Rod Mill for Cu/Ni R.Conc Cu/Ni 1st CI Feed P₈₀ = 40 µm Malvern
 3 minutes at 50% solids in 2 kg Rod Mill for 1st CI Scav 1 Tails Cu/Ni 1st CI Scav 2 Feed P₈₀ = 22 µm Malvern
 3 minutes at 50% solids in Attrition Mill for 1st CI Scav 1 Tails Cu/Ni 1st CI Scav 3 Feed P₈₀ = 16 µm Malvern

Product	Wet Weigh
Cu/Ni 1st CI Conc-1	115.12
Cu/Ni 1st CI Conc-2	51.03
Cu/Ni 1st CI Conc-3	17.42
Cu/Ni CI Scav1 Conc	14.66
Cu/Ni CI Scav2 Conc-1	9.36
Cu/Ni CI Scav2 Conc-2	8.83
Cu/Ni CI Scav3 Conc-1	9.63
Cu/Ni CI Scav3 Conc-2	8.89
Cu/Ni CI Scav3 Tails	130.18

Note:
 1. Check Regrind size by Malvern, on the cleaner feed
 2. Assay: Cu, Ni, S, Pt, Pd, Au

Conditions:

Stage	Reagents added, grams per tonne						Time, minutes			pH	ORP, mV
	Lime	DETA	MaxGold 900	PAX	MIBC*	Grind	Cond.	Froth			
Grind	50		5			32			8.8	203	
Cu/Ni Rougher No. 1	20		2.5		0		1	1	9.0	174	
Cu/Ni Rougher No. 2	5		2.5	5	5		1	2	9.0	185	
Cu/Ni Rougher No. 3	25		2.5	5	5		1	2	9.0	181	
Regrind Comb Ro Conc(2kg Rod Mill)	100	0	1.25			7			9.0	197	Target ~40 um Target 9.5
Cu/Ni 1st Cleaner No.1	15			0			1	2	9.5	152	
Cu/Ni 1st Cleaner No.2	0			1			1	2	~	165	
Cu/Ni 1st Cleaner No.3	0			2			1	2	~	181	
Cu/Ni 1st Cleaner Scav 1	30		2.5	5			1	3	9.5	163	
Regrind Cu/Ni 1st CI Scav 1 Tails (Attrition Mill)	50			1		3			9.5	157	Target ~25 um Target 9.5
Cu/Ni CI Scav 2 No.1	0						1	2	9.5	157	
Cu/Ni CI Scav 2 No.2	0			2			1	3	~	169	
Regrind Cu/Ni CI Scav 2 Tails (Attrition Mill)	50			1		3			9.5	158	Target <20 um Target 9.5
Cu/Ni CI Scav 3 No.1	0						1	2	9.5	158	
Cu/Ni CI Scav 3 No.2	0			2			1	3	~	154	
Total	295	0	16.25	22	10	0	10	21			

Stage	Rougher/Scavenger	Po Rougher	Cu/Ni 1st/2nd Cleaner	Po 1st & 2nd CI
Flotation Cell	2 kg float cell	2 kg float cell	500g/250g float cell	250g float cell
Speed: r.p.m.	1800	1800	1500/1200	1200

Metallurgical Balance

Product	Weight		Assays, %											% Distribution									
	g	%	Cu	Ni	S	Other	Pt, g/t	Pd, g/t	Au, g/t	Cp	Pn	Po	Ga	Cu	Ni	S	Pt	Pd	Au	Cp	Pn	Po	Ga
F31 Cu/Ni 1st Cleaner Conc-1	104.0	5.2	6.93	4.15	34.0	54.9	1.6	7.7	2.16	20.3	10.5	64.0	5.19	68.7	50.3	30.8	41.3	50.4	66.7	68.7	59.0	25.1	0.3
F31 Cu/Ni 1st Cleaner Conc-2	45.4	2.3	3.92	3.07	34.6	58.4	1.1	5.3	0.88	11.5	7.4	76.3	4.84	17.0	16.2	13.7	12.6	15.1	11.9	17.0	18.1	13.1	0.1
F31 Cu/Ni 1st Cleaner Conc-3	12.7	0.6	1.40	2.15	34.0	62.5	0.6	2.3	0.30	4.11	4.8	83.6	7.51	1.7	3.2	3.8	1.8	1.8	1.1	1.7	3.3	4.0	0.1
F31 Cu/Ni Cleaner Scav-1 Conc	11.1	0.6	0.35	1.17	33.6	64.9	0.3	1.0	0.12	1.03	2.00	87.7	9.28	0.4	1.5	3.2	0.8	0.7	0.4	0.4	1.2	3.7	0.1
F31 Cu/Ni Cleaner Scav-2 Conc-1	6.2	0.3	0.67	0.89	18.7	79.7	0.8	1.8	1.29	1.96	1.76	47.0	49.3	0.4	0.6	1.0	1.2	0.7	2.4	0.4	0.6	1.1	0.2
F31 Cu/Ni Cleaner Scav-2 Conc-2	5.5	0.3	0.44	0.82	22.3	76.4	0.5	1.0	0.25	1.29	1.43	57.6	39.7	0.2	0.5	1.1	0.7	0.4	0.4	0.2	0.4	1.2	0.1
F31 Cu/Ni Cleaner Scav-3 Conc-1	5.8	0.3	0.40	0.57	12.9	86.1	0.5	1.0	0.25	1.17	1.06	32.7	65.1	0.2	0.4	0.7	0.6	0.4	0.4	0.2	0.3	0.7	0.2
F31 Cu/Ni Cleaner Scav-3 Conc-2	4.5	0.2	0.33	0.61	14.3	84.8	0.4	0.9	0.22	0.97	1.12	36.6	61.3	0.1	0.3	0.6	0.4	0.2	0.3	0.1	0.3	0.6	0.2
F31 Cu/Ni Cleaner Scav-3 Tails	90.2	4.5	0.12	0.26	7.78	91.8	0.1	0.3	0.04	0.35	0.37	20.3	79.0	1.0	2.7	6.1	2.7	1.9	1.1	1.0	1.8	6.9	4.2
F31 Cu/Ni Ro Tails	1728.0	85.8	0.06	0.12	2.60	97.2	0.1	0.3	0.03	0.18	0.16	6.69	93.0	10.2	24.2	39.1	38.1	28.4	15.4	10.2	15.0	43.6	94.5
Head (Calc.)	2013.4	100	0.52	0.43	5.70	93.3	0.20	0.78	0.17	1.53	0.92	13.2	84.4	100	100	100	100	100	100	100	100	100	100
Head (Dir.)			0.55	0.44	5.76	93.3	0.18	0.82	0.07	1.61	0.96	13.2	84.2										

Combined Products

Cu/Ni 1st Cl Conc 1	104.0	5.2	6.93	4.15	34.0	54.9	1.6	7.7	2.2	20.3	10.5	64.0	5.2	68.7	50.3	30.8	41.3	50.4	66.7	68.7	59.0	25.1	0.3
Cu/Ni 1st Cl Conc 1-2	149.4	7.4	6.02	3.82	34.2	56.0	1.5	6.9	1.8	17.6	9.6	67.7	5.1	85.7	66.5	44.5	53.8	65.5	78.5	85.7	77.1	38.2	0.4
Cu/Ni 1st Cl Conc 1-3	162.1	8.1	5.65	3.69	34.2	56.5	1.4	6.6	1.7	16.6	9.2	69.0	5.3	87.4	69.7	48.2	55.6	67.3	79.6	87.4	80.4	42.2	0.5
Cu/Ni 1st Cl Conc 1-3 & Scav1 Conc	173.2	8.6	5.31	3.53	34.1	57.0	1.3	6.2	1.6	15.6	8.7	70.2	5.5	87.8	71.2	51.5	56.4	68.0	80.0	87.8	81.6	45.9	0.6
Cu/Ni 1st Cl Scav2 Conc-1	6.2	0.3	0.67	0.89	18.7	79.7	0.8	1.8	1.3	1.96	1.76	47.0	49.3	0.4	0.6	1.0	1.2	0.7	2.4	0.4	0.6	1.1	0.2
Cu/Ni 1st Cl Scav2 Conc-1-2	11.7	0.6	0.56	0.86	20.4	78.2	0.6	1.4	0.8	1.65	1.60	52.0	44.8	0.6	1.2	2.1	1.8	1.1	2.8	0.6	1.0	2.3	0.3
Cu/Ni 1st Cl Scav2&3 Conc-1	17.5	0.9	0.51	0.76	17.9	80.8	0.6	1.3	0.6	1.49	1.42	45.6	51.5	0.8	1.6	2.7	2.5	1.4	3.2	0.8	1.3	3.0	0.5
Cu/Ni 1st Cl Scav2&3 Conc-1-2	22.0	1.1	0.47	0.73	17.2	81.6	0.5	1.2	0.5	1.38	1.36	43.7	53.5	1.0	1.9	3.3	2.9	1.7	3.5	1.0	1.6	3.6	0.7
Cu/Ni 1st Cl Scav1 Tails	112.2	5.6	0.19	0.35	9.62	89.8	0.2	0.5	0.1	0.55	0.57	24.9	74.0	2.0	4.6	9.4	5.5	3.6	4.6	2.0	3.4	10.5	4.9
Cu/Ni Ro Conc 1-3	190.7	9.5	4.87	3.28	32.6	59.2	1.3	5.8	1.5	14.3	8.06	67.9	9.7	88.6	72.8	54.2	58.9	69.4	83.3	88.6	82.9	48.9	1.1

Test: F32 **Project:** 18559-01 **Date:** August 20, 2021 **Operator:** Deepak

Purpose: Similar to F31, with CMC in the Cu/Ni 1st Cleaner

Procedure: As outlined below.

Feed: 2kg LG Comp -10 mesh Freezer\SEC-36E Box 116686

Grind: 42 minutes at 65% solids in 2 kg Rod Mill # 3 P₈₀ =
Regrind: 7 minutes at 50% solids in 2 kg Rod Mill for Cu/Ni R.Conc Cu/Ni 1st CI Feed P₈₀ = N/A Malvern
 4 minutes at 50% solids in Attrition Mill for 1st CI Scav 1 Tails Cu/Ni 1st CI Scav2 Feed P₈₀ = N/A Malvern
 4 minutes at 50% solids in Attrition Mill for 1st CI Scav 2 Tails Cu/Ni 1st CI Scav3 Feed P₈₀ = 15 µm Malvern

Product	Wet Weight
Cu/Ni 1st CI Conc-1	150.64
Cu/Ni 1st CI Conc-2	69.11
Cu/Ni 1st CI Conc-3	27.59
Cu/Ni CI Scav2 Conc	9.22
Cu/Ni CI Scav3 Conc	8.39
Cu/Ni CI Scav3 Tails	193.01

Note:
 1. Check Regrind size by Malvern, on the cleaner feed
 2. Assay: Cu, Ni, S, Pt, Pd, Au

Conditions:

Stage	Reagents added, grams per tonne						Time, minutes			pH	ORP, mV
	Lime	DETA	MaxGold 900	PAX	MIBC*	CMC	Grind	Cond.	Froth		
Grind	50		5				42			8.8	220
Cu/Ni Rougher No. 1	5		2.5		0			1	1	9.0	201
Cu/Ni Rougher No. 2	0		2.5	5	5			1	2	~9	212
Cu/Ni Rougher No. 3	0		2.5	5	5			1	2	~9	252
Po Rougher No. 1	0			10	5			1	3	natural pH	304
Po Rougher No. 2	0			10	15			1	5	natural pH	298
Po Rougher No. 3	0			10	10			1	5	natural pH	379
Regrind Cu/Ni +Po Ro Conc (2kg Rod M	200	0	1.25				7			9.3	410
Cu/Ni 1st Cleaner No.1	50			0		60		1	2	9.5	310
Cu/Ni 1st Cleaner No.2	0			1				1	2	~	252
Cu/Ni 1st Cleaner No.3	0			2				1	2	~	219
Regrind Cu/Ni 1st CI Scav 1 Tails (Attrition Mill)											
	50			1			4			9.5	321
Cu/Ni CI Scav 2 No.1	0					40		1	2	9.5	321
Regrind Cu/Ni CI Scav 2 Tails (Attrition Mill)											
	50			1			4			9.5	111
Cu/Ni CI Scav 3 No.1	0		2.5			20		1	2	9.5	111
Total	355	0	16.25	45	40	120		11	28		

Keep Cu/Ni and Po separate

Target ~40 um
Target 9.5

Target ~25 um
Target 9.5

Target <20 um
Target 9.5

Stage	Rougher/Scavenger	Po Rougher	Cu/Ni 1st/2nd Cleaner	Po 1st & 2nd CI
Flotation Cell	2 kg float cell	2 kg float cell	500g/250g float cell	250g float cell
Speed: r.p.m.	1800	1800	1500/1200	1200

Metallurgical Balance

Product	Weight		Assays, %											% Distribution									
	g	%	Cu	Ni	S	Other	Pt, g/t	Pd, g/t	Au, g/t	Cp	Pn	Po	Ga	Cu	Ni	S	Pt	Pd	Au	Cp	Pn	Po	Ga
F32 Cu/Ni 1st Cl Conc-1	145.5	7.2	5.35	3.48	33.8	57.4	1.38	6.84	0.76	15.7	8.6	69.3	6.43	77.0	61.6	44.6	51.3	60.9	57.3	77.0	70.8	39.6	0.5
F32 Cu/Ni 1st Cl Conc-2	62.5	3.1	1.58	1.87	32.8	63.8	0.60	2.81	0.26	4.63	4.0	80.5	10.8	9.8	14.2	18.6	9.6	10.7	8.4	9.8	14.2	19.8	0.4
F32 Cu/Ni 1st Cl Conc-3	23.9	1.2	1.12	1.53	32.2	65.2	0.50	2.26	0.18	3.28	3.1	81.0	12.7	2.6	4.4	7.0	3.1	3.3	2.2	2.6	4.2	7.6	0.2
F32 Cu/Ni Cl Scav-2 Conc-1	3.5	0.2	1.51	1.72	21.6	75.2	1.45	4.00	0.61	4.43	4.00	50.6	40.9	0.5	0.7	0.7	1.3	0.9	1.1	0.5	0.8	0.7	0.1
F32 Cu/Ni Cl Scav-3 Conc-1	6.1	0.3	1.30	1.09	11.4	86.2	0.97	3.82	0.47	3.81	2.59	25.0	68.6	0.8	0.8	0.6	1.5	1.4	1.5	0.8	0.9	0.6	0.2
F32 Cu/Ni Cl Scav-3 Tails	130.8	6.5	0.13	0.24	6.1	93.6	0.12	0.35	0.06	0.38	0.38	15.6	83.6	1.7	3.8	7.2	4.0	2.8	4.1	1.7	2.8	8.0	6.4
F32 Po Ro Tails	1637.4	81.5	0.05	0.07	1.44	98.4	0.07	0.20	0.03	0.14	0.07	3.7	96.1	7.6	14.3	21.4	29.3	20.0	25.4	7.6	6.3	23.7	92.1
Head (Calc.)	2009.7	100	0.50	0.41	5.49	93.6	0.19	0.81	0.10	1.48	0.88	12.7	85.0	100	100	100	100	100	100	100	100	100	100
Head (Dir.)			0.55	0.44	5.76	93.3	0.18	0.82	0.07	1.61	0.96	13.2	84.2										

Combined Products

Cu/Ni 1st Cl Conc 1	145.5	7.2	5.35	3.48	33.8		1.38	6.84	0.76	15.7	8.6	69.3	6.4	77.0	61.6	44.6	51.3	60.9	57.3	77.0	70.8	39.6	0.5
Cu/Ni 1st Cl Conc 1-2	208.0	10.3	4.22	3.00	33.5		1.15	5.63	0.61	12.4	7.2	72.7	7.7	86.8	75.8	63.2	60.9	71.6	65.7	86.8	85.1	59.4	0.9
Cu/Ni 1st Cl Conc 1-3	231.9	11.5	3.90	2.85	33.4		1.08	5.28	0.57	11.4	6.8	73.5	8.3	89.4	80.3	70.1	63.9	74.9	67.9	89.4	89.2	67.0	1.1
Cu/Ni 1st Cl Scav2 Conc	3.5	0.2	1.51	1.72	21.6		1.45	4.00	0.61	4.43	4.00	50.6	40.9	0.5	0.7	0.7	1.3	0.9	1.1	0.5	0.8	0.7	0.1
Cu/Ni 1st Cl Scav2&3 Conc	9.6	0.5	1.38	1.32	15.1		1.15	3.89	0.52	4.04	3.11	34.3	58.5	1.3	1.5	1.3	2.8	2.3	2.6	1.3	1.7	1.3	0.3
Cu/Ni 1st Cl Tails	140.4	7.0	0.22	0.31	6.67		0.19	0.59	0.09	0.63	0.56	16.9	81.9	3.0	5.4	8.5	6.8	5.1	6.7	3.0	4.5	9.3	6.7
Cu/Ni Ro Conc 1-3	372.3	18.5	2.51	1.89	23.3		0.74	3.51	0.39	7.36	4.45	52.2	36.0	92.4	85.7	78.6	70.7	80.0	74.6	92.4	93.7	76.3	7.9

Test: F33 **Project:** 18559-01 **Date:** August 20, 2021 **Operator:** Deepak

Purpose: Similar to F32, Keep Po Ro Conc and Cu/Ni Ro separate

Procedure: As outlined below.

Feed: 2kg LG Comp -10 mesh Freezer\SEC-36E Box 116686

Grind: 42 minutes at 65% solids in 2 kg Rod Mill # 3 P₈₀ =
Regrind: 5 minutes at 50% solids in 2 kg Rod Mill for Cu/Ni R.Conc Cu/Ni 1st CI Feed P₈₀ = N/A Malvern
 8 minutes at 50% solids in 2 kg Attrition Mill for Po 1st CI Po 1st CI Scav Tails P₈₀ = 28.5 µm Malvern

Product	Wet Weight
Cu/Ni 2nd CI Conc	49.67
Cu/Ni 2nd CI Tails	25.71
Cu/Ni 1st CI Scav Conc	13.31
Cu/Ni 1st CI Scav Tails	134.71
Po 1st CI Conc	28.12
Po 1st CI Scav Conc	16.69
Po 1st CI ScavTails	287.08
Po Ro Conc	166.93

- Note:**
1. Check Regrind size by Malvern, on the cleaner feed
 2. Assay: Cu, Ni, S, Pt, Pd, Au

Conditions:

Stage	Reagents added, grams per tonne						Time, minutes			pH	ORP, mV
	Lime	DETA	MaxGold 900	PAX	MIBC*	CMC	Grind	Cond.	Froth		
Grind	50		5				42			8.8	280
Cu/Ni Rougher No. 1	30		2.5		0			1	1	9.0	222
Cu/Ni Rougher No. 2	0		2.5	2.5	5			1	2	~9	206
Cu/Ni Rougher No. 3	0		2.5	2.5	5			1	2	~9	210
Po Rougher No. 1	0			10	5			1	3	natural pH	228
Po Rougher No. 2	0			10	10			1	5	natural pH	211
Po Rougher No. 3	0			10	10			1	5	natural pH	222
Regrind Cu/Ni Ro Conc (2kg Rod Mill)	125	0					5			9.7	120
Cu/Ni 1st Cleaner No.1	0		0	0		40		1	2	9.7	120
Cu/Ni 1st Cleaner No.2	0			1	7.5			1	2	~	153
Cu/Ni 1st Cleaner Scav	20		2.5	0	2.5			1	2	9.5	127
Cu/Ni 2nd Cleaner	10		0	0		0		1	3	9.5	139
Regrind Cu/Ni 1st CI Scav 1 Tails + Po Ro Conc 1-3 (Attrition Mill)	100						8			9.6	178
Po 1st Cleaner	0			1		40		1	2	9.6	178
Po 1st Cleaner Scav	0		2.5	0				1	2	~	167
Total	285	0	17.5	37	45	80		12	31		

Keep Cu/Ni and Po separate

Target ~40 um
Target 9.5

Target ~25 um
Target 9.5

Stage	Rougher/Scavenger	Po Rougher	Cu/Ni 1st/2nd Cleaner	Po 1st & 2nd CI
Flotation Cell	2 kg float cell	2 kg float cell	500g/250g float cell	250g float cell
Speed: r.p.m.	1800	1800	1500/1200	1200

Metallurgical Balance

Product	Weight		Assays, %											% Distribution									
	g	%	Cu	Ni	S	Other	Pt, g/t	Pd, g/t	Au, g/t	Cp	Pn	Po	Ga	Cu	Ni	S	Pt	Pd	Au	Cp	Pn	Po	Ga
F33 Cu/Ni 2nd Cl Conc	45.9	2.3	19.1	6.96	28.9	45.0	3.79	21.1	1.87	56.0	19.0	10.6	14.4	80.3	38.3	11.7	38.6	57.7	49.1	80.3	48.5	1.9	0.4
F33 Cu/Ni 2nd Cl Tails	15.6	0.8	1.61	5.65	30.2	62.5	1.03	3.68	0.36	4.72	14.6	64.5	16.2	2.3	10.6	4.2	3.6	3.4	3.2	2.3	12.7	3.9	0.1
F33 Cu/Ni 1st Cl Scav Conc	7.8	0.4	1.44	4.49	32.8	61.3	1.04	3.71	0.42	4.22	11.3	74.8	9.72	1.0	4.2	2.3	1.8	1.7	1.9	1.0	4.9	2.2	0.0
F33 Po 1st Cl Conc	18.9	0.9	1.78	4.06	33.8	60.4	1.76	5.01	0.56	5.22	10.1	77.6	7.13	3.1	9.2	5.6	7.4	5.6	6.1	3.1	10.6	5.6	0.1
F33 Po 1st Cl Scav Conc	9.1	0.5	1.06	2.73	34.5	61.7	0.95	3.19	0.40	3.11	6.33	84.5	6.01	0.9	3.0	2.8	1.9	1.7	2.1	0.9	3.2	3.0	0.0
F33 Po 1st Cl Scav Tails	212.2	10.6	0.19	0.58	22.0	77.2	0.19	0.59	0.07	0.56	0.76	58.0	40.7	3.7	14.8	41.1	8.9	7.5	8.5	3.7	9.0	47.2	5.1
F33 Po Ro Tails	1701.2	84.6	0.06	0.10	2.16	97.7	0.10	0.22	0.03	0.16	0.12	5.6	94.2	8.7	20.0	32.4	37.8	22.3	29.2	8.7	10.9	36.3	94.2
Head (Calc.)	2010.7	100	0.54	0.41	5.64	93.4	0.22	0.83	0.09	1.59	0.89	13.0	84.5	100	100	100	100	100	100	100	100	100	100
Head (Dir.)			0.55	0.44	5.76	93.3	0.18	0.82	0.07	1.61	0.96	13.2	84.2										

Combined Products

Cu/Ni 2nd Cl Conc 1	45.9	2.3	19.1	6.96	28.9		3.8	21.1	1.9	56.0	19.0	10.6	14.4	80.3	38.3	11.7	38.6	57.7	49.1	80.3	48.5	1.9	0.4
Cu/Ni 1st Cl Conc	61.5	3.1	14.7	6.63	29.2		3.1	16.7	1.5	43.0	17.9	24.3	14.9	82.6	48.9	15.8	42.2	61.1	52.3	82.6	61.3	5.7	0.5
Cu/Ni 1st Cl & Scav Conc	69.3	3.4	13.2	6.39	29.6		2.9	15.2	1.4	38.6	17.1	29.9	14.3	83.6	53.1	18.1	44.0	62.9	54.2	83.6	66.2	8.0	0.6
Po 1st Cl Conc	18.9	0.9	1.78	4.06	33.8		1.76	5.01	0.56	5.22	10.1	77.6	7.1	3.1	9.2	5.6	7.4	5.6	6.1	3.1	10.6	5.6	0.1
Po 1st Cl & Scav Conc	28.0	1.4	1.55	3.63	34.0		1.50	4.42	0.51	4.53	8.86	79.8	6.8	4.0	12.2	8.4	9.3	7.4	8.1	4.0	13.8	8.6	0.1
Cu/Ni 1st Cl Tails & Po Ro Conc 1-3	240.2	11.9	0.35	0.94	23.4		0.34	1.04	0.12	1.02	1.71	60.5	36.7	7.7	26.9	49.5	18.3	14.8	16.6	7.7	22.9	55.8	5.2
Cu/Ni Ro Conc 1-3 & Po Ro Conc	309.5	15.4	3.22	2.16	24.8		0.91	4.21	0.40	9.44	5.16	53.7	31.7	91.3	80.0	67.6	62.2	77.7	70.8	91.3	89.1	63.7	5.8
Cu/Ni 1st Cl & Scav Conc & Po 1st Cl & Scav Conc	4.8		9.83	5.59	30.9		2.5	12.1	1.1	28.8	14.7	44.3	12.1	87.6	65.3	26.5	53.3	70.2	62.3	87.6	80.0	16.5	0.7

Test: F34 **Project:** 18559-01 **Date:** August 27, 2021 **Operator:** Deepak

Purpose: Similar to F33, with additional Po Ro Scav, and finer Po regrind

Procedure: As outlined below.

Feed: 2kg LG Comp -10 mesh Freezer\SEC-36E Box 116686

Grind: 42 minutes at 65% solids in 2 kg Rod Mill # 3 P₈₀ =
Regrind: 5 minutes at 50% solids in 2 kg Rod Mill for Cu/Ni R.Conc Cu/Ni 1st CI Feed P₈₀ = N/A Malvern
 15 minutes at 50% solids in 2 kg Attrition Mill for Po 1st CI Po 1st CI Feed P₈₀ = 18.7 µm Malvern

Product	Wet Weigh
Cu/Ni 1st CI Conc	143.4
Cu/Ni 1st CI Sc Conc	24.1
Cu/Ni 1st CI ScTails	135.3
Po 1st CI Conc	23.5
Po 1st CI Sc Conc-1	21.2
Po 1st CI Sc Conc-2	20.1
Po 1st CI ScTails	253.2
Po Ro Conc 1-3	155.3
Po Ro Conc-4	45.4
Po Ro Conc-5	38.3

- Note:**
1. Check Regrind size by Malvern, on the cleaner feed
 2. Assay: Cu, Ni, S, Pt, Pd, Au

Conditions:

Stage	Reagents added, grams per tonne							Time, minutes			pH	ORP, mV
	Lime	DETA	MaxGold 900	PAX	MIBC*	CMC	CuSO4	Grind	Cond.	Froth		
Grind	50		5					42			8.6	261
Cu/Ni Rougher No. 1	70		2.5		0				1	1	9.0	211
Cu/Ni Rougher No. 2	0		2.5	2.5	0				1	2	~9	197
Cu/Ni Rougher No. 3	0		2.5	2.5	5				1	2	~9	196
Po Rougher No. 1	0			10	5				1	3	natural pH	200
Po Rougher No. 2	0			10	5				1	5	natural pH	204
Po Rougher No. 3	0			10	10				1	5	natural pH	210
Po Ro 4				20			50		1	2	8.3	206
Po Ro 5		Mag Sep								4		
Regrind Cu/Ni Ro Conc (2kg Rod Mill)	125	20						5			9.3	188
Cu/Ni 1st Cleaner No.1	5		0	0		30			1	2	9.5	142
Cu/Ni 1st Cleaner No.2	0			1	0				1	2	~	160
Cu/Ni 1st Cleaner Scav	25		2.5	0	0				1	2	9.8	106
Regrind Cu/Ni 1st CI Scav 1 Tails + Po Ro Conc 1-3 (Attrition Mill)	150							15			10.0	140
Po 1st Cleaner	0			4					1	2	10.0	140
Po 1st Cleaner Scav-1	0	10	2.5	0					1	2	~	167
Po 1st Cleaner Scav-2	30 g/t - Na2S								1	1	~	-50
Total	375	30	17.5	60	25	30			13	35		

Keep Cu/Ni and Po separate

Keep Po Ro 4 and Po Ro 5 separate

Target ~40 um
Target 9.5

Target ~15 um
Target 9.5

Stage	Rougher/Scavenger	Po Rougher	Cu/Ni 1st/2nd Cleaner	Po 1st & 2nd CI
Flotation Cell	2 kg float cell	2 kg float cell	500g/250g float cell	250g float cell
Speed: r.p.m.	1800	1800	1500/1200	1200

Metallurgical Balance

Product	Weight		Assays, %											% Distribution									
	g	%	Cu	Ni	S	Other	Pt, g/t	Pd, g/t	Au, g/t	Cp	Pn	Po	Ga	Cu	Ni	S	Pt	Pd	Au	Cp	Pn	Po	Ga
F34 Cu/Ni 1st Cleaner Conc	130.0	6.5	6.79	4.32	34.1	54.8	1.51	8.24	1.03	19.9	11.0	64.2	4.9	83.3	66.5	40.1	45.0	64.3	64.6	83.3	77.9	33.0	0.4
F34 Cu/Ni 1st Cleaner Scav Conc	17.5	0.9	1.79	1.97	31.9	64.3	0.59	2.83	0.23	5.25	4.3	77.3	13.1	3.0	4.1	5.1	2.4	3.0	1.9	3.0	4.1	5.3	0.1
F34 Po 1st Cleaner Conc	16.5	0.8	0.86	1.39	27.0	70.8	0.81	2.30	0.21	2.52	2.9	67.9	26.8	1.3	2.7	4.0	3.1	2.3	1.7	1.3	2.6	4.4	0.3
F34 Po 1st Cleaner Scav Conc-1	14.1	0.7	0.66	1.23	25.9	72.2	0.67	1.90	0.19	1.94	2.5	65.8	29.8	0.9	2.1	3.3	2.2	1.6	1.3	0.9	1.9	3.7	0.2
F34 Po 1st Cleaner Scav Conc-2	13.2	0.7	0.38	0.89	25.7	73.0	0.44	1.23	0.12	1.11	1.50	66.8	30.6	0.5	1.4	3.1	1.3	1.0	0.8	0.5	1.1	3.5	0.2
F34 Po 1st Cleaner Scav Tails	184.8	9.2	0.16	0.41	15.7	83.7	0.16	0.46	0.06	0.47	0.51	41.3	57.7	2.8	9.0	26.3	6.8	5.1	5.3	2.8	5.2	30.2	6.2
F34 Po Ro Conc -4	34.9	1.7	0.17	0.57	21.6	77.7	0.28	0.59	0.06	0.50	0.75	57.0	41.8	0.6	2.4	6.8	2.2	1.2	1.0	0.6	1.4	7.9	0.9
F34 Po Ro Conc -5	27.3	1.4	0.06	0.35	13.5	86.1	0.17	0.42	0.05	0.17	0.42	35.8	63.6	0.1	1.1	3.3	1.1	0.7	0.7	0.1	0.6	3.9	1.0
F34 Po Ro Tails	1573.8	78.2	0.05	0.06	0.56	99.3	0.10	0.22	0.03	0.15	0.06	1.32	98.5	7.6	10.8	8.0	36.0	20.8	22.8	7.6	5.2	8.2	90.7
Head (Calc.)	2012.1	100	0.53	0.42	5.49	93.6	0.22	0.83	0.10	1.54	0.91	12.6	85.0	100	100	100	100	100	100	100	100	100	100
Head (Dir.)			0.55	0.44	5.76	93.3	0.18	0.82	0.07	1.61	0.96	13.2	84.2										

Combined Products

Cu/Ni 1st Cl Conc	130.0	6.5	6.79	4.32	34.1		1.51	8.24	1.03	19.9	11.0	64.2	4.9	83.3	66.5	40.1	45.0	64.3	64.6	83.3	77.9	33.0	0.4
Cu/Ni 1st Cl & Scav Conc	147.5	7.3	6.20	4.04	33.8		1.40	7.60	0.94	18.2	10.2	65.8	5.9	86.2	70.6	45.2	47.3	67.3	66.5	86.2	82.1	38.3	0.5
Po 1st Cl Conc	16.5	0.8	0.86	1.39	27.0		0.81	2.30	0.21	2.5	2.9	67.9	26.8	1.3	2.7	4.0	3.1	2.3	1.7	1.3	2.6	4.4	0.3
Po 1st Cl & Scav Conc 1	30.6	1.5	0.77	1.32	26.5		0.75	2.12	0.20	2.25	2.7	66.9	28.2	2.2	4.8	7.3	5.2	3.9	3.0	2.2	4.5	8.1	0.5
Po 1st Cl & Scav Conc 1-2	43.8	2.2	0.65	1.19	26.3		0.65	1.85	0.18	1.91	2.32	66.9	28.9	2.7	6.2	10.4	6.6	4.9	3.7	2.7	5.5	11.6	0.7
Cu/Ni 1st Cl Tails & Po Ro Conc 1-3	228.6	11.4	0.25	0.56	17.7		0.25	0.73	0.08	0.75	0.86	46.2	52.2	5.5	15.1	36.7	13.3	10.0	9.1	5.5	10.7	41.8	7.0
Cu/Ni Ro Conc 1-3 & Po Ro Conc 1-3	376.1	18.7	2.58	1.92	24.0		0.70	3.42	0.42	7.58	4.52	53.9	34.0	91.7	85.7	81.9	60.7	77.3	75.6	91.7	92.8	80.1	7.5
Cu/Ni Ro Conc 1-3 & Po Ro Conc 1-5	438.3	21.8	2.24	1.72	23.2		0.64	3.01	0.37	6.55	3.96	53.0	36.5	92.4	89.2	92.0	64.0	79.2	77.2	92.4	94.8	91.8	9.3

Test: F35 **Project:** 18559-01 **Date:** August 27, 2021 **Operator:** Deepak

Purpose: Similar to F33, with additional Po Ro Scav, and finer Po regrind

Procedure: As outlined below.

Feed: 2kg LG Comp -10 mesh Freezer\SEC-36E Box 116686

Grind: 42 minutes at 65% solids in 2 kg Rod Mill # 3 P₈₀ =
Regrind: 10 minutes at 50% solids in 2 kg Rod Mill for Cu/Ni R.Conc Cu/Ni 1st CI Feed P₈₀ = 30 µm Malvern
 15 minutes at 50% solids in 2 kg Attrition Mill for Po 1st CI Po 1st CI Scav Tails P₈₀ = 23 µm Malvern

Product	Wet Weigh
Cu/Ni 1st CI Conc	79.4
Cu/Ni 1st CI Sc Conc	8.6
Cu/Ni 1st CI ScTails	156.1
Po 1st CI Conc	37.2
Po 1st CI Sc Conc	34.2
Po 1st CI ScTails	355.4
Po Ro Conc	235.9

- Note:**
1. Check Regrind size by Malvern, on the cleaner feed
 2. Assay: Cu, Ni, S, Pt, Pd, Au

Conditions:

Stage	Reagents added, grams per tonne							Time, minutes			pH	ORP, mV
	Lime	DETA	MaxGold 900	PAX	MIBC*	CMC	CuSO4	Grind	Cond.	Froth		
Grind	50		5					42			8.8	148
Cu/Ni Rougher No. 1	30		2.5		0				1	1	9.0	162
Cu/Ni Rougher No. 2	0		2.5	2.5	5				1	2	~9	174
Cu/Ni Rougher No. 3	0		2.5	2.5	5				1	2	~9	175
Po Rougher No. 1	0			20	0				1	3	natural pH	180
Po Rougher No. 2	0			20	5				1	3	natural pH	185
Po Rougher No. 3	0			20	10		50		1	3	natural pH	185
Regrind Cu/Ni Ro Conc (2kg Rod Mill)	125	20						10			9.2	172
Cu/Ni 1st Cleaner No.1	60		0	0		30			1	2	9.5	135
Cu/Ni 1st Cleaner No.2	0			1	7.5				1	2	~	153
Cu/Ni 1st Cleaner Scav	40		2.5	0	2.5				1	2	9.5	127
Regrind Cu/Ni 1st CI Scav 1 Tails + Po Ro Conc 1-3 (Attrition Mill)	150							15			9.5	154
Po 1st Cleaner	0			2		40			1	2	9.5	154
Po 1st Cleaner Scav	0		2.5	0					1	2	~	171
Total	405	20	17.5	68	35	70			11	24		

Keep Cu/Ni and Po separate

Target ~40 um
Target 9.5

Target ~15 um
Target 9.5

Stage	Rougher/Scavenger	Po Rougher	Cu/Ni 1st/2nd Cleaner	Po 1st & 2nd CI
Flotation Cell	2 kg float cell	2 kg float cell	500g/250g float cell	250g float cell
Speed: r.p.m.	1800	1800	1500/1200	1200

Metallurgical Balance

Product	Weight		Assays, %											% Distribution									
	g	%	Cu	Ni	S	Other	Pt, g/t	Pd, g/t	Au, g/t	Cp	Pn	Po	Ga	Cu	Ni	S	Pt	Pd	Au	Cp	Pn	Po	Ga
F35 Cu/Ni 1st Cleaner Conc	67.6	3.4	12.7	7.05	33.8	46.5	2.73	15.9	2.47	37.2	18.8	41.0	3.0	78.5	55.0	20.2	43.7	63.0	66.0	78.5	67.5	10.7	0.1
F35 Cu/Ni 1st Cleaner Scav Conc	5.6	0.3	3.36	4.97	32.3	59.4	1.26	5.19	0.51	9.85	12.7	67.1	10.3	1.7	3.2	1.6	1.7	1.7	1.1	1.7	3.8	1.5	0.0
F35 Po 1st Cleaner Conc	26.1	1.3	1.52	2.77	32.9	62.8	1.54	4.00	0.44	4.46	6.5	78.9	10.2	3.6	8.3	7.6	9.5	6.1	4.5	3.6	9.0	8.0	0.2
F35 Po 1st Cleaner Scav Conc	25.4	1.3	0.81	1.77	33.2	64.2	0.63	1.88	0.18	2.38	3.7	83.9	9.97	1.9	5.2	7.5	3.8	2.8	1.8	1.9	5.0	8.2	0.1
F35 Po 1st Cleaner Scav Tails	260.2	12.9	0.20	0.50	19.0	80.3	0.17	0.48	0.07	0.59	0.65	50.0	48.8	4.8	15.0	43.8	10.5	7.3	7.2	4.8	8.9	50.3	7.4
F35 Po Ro Tails	1630.9	80.9	0.06	0.07	1.34	98.5	0.08	0.20	0.03	0.19	0.07	3.4	96.4	9.5	13.2	19.3	30.9	19.1	19.3	9.5	5.8	21.3	92.1
Head (Calc.)	2015.8	100	0.54	0.43	5.60	93.4	0.21	0.85	0.13	1.59	0.93	12.8	84.7	100	100	100	100	100	100	100	100	100	100
Head (Dir.)			0.55	0.44	5.76	93.3	0.18	0.82	0.07	1.61	0.96	13.2	84.2										

Combined Products

Cu/Ni 1st Cl Conc	67.6	3.4	12.7	7.05	33.8		2.7	15.9	2.5	37.2	18.8	41.0	3.0	78.5	55.0	20.2	43.7	63.0	66.0	78.5	67.5	10.7	0.1
Cu/Ni 1st Cl & Scav Conc	73.2	3.6	12.0	6.89	33.7		2.6	15.1	2.3	35.1	18.3	43.0	3.5	80.2	58.3	21.8	45.3	64.7	67.1	80.2	71.3	12.2	0.2
Po 1st Cl Conc	26.1	1.3	1.52	2.77	32.9		1.5	4.00	0.4	4.5	6.5	78.9	10.2	3.6	8.3	7.6	9.5	6.1	4.5	3.6	9.0	8.0	0.2
Po 1st Cl & Scav Conc	51.5	2.6	1.17	2.28	33.0		1.09	2.95	0.31	3.43	5.1	81.4	10.1	5.5	13.5	15.1	13.3	8.9	6.3	5.5	14.0	16.2	0.3
Cu/Ni 1st Cl Tails & Po Ro Conc 1-3	311.7	15.5	0.36	0.79	21.3		0.32	0.89	0.11	1.06	1.39	55.2	42.4	10.3	28.6	58.8	23.8	16.2	13.5	10.3	23.0	66.5	7.7
Cu/Ni Ro Conc 1-3 & Po Ro Conc 1-3	384.9	19.1	2.57	1.95	23.7		0.76	3.59	0.53	7.54	4.61	52.9	35.0	90.5	86.8	80.7	69.1	80.9	80.7	90.5	94.2	78.7	7.9

Test: F36 **Project:** 18559-01 **Date:** August 31, 2021 **Operator:** Deepak

Purpose: Similar to F35, with no DETA, CuSep

Procedure: As outlined below.

Feed: 2kg LG Comp -10 mesh Freezer\SEC-36E Box 116686

Grind: 42 minutes at 65% solids in 2 kg Rod Mill # 3 P₈₀ =
Regrind 10 minutes at 50% solids in 2 kg Rod Mill for Cu/Ni R.Conc Cu/Ni 1st Cl Feed P₈₀ = 30 µm Malvern
 15 minutes at 50% solids in 2 kg Attrition Mill for Po 1st Cl Po 1st Cl Scav Tails P₈₀ = N/A Malvern

Note: 1. Assay: Cu, Ni, S, Pt, Pd, Au

Conditions:

Stage	Reagents added, grams per tonne							Time, minutes			pH	ORP, mV
	Lime	DETA	MaxGold 900	PAX	MIBC*	CMC	CuSO4	Grind	Cond.	Froth		
Grind	50		5					42			8.8	233
Cu/Ni Rougher No. 1	25		2.5		0				1	1	9.0	195
Cu/Ni Rougher No. 2	0		2.5	2.5	0				1	2	~9	193
Cu/Ni Rougher No. 3	0		2.5	2.5	5				1	2	~9	198
Po Rougher No. 1	0			20	5				1	3	natural pH	189
Po Rougher No. 2	0			20	5				1	3	natural pH	187
Po Rougher No. 3	0			20	5		50		1	3	natural pH	193
Regrind Cu/Ni Ro Conc (2kg Rod Mill)	125	0						10			9.4	179
Cu/Ni 1st Cleaner No.1	15		0	0		30			1	2	9.5	139
Cu/Ni 1st Cleaner No.2	0			1	0				1	2	~	157
Cu/Ni 1st Cleaner Scav	15		2.5	0	0				1	2	9.5	136
Regrind Cu/Ni 1st Cl Scav 1 Tails + Po Ro Conc 1-3 (Attrition Mill)												
	150							15			10.0	123
Po 1st Cleaner	0			2		40			1	2	10.0	123
Po 1st Cleaner Scav	0		2.5	0					1	1	~	139
Po 2nd Cleaner	100		2.5	0		0			1	2	11.0	44
CuSEP												
Polish Grind (Pepple mill)	325							2.5			11.6	20
Cu Ro 1	0			0	0				1	2	11.6	20
Cu Ro 2	0			1	0				1	2	11.6	16
Cu Ro Scav	0			0	0				1	1	11.5	18
Cu 1st Cl	100				0				1	3	11.5	12
Cu 2nd Cl	130				0				1	2	11.5	15
Total	430	0	20	68	20	70			12	25		

Keep Cu/Ni and Po separate

Target ~30 um

Target 9.5

Target ~15 um

Target 9.5

pH probe broke. Overshot the lime.

Stage	Rougher/Scavenger	Po Rougher	Cu/Ni 1st/2nd Cleaner	Po 1st & 2nd Cl
Flotation Cell	2 kg float cell	2 kg float cell	500g/250g float cell	250g float cell
Speed: r.p.m.	1800	1800	1500/1200	1200

Metallurgical Balance

Product	Weight		Assays, %											% Distribution									
	g	%	Cu	Ni	S	Other	Pt, g/t	Pd, g/t	Au, g/t	Cp	Pn	Po	Ga	Cu	Ni	S	Pt	Pd	Au	Cp	Pn	Po	Ga
F36 Cu 2nd Cleaner Conc	14.8	0.7	30.7	1.67	34.4	33.2	4.03	34.6	4.03	90.0	4.5	6.6	-1.15	44.2	2.9	4.6	14.5	31.7	21.9	44.2	3.6	0.4	0.0
F36 Cu 2nd Cleaner Tails	6.9	0.3	20.3	7.40	32.4	39.9	3.58	23.2	7.27	59.5	20.1	15.8	4.54	13.6	6.0	2.0	6.0	9.9	18.4	13.6	7.4	0.4	0.0
F36 Cu 1st Cleaner Tails	12.5	0.6	10.1	9.10	31.9	48.9	2.98	13.4	2.03	29.6	24.5	38.0	7.87	12.3	13.3	3.6	9.1	10.4	9.3	12.3	16.4	1.9	0.1
F36 Cu Ro Scav Conc	4.0	0.2	12.2	9.07	32.4	46.3	3.46	15.1	6.57	35.8	24.4	33.8	5.98	4.7	4.2	1.2	3.4	3.7	9.7	4.7	5.2	0.5	0.0
F36 Cu Ro Scav Tails	60.7	3.0	1.71	5.11	32.8	60.4	1.24	3.1	0.31	5.01	13.0	72.6	9.39	10.1	36.2	18.1	18.3	11.6	6.9	10.1	42.4	17.4	0.3
F36 Cu/Ni 1st Cleaner Scav Conc	13.2	0.7	0.82	1.98	33.3	63.9	0.56	2.0	0.21	2.40	4.28	83.7	9.61	1.1	3.0	4.0	1.8	1.6	1.0	1.1	3.0	4.4	0.1
F36 Po 2nd Cleaner Conc	10.0	0.5	1.72	3.19	35.1	60.0	2.16	5.6	0.55	5.04	7.62	83.3	4.03	1.7	3.7	3.2	5.3	3.5	2.0	1.7	4.1	3.3	0.0
F36 Po 2nd Cleaner Tails	31.6	1.6	0.44	1.25	30.6	67.7	0.50	1.3	0.13	1.29	2.33	79.1	17.3	1.4	4.6	8.8	3.8	2.6	1.5	1.4	3.9	9.9	0.3
F36 Po 1st Cleaner Scav Conc	22.8	1.1	0.42	1.21	31.2	67.2	0.40	1.2	0.13	1.23	2.20	80.9	15.7	0.9	3.2	6.5	2.2	1.7	1.1	0.9	2.7	7.3	0.2
F36 Po 1st Cleaner Scav Tails	288.7	14.3	0.13	0.38	15.3	84.2	0.13	0.3	0.05	0.38	0.44	40.4	58.8	3.6	12.8	40.1	9.1	6.1	5.3	3.6	6.8	46.1	9.9
F36 Po Ro Tails	1552.4	76.9	0.04	0.06	0.6	99.3	0.07	0.2	0.04	0.13	0.05	1.37	98.4	6.5	10.1	8.0	26.5	17.3	22.8	6.5	4.5	8.4	89.1
Head (Calc.)	2017.6	100	0.51	0.43	5.46	93.6	0.20	0.80	0.13	1.50	0.93	12.5	85.0	100	100	100	100	100	100	100	100	100	100
Head (Dir.)			0.55	0.44	5.76	93.3	0.18	0.82	0.07	1.61	0.96	13.2	84.2										

Combined Products

Cu 2nd Cleaner Conc	14.8	0.7	30.7	1.67	34.4		4.03	34.6	4.03	90.0	4.50	6.62	-1.1	44.2	2.9	4.6	14.5	31.7	21.9	44.2	3.6	0.4	0.0
Cu 1st Cleaner Conc	21.7	1.1	27.4	3.49	33.8		3.89	31.0	5.06	80.3	9.46	9.55	0.66	57.8	8.8	6.6	20.5	41.6	40.3	57.8	11.0	0.8	0.0
Cu Ro Conc	34.2	1.7	21.1	5.54	33.1		3.56	24.6	3.95	61.8	14.9	20.0	3.30	70.0	22.1	10.3	29.6	52.0	49.7	70.0	27.4	2.7	0.1
Cu Ro & Scav Conc	38.2	1.9	20.1	5.91	33.0		3.55	23.6	4.23	59.1	15.9	21.4	3.58	74.8	26.3	11.4	33.0	55.7	59.3	74.8	32.6	3.2	0.1
Cu/Ni 1st Cl Conc	98.9	4.9	8.83	5.42	32.9		2.13	11.0	1.82	25.9	14.2	52.8	7.14	84.9	62.5	29.5	51.3	67.3	66.2	84.9	75.0	20.6	0.4
Cu/Ni 1st Cl & Scav Conc	112.1	5.6	7.89	5.01	32.9		1.95	9.93	1.63	23.1	13.0	56.4	7.43	85.9	65.5	33.5	53.1	68.9	67.3	85.9	78.0	25.0	0.5
Po 2nd Cl Conc	10.0	0.5	1.72	3.19	35.1		2.16	5.59	0.55	5.04	7.62	83.3	4.03	1.7	3.7	3.2	5.3	3.5	2.0	1.7	4.1	3.3	0.0
Po 1st Cl Conc	41.6	2.1	0.75	1.72	31.7		0.90	2.36	0.23	2.19	3.60	80.1	14.1	3.0	8.3	12.0	9.1	6.1	3.5	3.0	8.0	13.2	0.3
Po 1st Cl & Scav Conc	64.4	3.2	0.63	1.54	31.5		0.72	1.95	0.20	1.85	3.11	80.4	14.7	4.0	11.5	18.4	11.3	7.8	4.6	4.0	10.7	20.5	0.5
Cu/Ni 1st Cl Tails & Po Ro Conc 1-3	353.1	17.5	0.22	0.59	18.3		0.24	0.63	0.08	0.65	0.93	47.7	50.7	7.6	24.3	58.5	20.5	13.8	9.9	7.6	17.5	66.6	10.4
Cu/Ni Ro Conc 1-3 & Po Ro Conc 1-3	465.2	23.1	2.07	1.66	21.8		0.65	2.87	0.45	6.07	3.83	49.8	40.3	93.5	89.9	92.0	73.5	82.7	77.2	93.5	95.5	91.6	10.9

Test: F38 Project: 18559-01 Date: September 2, 2021 Operator: Deepak

Purpose: Similar to F36, with HG Comp

Procedure: As outlined below.

Feed: 2kg HG Comp -10 mesh Freezer\SEC-19E Box 116703/116702

Grind: 34 minutes at 65% solids in 2 kg Rod Mill # 3 P₈₀ =
 Regrind: 15 minutes at 50% solids in 2 kg Rod Mill for Cu/Ni R.Conc Cu/Ni 1st Cl Feed P₈₀ = 28.6 µm Malvern
 18 minutes at 50% solids in 2 kg Attrition Mill for Po 1st Cl Po 1st Cl Feed P₈₀ = 26.5 µm Malvern

Note: 1. Assay: Cu, Ni, S, Pt, Pd, Au

Conditions:

Stage	Reagents added, grams per tonne							Time, minutes			pH	ORP, mV	
	Lime	DETA	MaxGold 900	PAX	MIBC*	CMC	CuSO4	Grind	Cond.	Froth			
Grind	50		5					34			8.7	158	
Cu/Ni Rougher No. 1	25		2.5		0				1	1	9.0	98	
Cu/Ni Rougher No. 2	0		2.5	2.5	0				1	2	~9	165	
Cu/Ni Rougher No. 3	0		2.5	2.5	5				1	2	~9	184	Keep Cu/Ni and Po separate
Po Rougher No. 1	0			20	5				1	3	natural pH	186	
Po Rougher No. 2	0			20	5				1	3	natural pH	193	
Po Rougher No. 3	0			20	5		50		1	3	natural pH	207	
Po Rougher Scav	0			30			50		1	3+1	natural pH	228	
Regrind Cu/Ni Ro Conc (2kg Rod Mill)	175	0						15			9.3	145	Target ~30 um
Cu/Ni 1st Cleaner No.1	10		0	0		30			1	2	9.5	128	Target 9.5
Cu/Ni 1st Cleaner No.2	0			1	0				1	2	~	182	
Cu/Ni 1st Cleaner Scav	25		2.5	1	0				1	2	9.5	163	
Regrind Cu/Ni 1st Cl Scav 1 Tails + Po Ro Conc 1-3 (Attrition Mill)													Target ~15 um
	150							18			9.6	171	
Po 1st Cleaner	0			1		40			1	2	~	171	
Po 1st Cleaner Scav	0		2.5	0					1	1	~	183	
Po 2nd Cleaner	0		0	0		0			1	2	~	183	
CuSEP													
Polish Grind (Pepple mill)	400							4			11.7	17	
Cu Ro 1	0			0	0				1	2	11.7	17	
Cu Ro 2	0			1	0				1	2	11.7	43	
Cu Ro Scav	0			1	0				1	1	11.6	47	
Cu 1st Cl	60				0				1	3	11.5	58	
Cu 2nd Cl	60				0				1	2	11.5	77	
Total	385	0	17.5	98	20	70			13	25			

Stage	Rougher/Scavenger	Po Rougher	Cu/Ni 1st/2nd Cleaner	Po 1st & 2nd Cl
Flotation Cell	2 kg float cell	2 kg float cell	500g/250g float cell	250g float cell
Speed: r.p.m.	1800	1800	1500/1200	1200

Metallurgical Balance

Product	Weight		Assays, %											% Distribution									
	g	%	Cu	Ni	S	Other	Pt, g/t	Pd, g/t	Au, g/t	Cp	Pn	Po	Ga	Cu	Ni	S	Pt	Pd	Au	Cp	Pn	Po	Ga
F38 Cu 2nd Cleaner Conc	22.4	1.1	28.7	3.29	34.7	33.3	3.76	51.4	4.14	84.2	8.9	9.0	-2.11	48.7	5.0	3.9	13.2	42.6	31.8	48.7	6.2	0.4	0.0
F38 Cu 2nd Cleaner Tails	7.9	0.4	14.5	9.75	33.6	42.2	3.55	22.7	2.99	42.5	26.4	29.2	1.86	8.7	5.3	1.3	4.4	6.6	8.1	8.7	6.4	0.5	0.0
F38 Cu 1st Cleaner Tails	15.8	0.8	8.68	9.76	33.4	48.2	2.98	15.0	3.12	25.5	26.2	44.4	3.94	10.4	10.6	2.7	7.4	8.8	16.9	10.4	12.8	1.5	0.0
F38 Cu Ro Scav Conc	7.9	0.4	9.30	9.37	34.6	46.7	3.24	15.1	1.60	27.3	25.1	46.9	0.72	5.6	5.1	1.4	4.0	4.4	4.3	5.6	6.1	0.8	0.0
F38 Cu Ro Scav Tails	80.0	4.0	1.84	6.20	34.3	57.7	1.81	3.7	0.28	5.40	16.0	73.7	4.86	11.2	33.9	13.8	22.7	10.9	7.7	11.2	39.5	12.5	0.3
F38 Cu/Ni 1st Cleaner Scav Conc	21.7	1.1	1.17	2.81	34.8	61.2	0.72	2.7	0.26	3.43	6.55	84.9	5.14	1.9	4.2	3.8	2.5	2.1	1.9	1.9	4.4	3.9	0.1
F38 Po 2nd Cleaner Conc	25.2	1.3	0.65	2.66	36.8	59.9	1.88	2.9	1.16	1.91	6.04	92.1	-0.02	1.2	4.6	4.7	7.4	2.7	10.0	1.2	4.7	4.9	0.0
F38 Po 2nd Cleaner Tails	31.6	1.6	0.37	1.52	32.3	65.8	0.61	1.2	0.10	1.09	3.02	83.3	12.6	0.9	3.3	5.1	3.0	1.3	1.1	0.9	2.9	5.6	0.3
F38 Po 1st Cleaner Scav Conc	39.0	1.9	0.27	1.37	34.1	64.3	0.48	0.8	0.08	0.79	2.54	88.8	7.9	0.8	3.7	6.7	2.9	1.2	1.1	0.8	3.0	7.3	0.2
F38 Po 1st Cleaner Scav Tails	399.7	19.9	0.13	0.60	23.6	75.7	0.18	0.4	0.05	0.38	0.76	62.4	36.4	3.9	16.4	47.4	11.3	5.6	6.9	3.9	9.4	52.9	9.9
F38 Po Ro Scav Conc	62.9	3.1	0.24	0.50	13.2	86.1	0.28	0.8	0.06	0.70	0.85	34.1	64.3	1.1	2.2	4.2	2.8	1.8	1.3	1.1	1.7	4.5	2.8
F38 Po Ro Tails	1292.7	64.4	0.06	0.07	0.78	99.1	0.09	0.3	0.02	0.17	0.07	1.88	97.9	5.6	5.8	5.1	18.3	11.9	8.9	5.6	3.0	5.2	86.4
Head (Calc.)	2006.8	100	0.66	0.73	9.91	88.7	0.32	1.35	0.15	1.93	1.62	23.5	72.9	100	100	100	100	100	100	100	100	100	100
Head (Dir.)			0.66	0.77	10.5	88.1	0.37	1.28	0.08	1.94	1.71	25.0	71.3										

Combined Products

Cu 2nd Cleaner Conc	22.4	1.1	28.7	3.29	34.7		3.76	51.4	4.14	84.2	8.92	9.03	-2.1	48.7	5.0	3.9	13.2	42.6	31.8	48.7	6.2	0.4	0.0
Cu 1st Cleaner Conc	30.3	1.5	25.0	4.97	34.4		3.71	43.9	3.84	73.3	13.5	14.3	-1.08	57.4	10.3	5.2	17.6	49.2	39.9	57.4	12.6	0.9	0.0
Cu Ro Conc	46.1	2.3	19.4	6.61	34.1		3.46	34.0	3.59	56.9	17.8	24.6	0.64	67.8	20.9	7.9	25.0	57.9	56.8	67.8	25.3	2.4	0.0
Cu Ro & Scav Conc	54.0	2.7	17.9	7.02	34.1		3.42	31.2	3.30	52.6	18.9	27.9	0.66	73.3	25.9	9.3	29.1	62.4	61.2	73.3	31.4	3.2	0.0
Cu/Ni 1st Cl Conc	134.0	6.7	8.32	6.53	34.2		2.46	14.8	1.50	24.4	17.2	55.2	3.17	84.5	59.9	23.1	51.8	73.3	68.9	84.5	70.9	15.7	0.3
Cu/Ni 1st Cl & Scav Conc	155.7	7.8	7.33	6.01	34.3		2.22	13.1	1.33	21.5	15.7	59.4	3.44	86.4	64.1	26.9	54.2	75.4	70.8	86.4	75.3	19.6	0.4
Po 2nd Cl Conc	25.2	1.3	0.65	2.66	36.8		1.88	2.86	1.16	1.91	6.04	92.1	-0.02	1.2	4.6	4.7	7.4	2.7	10.0	1.2	4.7	4.9	0.0
Po 1st Cl Conc	56.8	2.8	0.49	2.03	34.3		1.17	1.91	0.57	1.45	4.36	87.2	7.01	2.1	7.9	9.8	10.5	4.0	11.1	2.1	7.6	10.5	0.3
Po 1st Cl & Scav Conc	95.8	4.8	0.40	1.76	34.2		0.89	1.47	0.37	1.18	3.62	87.8	7.36	2.9	11.5	16.5	13.4	5.2	12.2	2.9	10.7	17.8	0.5
Cu/Ni 1st Cl Tails & Po Ro Conc 1-3	495.5	24.7	0.18	0.82	25.7		0.32	0.59	0.11	0.54	1.31	67.4	30.8	6.9	27.9	63.9	24.7	10.8	19.0	6.9	20.1	70.7	10.4
Cu/Ni Ro Conc 1-3 & Po Ro Conc 1-3	651.2	32.4	1.89	2.06	27.7		0.77	3.58	0.40	5.54	4.75	65.5	24.3	93.3	92.0	90.8	79.0	86.2	89.8	93.3	95.4	90.3	10.8

Test: F40 **Project:** 18559-01 **Date:** September 20, 2021 **Operator:** Deepak

Purpose: Similar to LCT-4, using HG Comp

Procedure: As outlined below.

Feed: 2kg HG Comp -10 mesh Freezer\SEC-19E Box 116703/116702

Grind: 34 minutes at 65% solids in 2 kg Rod Mill # 3 P₈₀ =
Regrind 15 minutes at 50% solids in 2 kg Rod Mill for Cu/Ni R.Conc Cu/Ni 1st Cl Feed P₈₀ = Malvern
 25 minutes at 50% solids in 2 kg Attrition Mill for Po 1st Cl Po 1st Cl Feed P₈₀ = Malvern

Note: 1. Assay: Cu, Ni, S, Pt, Pd, Au

Conditions:

Stage	Reagents added, grams per tonne							Time, minutes			pH	ORP, mV	
	Lime	DETA	MaxGold 900	PAX	MIBC*	CMC	CuSO4	Grind	Cond.	Froth			
Grind	100		5					34			8.7	210	
Cu/Ni Rougher No. 1	20				0				1	1	9.0	179	
Cu/Ni Rougher No. 2	0			5	0				1	2	~9	182	
Cu/Ni Rougher No. 3	0			5	5				1	2	~9	189	Keep Cu/Ni and Po separate
Po Rougher No. 1	0			10	5				1	3	natural pH	193	
Po Rougher No. 2	0			10	5				1	4	natural pH	200	
Po Rougher No. 3	0			10	5				1	4	natural pH	207	
Po Rougher Scav	0			30			50		1	4	natural pH	215	
Regrind Cu/Ni Ro Conc (2kg Rod Mill)	175	0						15			9.1	176	Target ~30 um
Cu/Ni 1st Cleaner No.1	20			0		30			1	2	9.5	153	
Cu/Ni 1st Cleaner No.2	0			1	0				1	2	~	176	
Cu/Ni 1st Cleaner Scav	30			2	0				1	2	9.5	153	
Regrind Cu/Ni 1st Cl Scav 1 Tails + Po Ro Conc 1-3 (Attrition Mill)													Target ~15 um
	100							25			9.3	127	
Po 1st Cleaner -1	0			2		40			1	2	~	78	
Po 1st Cleaner -2	0			1					1	1	~	191	
Po 2nd Cleaner	0			1		0			1	2	~	187	
Po 3rd Cleaner-1	0			0		0			1	2	~	202	
Po 3rd Cleaner-2				0.5					1	0.5	~	~	
CuSEP													
Polish Grind (Pepple mill)	400							4			11.6	45	
Cu Ro 1	0			0	0				1	2	11.6	45	
Cu Ro 2	0			0.5	0				1	2	11.6	31	
Cu Ro Scav	0			0.5	0				1	1	11.6	29	
Cu 1st Cl	80				0				1	3	11.5	39	
Cu 2nd Cl	85				0				1	2	11.5	59	
Cu 3rd Cl	90				0				1	2	11.5	64	
Total	345	0	5	77.5	20	70			15	33.5			

Stage	Rougher/Scavenger	Po Rougher	Cu/Ni 1st/2nd Cleaner	Po 1st & 2nd Cl
Flotation Cell	2 kg float cell	2 kg float cell	500g/250g float cell	250g float cell
Speed: r.p.m.	1800	1800	1500/1200	1200

Metallurgical Balance

Product	Weight		Assays, %											% Distribution									
	g	%	Cu	Ni	S	Other	Pt, g/t	Pd, g/t	Au, g/t	Cp	Pn	Po	Ga	Cu	Ni	S	Pt	Pd	Au	Cp	Pn	Po	Ga
F40 Cu 3rd Cleaner Conc	12.5	0.6	33.0	0.42	34.6	32.0	2.51	60.8	4.53	96.8	1.10	3.89	-1.76	31.8	0.3	2.1	4.6	28.6	13.3	31.8	0.4	0.1	0.0
F40 Cu 3rd Cleaner Tails	6.1	0.3	30.0	1.77	33.3	34.9	3.84	47.7	13.5	88.0	4.79	5.29	1.95	14.1	0.7	1.0	3.4	10.9	19.4	14.1	0.9	0.1	0.0
F40 Cu 2nd Cleaner Tails	4.5	0.2	22.4	5.57	32.0	40.0	4.30	32.9	7.92	65.7	15.1	13.4	5.84	7.8	1.7	0.7	2.8	5.6	8.4	7.8	2.0	0.1	0.0
F40 Cu 1st Cleaner Tails	9.6	0.5	10.2	9.01	33.5	47.3	3.67	17.4	7.10	29.9	24.2	42.3	3.59	7.5	5.8	1.6	5.1	6.3	16.1	7.5	7.0	0.8	0.0
F40 Cu Ro Scav Conc	5.4	0.3	14.0	8.30	34.8	42.9	3.83	21.0	5.16	41.1	22.3	37.3	-0.61	5.8	3.0	0.9	3.0	4.3	6.6	5.8	3.6	0.4	0.0
F40 Cu Ro Scav Tails	91.7	4.5	2.22	7.58	35.2	55.0	2.28	4.42	0.66	6.51	19.8	71.9	1.76	15.7	46.3	15.7	30.5	15.3	14.3	15.7	54.6	13.5	0.1
F40 Cu/Ni 1st Cleaner Scav Conc	17.0	0.8	1.14	3.28	36.1	59.5	1.07	2.44	0.45	3.34	7.81	87.4	1.46	1.5	3.7	3.0	2.7	1.6	1.8	1.5	4.0	3.0	0.0
F40 Po 3rd Cleaner Conc-1	22.7	1.1	1.51	3.99	37.3	57.2	2.68	4.37	0.47	4.43	9.75	88.0	-2.2	2.6	6.0	4.1	8.9	3.7	2.5	2.6	6.7	4.1	0.0
F40 Po 3rd Cleaner Conc-2	4.4	0.2	0.65	2.30	38.3	58.8	1.19	1.84	0.67	1.91	4.99	97.0	-3.9	0.2	0.7	0.8	0.8	0.3	0.7	0.2	0.7	0.9	0.0
F40 Po 3rd Cleaner Tails	13.0	0.6	0.30	1.12	34.6	64.0	0.33	0.86	0.10	0.88	1.83	90.7	6.6	0.3	1.0	2.2	0.6	0.4	0.3	0.3	0.7	2.4	0.1
F40 Po 2nd Cleaner Tails	43.2	2.1	0.23	0.99	29.0	69.8	0.24	0.68	0.08	0.67	1.66	75.9	21.7	0.8	2.9	6.1	1.5	1.1	0.8	0.8	2.2	6.7	0.6
F40 Po 1st Cleaner Tails	354.9	17.6	0.19	0.69	23.9	75.2	0.25	0.51	0.06	0.56	1.00	62.9	35.5	5.2	16.3	41.3	13.0	6.8	5.0	5.2	10.7	45.6	8.7
F40 Po Ro Scav Conc	153.1	7.6	0.14	0.56	21.3	78.0	0.28	0.62	0.05	0.41	0.73	56.3	42.6	1.7	5.7	15.9	6.3	3.6	1.8	1.7	3.4	17.6	4.5
F40 Po Ro Tails	1280.2	63.4	0.05	0.07	0.74	99.1	0.09	0.24	0.03	0.15	0.08	1.78	98.0	5.0	5.9	4.6	16.8	11.6	9.0	5.0	3.2	4.7	86.1
Head (Calc.)	2018.3	100	0.64	0.74	10.2	88.4	0.34	1.32	0.21	1.89	1.65	24.2	72.2	100	100	100	100	100	100	100	100	100	100
Head (Dir.)			0.66	0.77	10.5	88.1	0.37	1.28	0.08	1.94	1.71	25.0	71.3										

Combined Products

Cu 3rd Cleaner Conc	12.5	0.6	33.0	0.42	34.6		2.51	60.8	4.53	96.8	1.10	3.89	-1.8	31.8	0.3	2.1	4.6	28.6	13.3	31.8	0.4	0.1	0.0
Cu 2nd Cleaner Conc	18.6	0.9	32.0	0.86	34.2		2.95	56.5	7.47	93.9	2.31	4.35	-0.5	45.9	1.1	3.1	8.0	39.6	32.7	45.9	1.3	0.2	0.0
Cu 1st Cleaner Conc	23.1	1.1	30.1	1.78	33.8		3.21	51.9	7.56	88.4	4.80	6.10	0.70	53.6	2.7	3.8	10.8	45.1	41.1	53.6	3.3	0.3	0.0
Cu Ro Conc	32.7	1.6	24.3	3.90	33.7		3.34	41.8	7.42	71.2	10.5	16.7	1.55	61.2	8.5	5.4	16.0	51.4	57.2	61.2	10.3	1.1	0.0
Cu Ro & Scav Conc	38.1	1.9	22.8	4.53	33.8		3.41	38.8	7.10	66.9	12.2	19.6	1.24	67.0	11.5	6.3	19.0	55.7	63.7	67.0	13.9	1.5	0.0
Cu/Ni 1st Cl Conc	129.8	6.4	8.27	6.68	34.8		2.61	14.5	2.55	24.3	17.6	56.6	1.61	82.7	57.8	22.0	49.5	70.9	78.0	82.7	68.5	15.0	0.1
Cu/Ni 1st Cl & Scav Conc	146.8	7.3	7.44	6.29	35.0		2.43	13.1	2.31	21.8	16.5	60.1	1.59	84.2	61.5	25.0	52.2	72.5	79.8	84.2	72.5	18.0	0.2
Po 3rd Cl Conc-1	22.7	1.1	1.51	3.99	37.3		2.68	4.37	0.47	4.43	9.75	88.0	-2.16	2.6	6.0	4.1	8.9	3.7	2.5	2.6	6.7	4.1	0.0
Po 3rd Cl Conc - 1 & 2	27.1	1.3	1.37	3.72	37.5		2.44	3.96	0.50	4.02	8.98	89.4	-2.44	2.9	6.7	4.9	9.6	4.0	3.2	2.9	7.3	5.0	0.0
Po 2nd Cl Conc	40.1	2.0	1.02	2.87	36.5		1.75	2.95	0.37	3.00	6.66	89.8	0.50	3.2	7.7	7.1	10.3	4.5	3.5	3.2	8.0	7.4	0.0
Po 1st Cl Conc	83.3	4.1	0.61	1.90	32.6		0.97	1.77	0.22	1.79	4.07	82.6	11.5	3.9	10.5	13.2	11.8	5.6	4.3	3.9	10.2	14.1	0.7
Cu/Ni 1st Cl Tails & Po Ro Conc 1-3	438.2	21.7	0.27	0.92	25.6		0.39	0.75	0.09	0.79	1.59	66.6	31.0	9.1	26.9	54.5	24.7	12.4	9.3	9.1	20.9	59.7	9.3
Cu/Ni Ro Conc 1-3 & Po Ro Conc 1-3	585.0	29.0	2.07	2.27	27.9		0.90	3.85	0.65	6.07	5.32	65.0	23.6	93.3	88.4	79.5	76.9	84.9	89.2	93.3	93.4	77.7	9.5

Test: LCT-4 **Project:** 18559-01 **Date:** 09-13-2021 **Operator:** Deepak, Marteen
Purpose: Based on F-35, F24, no DETA

Feed: 2kg LG Comp -10 mesh Freezer/SEC-36E Box 116686

Grind: 42 minutes at 65% solids in 2 kg Rod Mill # 3 Cycle A

Regrind: 10 minutes at 50% solids in 2 kg Rod Mill for Cu/Ni R.Conc Cu/Ni 1st CI Feed P₈₀ = 24 µm Malvern
 15 minutes at 50% solids in Attrition Mill for Po R.Conc & Cu/Ni Scalp Conc - Ceramic balls Po 1st CI Feed P₈₀ = 13 µm Malvern

Notes: 1. Check Malvern (Rheology Group) on Cycle A, B Cycle B
 2. Assay: Cu, Ni, S, Pt, Pd, Au Cu/Ni 1st CI Feed P₈₀ = 25 µm Malvern
 3. Cu/Ni 1st CI Conc: Weigh filter cake weights, subsample ~5 g (dry) Po 1st CI Feed P₈₀ = 14 µm Malvern

Conditions:

Stage	Reagents added, grams per tonne					Time, minutes			pH	ORP, mV	
	Lime	MaxGold 90	PAX	MIBC*	CMC	CuSO4	Grind	Cond.			Froth
Grind	110	5					42			8.8	148
Cu/Ni Rougher No. 1				0				1	1	9.0	162
Cu/Ni Rougher No. 2	0		5	5				1	2	~9	174
Cu/Ni Rougher No. 3	0		5	5				1	2	~9	175
Po Rougher No. 1	0		10	0				1	3	natural pH	180
Po Rougher No. 2	0		10	5				1	4	natural pH	185
Po Rougher No. 3	0		10	10				1	4	natural pH	185
Po Rougher Scav	0		30			50		1	4	natural pH	228
Regrind Cu/Ni Ro Conc (2kg Rod Mill)	225						10			9.8	183
Cu/Ni 1st Cleaner No.1			0		30			1	2	9.8	146
Cu/Ni 1st Cleaner No.2	0		1	0				1	2	~	159
Cu/Ni 1st Cleaner Scav	40		0	1	0			1	1	9.5	127
Regrind Cu/Ni 1st CI Scav Tails + Po Ro Conc 1-3 (Attrition Mill)	150						15			10.5	124
Po 1st Cleaner	0		2		40			1	2	10.5	129
Po 1st Cleaner Scav	0		0	2				1	2	~	180
Po 2nd Cleaner	5		1					1	2	9.0	191
Po 3rd Cleaner	5		1					1	2	9.0	179
Total	425	0	5	78		50	25	14	33		

May only need 3 minutes

* Add as required.

Stage	Rougher/Scavenger	Po Rougher	Cu/Ni 1st/2nd Cleaner	Po 1st & 2nd CI
Flotation Cell	2 kg float cell	2 kg float cell	500g/250g float cell	250g float cell
Speed: r.p.m.	1800	1800	1500/1200	1200

TARGET WEIGHTS	Target,%	Wt. (Dry g.)	Wt. (Wet w.Paper, g)	A	B	C	D	E	F
Cu/Ni 1st Clnr Conc (exit)	3.0%	60	84	70	64.83	73.28	85.85	103.4	79.4
Po 3rd/2nd Clnr Conc (exit)	0.6%	12	27	17.84	27.67	25.93	29.27	25.02	24.65
Po 1st Cl Scav Tails (exit)	13.0%	260	319	174.97	300.45	364.38	389.91	349.42	
Po Ro Scav Conc (exit)	3.10%	62	86						
Po Ro Scav Tail (exit)	81.0%	1620	1919						
Cu/Ni Ro Conc (intermediate)	10-12%	200-240	248-295						
Po Ro Conc (Intermediate)	9.0%	180	225						

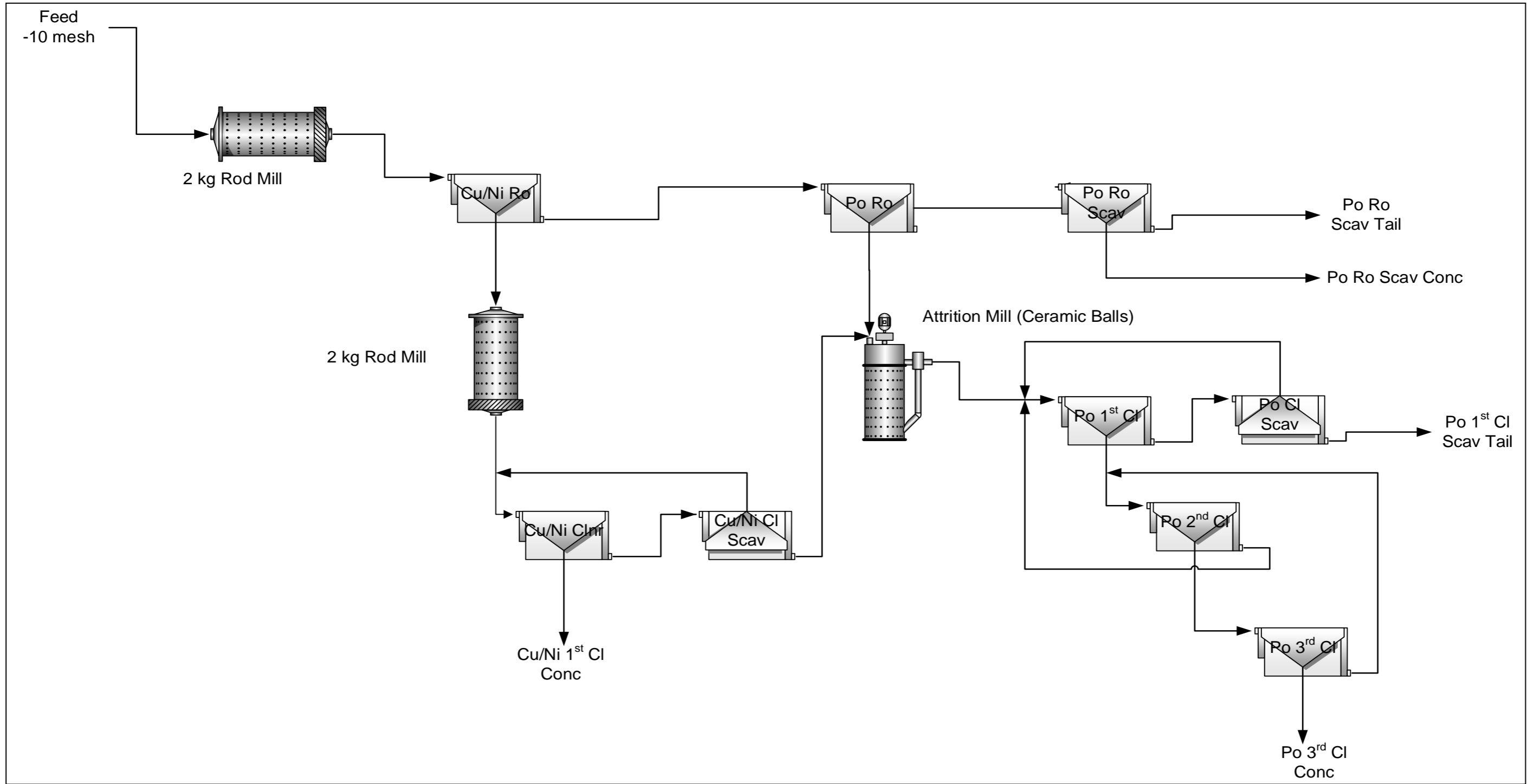

Test: LCT-4 **Project:** 18559-01 **Date:** 09-13-2021 **Operator:** Marteen

Purpose: Based on F-35, F24, no DETA

Feed: 2kg LG Comp -10 mesh Freezer\SEC-36E Box 116686

Grind: 42 minutes at 65% solids in 2 kg Rod Mill # 3 Target P₈₀ =
Regrind: 0 minutes at 50% solids in 2 kg Rod Mill for Cu/Ni R.Conc P₈₀ = Malvern
 0 minutes at 50% solids in Attrition Mill for Po R.Conc & Cu/Ni Scalp Conc - Ceramic balls P₈₀ = Malvern

- Notes**
1. Check Malvern (Rheology Group) on Cycle A, B
 2. Assay: Cu, Ni, S, Pt, Pd, Au
 3. Cu/Ni 1st CI Conc: Weigh filter cake weights, subsample ~5 g (dry)

Conditions:

Cycle A Roughers

Stage	Reagents added, grams per tonne						Time, minutes			pH	ORP, mV
	Lime	MaxGold 900	PAX	MIBC*	CMC	CuSO4	Grind	Cond.	Froth		
Grind	110	5					42			8.8	148
Cu/Ni Rougher No. 1				0				1	1	9.0	162
Cu/Ni Rougher No. 2	0		5	5				1	2	~9	174
Cu/Ni Rougher No. 3	0		5	5				1	2	~9	175
Po Rougher No. 1	0		10	0				1	3	natural pH	180
Po Rougher No. 2	0		10	5				1	5	natural pH	185
Po Rougher No. 3	0		10	10				1	5	natural pH	185
Po Rougher Scav	0		30			50		1	4	natural pH	228
Regrind Cu/Ni Ro Conc (2kg Rod Mill)	225						10			9.2	172
Cu/Ni 1st Cleaner No.1			0		30			1	2	9.5	135
Cu/Ni 1st Cleaner No.2	0		1	7.5				1	2	~	153
Cu/Ni 1st Cleaner Scav	40	0	0	2.5				1	2	9.5	127
Regrind Cu/Ni 1st CI Scav Tails + Po Ro Conc 1-3 (Attrition Mill)	150						15			9.5	154
Po 1st Cleaner	0		2		40			1	2	9.5	154
Po 1st Cleaner Scav	0	0	0					1	2	~	171
Po 2nd Cleaner			*					1	2	9.0	
Po 3rd Cleaner			*					1	2	9.0	
Total	415	0	0	73		50	25	14	36		

* Add as required.

Stage	Rougher/Scavenger	Po Rougher	Cu/Ni 1st/2nd Cleaner	Po 1st & 2nd CI
Flotation Cell	2 kg float cell	2 kg float cell	500g/250g float cell	250g float cell
Speed: r.p.m.	1800	1800	1500/1200	1200

Cycle B

Stage	Reagents added, grams per tonne						Time, minutes			pH	ORP, mV
	Lime	MaxGold 900	PAX	MIBC*	CMC	CuSO4	Grind	Cond.	Froth		
Grind	110	5					42			8.8	148
Cu/Ni Rougher No. 1				0				1	1	9.0	162
Cu/Ni Rougher No. 2	0		5	5				1	2	~9	174
Cu/Ni Rougher No. 3	0		5	5				1	2	~9	175
Po Rougher No. 1	0		10	0				1	3	natural pH	180
Po Rougher No. 2	0		10	5				1	5	natural pH	185
Po Rougher No. 3	0		10	10				1	5	natural pH	185
Po Rougher Scav	0		30			50		1	4	natural pH	228
Regrind Cu/Ni Ro Conc (2kg Rod Mill)	225						10			9.2	172
Regrind Cu/Ni 1st Cl Scav Tails + Po Ro Conc 1-3 (Attrition Mill)	150						15			9.5	154

Cycle C

Stage	Reagents added, grams per tonne						Time, minutes			pH	ORP, mV
	Lime	MaxGold 900	PAX	MIBC*	CMC	CuSO4	Grind	Cond.	Froth		
Grind	110	5					42			8.8	148
Cu/Ni Rougher No. 1				0				1	1	9.0	162
Cu/Ni Rougher No. 2	0		5	5				1	2	~9	174
Cu/Ni Rougher No. 3	0		5	5				1	2	~9	175
Po Rougher No. 1	0		10	0				1	3	natural pH	180
Po Rougher No. 2	0		10	5				1	5	natural pH	185
Po Rougher No. 3	0		10	10				1	5	natural pH	185
Po Rougher Scav	0		30			50		1	4	natural pH	228
Regrind Cu/Ni Ro Conc (2kg Rod Mill)	225						10			9.2	172
Regrind Cu/Ni 1st Cl Scav Tails + Po Ro Conc 1-3 (Attrition Mill)	150						15			9.5	154

Cycle D

Stage	Reagents added, grams per tonne						Time, minutes			pH	ORP, mV
	Lime	MaxGold 900	PAX	MIBC*	CMC	CuSO4	Grind	Cond.	Froth		
Grind	110	5					42			8.8	148
Cu/Ni Rougher No. 1				0				1	1	9.0	162
Cu/Ni Rougher No. 2	0		5+1	5				1	2	~9	174
Cu/Ni Rougher No. 3	0		5+1	5				1	2	~9	175
Po Rougher No. 1	0		10	0				1	3	natural pH	180
Po Rougher No. 2	0		10	5				1	5	natural pH	185
Po Rougher No. 3	0		10	10				1	5	natural pH	185
Po Rougher Scav	0		30			50		1	4	natural pH	228
Regrind Cu/Ni Ro Conc (2kg Rod Mill)	225						10			9.2	172
Regrind Cu/Ni 1st CI Scav Tails + Po Ro Conc 1-3 (Attrition Mill)	150						15			9.5	154

Cycle E

Stage	Reagents added, grams per tonne						Time, minutes			pH	ORP, mV
	Lime	MaxGold 900	PAX	MIBC*	CMC	CuSO4	Grind	Cond.	Froth		
Grind	110	5					42			8.8	148
Cu/Ni Rougher No. 1				0				1	1	9.0	162
Cu/Ni Rougher No. 2	0		5+1	5				1	2	~9	174
Cu/Ni Rougher No. 3	0		5+1	5				1	2	~9	175
Po Rougher No. 1	0		10	0				1	3	natural pH	180
Po Rougher No. 2	0		10	5				1	5	natural pH	185
Po Rougher No. 3	0		10	10				1	5	natural pH	185
Po Rougher Scav	0		30			50		1	4	natural pH	228
Regrind Cu/Ni Ro Conc (2kg Rod Mill)	225						10			9.2	172
Regrind Cu/Ni 1st CI Scav Tails + Po Ro Conc 1-3 (Attrition Mill)	150						15			9.5	154

Cycle F

Stage	Reagents added, grams per tonne						Time, minutes			pH	ORP, mV
	Lime	MaxGold 900	PAX	MIBC*	CMC	CuSO4	Grind	Cond.	Froth		
Grind	110	5					42			8.8	148
Cu/Ni Rougher No. 1				0				1	1	9.0	162
Cu/Ni Rougher No. 2	0		5+1	5				1	2	~9	174
Cu/Ni Rougher No. 3	0		5+1	5				1	2	~9	175
Po Rougher No. 1	0		10	0				1	3	natural pH	180
Po Rougher No. 2	0		10	5				1	5	natural pH	185
Po Rougher No. 3	0		10	10				1	5	natural pH	185
Po Rougher Scav	0		30			50		1	4	natural pH	228
Regrind Cu/Ni Ro Conc (2kg Rod Mill)	225						10			9.2	172
Regrind Cu/Ni 1st Cl Scav Tails + Po Ro Conc 1-3 (Attrition Mill)	150						15			9.5	154

Test: LCT-4 **Project:** 18559-01 **Date:** 09-13-2021 **Operator:** Deepak

Purpose: Based on F-35, F24, no DETA

Feed: 2kg LG Comp -10 mesh Freezer\SEC-36E Box 116686

Grind: 42 minutes at 65% solids in 2 kg Rod Mill # 3 Target P₈₀ =
Regrind: minutes at 50% solids in 2 kg Rod Mill for Cu/Ni R.Conc P₈₀ = Malvern
 minutes at 50% solids in Attrition Mill for Po R.Conc & Cu/Ni Scalp Conc - Ceramic balls P₈₀ = Malvern

Notes:
 1. Check Malvern (Rheology Group) on Cycle A, B Cycle B
 2. Assay: Cu, Ni, S, Pt, Pd, Au Cu/Ni 1st CI Feed P₈₀ = 24 µm Malvern
 3. Cu/Ni 1st CI Conc: Weigh filter cake weights, subsample ~5 g (dry) Po 1st CI Feed P₈₀ = 13 µm Malvern

Conditions:

Cycle A Cleaners

Stage	Reagents added, grams per tonne						Time, minutes			pH	ORP, mV
	Lime	MaxGold 900	PAX	MIBC*	CMC	CuSO4	Grind	Cond.	Froth		
Grind	110	5					42			8.8	148
Cu/Ni Rougher No. 1				0				1	1	9.0	162
Cu/Ni Rougher No. 2	0		5	5				1	2	~9	174
Cu/Ni Rougher No. 3	0		5	5				1	2	~9	175
Po Rougher No. 1	0		10	0				1	3	natural pH	180
Po Rougher No. 2	0		10	5				1	5	natural pH	185
Po Rougher No. 3	0		10	10				1	5	natural pH	185
Po Rougher Scav	0		30			50		1	4	natural pH	228
Regrind Cu/Ni Ro Conc (2kg Rod Mill)	225						10			9.8	183
Cu/Ni 1st Cleaner No.1			0		30			1	2	9.8	146
Cu/Ni 1st Cleaner No.2	0		1	0				1	2	~	159
Cu/Ni 1st Cleaner Scav	40		0	1				1	1	9.5	127
Regrind Cu/Ni 1st CI Scav Tails + Po Ro Conc 1-3 (Attrition Mill)	150						15			10.5	124
Po 1st Cleaner	0		2		40			1	2	10.5	129
Po 1st Cleaner Scav	0		0	2				1	2	~	180
Po 2nd Cleaner	5		1					1	2	9.0	191
Po 3rd Cleaner	5		1					1	2	9.0	179
Total	425	0	0	78		50	25	14	35		

* Add as required.

Stage	Rougher/Scavenger	Po Rougher	Cu/Ni 1st/2nd Cleaner	Po 1st & 2nd CI
Flotation Cell	2 kg float cell	2 kg float cell	500g/250g float cell	500 g??/250g float cell
Speed: r.p.m.	1800	1800	1500/1200	1200

Cycle B

Stage	Reagents added, grams per tonne					Time, minutes			pH	ORP, mV
	Lime	MaxGold 900	PAX	MIBC*	CMC	Grind	Cond.	Froth		
Regrind Cu/Ni Ro Conc (2kg Rod Mill)	200					10			9.5	168
Feed: Cu/Ni Ro Conc (regrind)+1st CI Scav Conc										
Cu/Ni 1st Cleaner No.1		0	0		30		1	2	9.5	168
Cu/Ni 1st Cleaner No.2	0		1	0			1	2	~	176
Cu/Ni 1st Cleaner Scav	25	0	1	0			1	2	9.5	139
Regrind Cu/Ni 1st CI Scav Tails + Po Ro Conc 1-3 (Attrition Mill)	150					15			8.7	220
Feed: Po Ro Conc&Cu/Ni CI Scav Tails (regrind)+ Po 1st CI Scav Conc + Po 2nd CI Tails										
Po 1st Cleaner	30	0	2		40		1	2	9.5	210
Po 1st Cleaner Scav	0	0	1				1	2	~	203
Feed: Po 1st CI Conc+ Po 2nd CI Tails										
Po 2nd Cleaner	5		0				1	2	9.0	195
Feed: Po 2nd CI Conc+ Po 3rd CI Tails										
Po 3rd Cleaner	5		0				1	2	9.0	182

Cycle C

Stage	Reagents added, grams per tonne					Time, minutes			pH	ORP, mV
	Lime	MaxGold 900	PAX	MIBC*	CMC	Grind	Cond.	Froth		
Regrind Cu/Ni Ro Conc (2kg Rod Mill)	225					10			9.6	158
Feed: Cu/Ni Ro Conc (regrind)+1st CI Scav Conc										
Cu/Ni 1st Cleaner No.1		0	0		30		1	2	9.6	158
Cu/Ni 1st Cleaner No.2	0		2	0			1	2	~	171
Cu/Ni 1st Cleaner Scav	25	0	2	0			1	2	9.5	158
Regrind Cu/Ni 1st CI Scav Tails + Po Ro Conc 1-3 (Attrition Mill)	150					15			9.5	161
Feed: Po Ro Conc&Cu/Ni CI Scav Tails (regrind)+ Po 1st CI Scav Conc + Po 2nd CI Tails										
Po 1st Cleaner	0	0	2		40		1	2	9.5	150
Po 1st Cleaner Scav	0	0	1				1	2	~	175
Feed: Po 1st CI Conc+ Po 2nd CI Tails										
Po 2nd Cleaner	5		0				1	2	9.0	171
Feed: Po 2nd CI Conc+ Po 3rd CI Tails										
Po 3rd Cleaner	5		0				1	2	9.0	179

Cycle D

Stage	Reagents added, grams per tonne					Time, minutes			pH	ORP, mV
	Lime	MaxGold 900	PAX	MIBC*	CMC	Grind	Cond.	Froth		
Regrind Cu/Ni Ro Conc (2kg Rod Mill)	200					10			9.5	147
Feed: Cu/Ni Ro Conc (regrind)+1st CI Scav Conc										
Cu/Ni 1st Cleaner No.1		0	0		30		1	2	9.5	147
Cu/Ni 1st Cleaner No.2	0		2	0			1	2	~	162
Cu/Ni 1st Cleaner Scav	10	0	2	0			1	2	9.5	149
Regrind Cu/Ni 1st CI Scav Tails + Po Ro Conc 1-3 (Attrition Mill)	150					15			9.6	148
Feed: Po Ro Conc&Cu/Ni CI Scav Tails (regrind)+ Po 1st CI Scav Conc + Po 2nd CI Tails										
Po 1st Cleaner	0	0	2		40		1	2	9.6	148
Po 1st Cleaner Scav	0	0	1				1	2	~	161
Feed: Po 1st CI Conc+ Po 2nd CI Tails										
Po 2nd Cleaner	5		0				1	2	9.0	184
Feed: Po 2nd CI Conc+ Po 3rd CI Tails										
Po 3rd Cleaner	5		0				1	2	9.0	161

Cycle E

Stage	Reagents added, grams per tonne					Time, minutes			pH	ORP, mV
	Lime	MaxGold 900	PAX	MIBC*	CMC	Grind	Cond.	Froth		
Regrind Cu/Ni Ro Conc (2kg Rod Mill)	200					10			9.6	144
Feed: Cu/Ni Ro Conc (regrind)+1st CI Scav Conc										
Cu/Ni 1st Cleaner No.1		0	0		30		1	2	9.6	144
Cu/Ni 1st Cleaner No.2	0		2	0			1	2	~	165
Cu/Ni 1st Cleaner Scav	10	0	2	0			1	2	9.5	148
Regrind Cu/Ni 1st CI Scav Tails + Po Ro Conc 1-3 (Attrition Mill)	150					15			9.5	171
Feed: Po Ro Conc&Cu/Ni CI Scav Tails (regrind)+ Po 1st CI Scav Conc + Po 2nd CI Tails										
Po 1st Cleaner	0	0	2		40		1	2	9.5	171
Po 1st Cleaner Scav	0	0	1				1	2	~	158
Feed: Po 1st CI Conc+ Po 2nd CI Tails										
Po 2nd Cleaner	5		0				1	2	9.0	181
Feed: Po 2nd CI Conc+ Po 3rd CI Tails										
Po 3rd Cleaner	5		0				1	2	9.0	168

Cycle F

Stage	Reagents added, grams per tonne					Time, minutes			pH	ORP, mV
	Lime	MaxGold 900	PAX	MIBC*	CMC	Grind	Cond.	Froth		
Regrind Cu/Ni Ro Conc (2kg Rod Mill)	200					10			9.5	137
Feed: Cu/Ni Ro Conc (regrind)+1st CI Scav Conc										
Cu/Ni 1st Cleaner No.1		0	0		30		1	2	9.5	137
Cu/Ni 1st Cleaner No.2	0		1	0			1	2	~	153
Cu/Ni 1st Cleaner Scav	20	0	2	0			1	2	9.5	146
Regrind Cu/Ni 1st CI Scav Tails + Po Ro Conc 1-3 (Attrition Mill)	150					15			9.6	164
Feed: Po Ro Conc&Cu/Ni CI Scav Tails (regrind)+ Po 1st CI Scav Conc + Po 2nd CI Tails										
Po 1st Cleaner	0	0	2		40		1	2	9.6	164
Po 1st Cleaner Scav	0	0	1				1	2	~	168
Feed: Po 1st CI Conc+ Po 2nd CI Tails										
Po 2nd Cleaner	5		0				1	2	9.0	173
Feed: Po 2nd CI Conc+ Po 3rd CI Tails										
Po 3rd Cleaner	5		0				1	2	9.0	173

Metallurgical Projection (C-F)

Product	Weight		Assays, %, g/t											% Distribution									
	g	%	Cu	Ni	S	Other	Pt, g/t	Pd, g/t	Au, g/t	Cp	Pn	Po	Gn	Cu	Ni	S	Pt	Pd	Au	Cp	Pn	Po	Gn
Cu/Ni 1st CI Conc	384	3.2	12.5	7.39	33.7		3.10	16.0	2.58	36.8	19.7	45.3	3.5	81.7	52.9	18.8	43.4	61.7	68.9	81.7	64.8	9.7	0.1
Po 3rd CI Conc	53	0.4	5.01	10.4	36.3		5.89	14.4	1.50	14.7	27.8	57.9	-3.1	4.5	10.4	2.8	11.4	7.7	5.5	4.5	12.7	2.0	0.0
Combined Cu/Ni Conc	438	3.6	11.7	7.79	34.1		3.45	15.9	2.46	34.2	20.8	43.0	2.4	86.2	63.2	21.6	54.8	69.4	74.4	86.2	77.4	11.7	0.1
Po 1st CI Tails	1610	13.3	0.20	0.74	22.5		0.23	0.57	0.06	0.58	1.20	58.9	39.8	5.4	22.3	52.5	13.7	9.1	7.0	5.4	16.5	59.4	6.2
Po Ro Scav Conc	490	4.0	0.12	0.52	25.0		0.25	0.54	0.06	0.34	0.50	69.0	33.8	1.0	4.8	17.8	4.5	2.6	2.1	1.0	2.1	20.4	1.6
Po Rougher Tail	9583	79.1	0.05	0.05	0.59		0.08	0.20	0.02	0.13	0.05	1.4	98.4	7.4	9.7	8.2	27.0	18.9	16.6	7.4	4.0	8.5	92.2
Head (Calc.)	12120	100	0.49	0.44	5.72		0.23	0.83	0.12	1.43	0.97	13.2	84.7	100	100	100	100	100	100	100	100	100	100
Head (Dir.)			0.55	0.44	5.76	93.3	0.18	0.82	0.07	1.61	0.96	13.2	84.2										

Metallurgical Balance

Product	Weight		Assays, %, g/t											% Distribution									
	g	%	Cu	Ni	S	Other	Pt, g/t	Pd, g/t	Au, g/t	Cp	Pn	Po	Gn	Cu	Ni	S	Pt	Pd	Au	Cp	Pn	Po	Gn
LCT-4 Cu/Ni 1st CI Conc-A	50.4	0.4	14.2	7.80	33.5	44.5	3.86	19.5	1.88	41.6	21.0	34.4	3.0	12.3	7.4	2.5	7.2	9.9	7.1	12.3	9.1	1.1	0.0
LCT-4 Cu/Ni 1st CI Conc-B	45.8	0.4	16.6	7.88	33.4	42.1	3.90	20.7	2.47	48.7	21.3	27.4	2.6	13.1	6.8	2.3	6.6	9.6	8.5	13.1	8.4	0.8	0.0
LCT-4 Cu/Ni 1st CI Conc-C	53.3	0.4	15.7	7.66	33.5	43.1	3.26	19.2	2.50*	46.0	20.6	30.6	2.7	14.4	7.7	2.7	6.4	10.3	10.0	14.4	9.5	1.1	0.0
LCT-4 Cu/Ni 1st CI Conc-D	64.4	0.5	11.5	7.51	33.9	47.1	3.26	15.4	3.39	33.7	20.0	43.4	2.8	12.8	9.1	3.2	7.7	10.0	16.4	12.8	11.2	1.8	0.0
LCT-4 Cu/Ni 1st CI Conc-E	79.9	0.7	10.1	6.79	33.6	49.5	2.72	13.1	1.42	29.6	18.0	48.1	4.3	13.9	10.3	4.0	8.0	10.6	8.5	13.9	12.4	2.5	0.0
LCT-4 Cu/Ni 1st CI Conc-F	58.7	0.5	14.1	7.82	33.7	44.4	3.30	17.9	3.36	41.3	21.0	35.1	2.5	14.3	8.7	2.9	7.1	10.6	14.8	14.3	10.7	1.3	0.0
LCT-4 Cu/Ni 1st CI Scav Conc-F	15.8	0.1	3.08	5.47	33.5	58.0	1.61	5.94	0.45	9.03	14.1	69.9	7.0	0.8	1.6	0.8	0.9	0.9	0.5	0.8	1.9	0.7	0.0
LCT-4 Cu/Ni 1st CI Scav Tails-F	134.7	1.1	0.45	1.33	22.4	75.8	0.46	1.08	0.11	1.32	2.84	56.6	39.2	1.0	3.4	4.5	2.3	1.5	1.1	1.0	3.3	4.9	0.5
LCT-4 Po 3rd CI Conc-A	2.8	0.0	5.39	8.32	34.5	51.8	8.27	22.8	3.99	15.8	22.0	59.7	2.5	0.3	0.4	0.1	0.9	0.6	0.8	0.3	0.5	0.1	0.0
LCT-4 Po 3rd CI Conc-B	9.9	0.1	3.10	7.38	36.8	52.7	3.57	7.51	0.87	9.09	19.3	74.3	-2.7	0.5	1.4	0.5	1.3	0.8	0.6	0.5	1.6	0.5	0.0
LCT-4 Po 3rd CI Conc-C	9.4	0.1	4.83	8.95	36.6	49.6	5.46	13.0	1.65	14.2	23.7	65.4	-3.3	0.8	1.6	0.5	1.9	1.2	1.2	0.8	1.9	0.4	0.0
LCT-4 Po 3rd CI Conc-D	8.6	0.1	5.47	11.1	37.0	46.4	6.19	14.6	1.46	16.0	29.7	59.7	-5.4	0.8	1.8	0.5	2.0	1.3	0.9	0.8	2.2	0.3	0.0
LCT-4 Po 3rd CI Conc-E	8.9	0.1	5.17	11.4	35.9	47.5	6.31	15.7	1.48	15.2	30.5	56.8	-2.5	0.8	1.9	0.5	2.1	1.4	1.0	0.8	2.4	0.3	0.0
LCT-4 Po 3rd CI Conc-F	8.7	0.1	4.59	10.4	35.8	49.2	5.64	14.3	1.38	13.5	27.7	60.5	-1.7	0.7	1.7	0.5	1.8	1.3	0.9	0.7	2.1	0.3	0.0
LCT-4 Po 3rd CI Tails-F	9.8	0.1	1.14	4.74	33.2	60.9	1.32	3.22	0.28	3.34	12.0	76.1	8.6	0.2	0.9	0.5	0.5	0.3	0.2	0.2	1.0	0.5	0.0
LCT-4 Po 2nd CI Tails-F	40.5	0.3	0.46	2.02	27.4	70.1	0.48	1.25	0.12	1.35	4.59	68.5	25.5	0.3	1.5	1.7	0.7	0.5	0.4	0.3	1.6	1.8	0.1
LCT-4 Po 1st CI Scav Conc-F	17.8	0.1	0.92	2.70	31.1	65.3	0.86	2.52	0.21	2.70	6.36	75.8	15.2	0.3	0.9	0.8	0.6	0.5	0.3	0.3	1.0	0.9	0.0
LCT-4 Po 1st CI Scav Tails-A	118.8	1.0	0.07	0.47	23.7	75.8	0.14	0.26	0.05	0.21	0.39	63.2	36.2	0.1	1.1	4.2	0.6	0.3	0.4	0.1	0.4	4.8	0.4
LCT-4 Po 1st CI Scav Tails-B	211.7	1.8	0.13	0.58	21.7	77.6	0.18	0.45	0.06	0.38	0.77	57.3	41.5	0.5	2.3	6.8	1.4	1.0	1.0	0.5	1.4	7.8	0.9
LCT-4 Po 1st CI Scav Tails-C	262.7	2.2	0.15	0.65	22.9	76.3	0.21	0.48	0.06	0.44	0.92	60.4	38.3	0.7	3.2	9.0	2.0	1.3	1.2	0.7	2.1	10.2	1.0
LCT-4 Po 1st CI Scav Tails-D	282.3	2.3	0.19	0.81	23.5	75.5	0.24	0.57	0.06	0.56	1.35	61.5	36.6	0.9	4.3	9.9	2.5	1.6	1.3	0.9	3.3	11.2	1.0
LCT-4 Po 1st CI Scav Tails-E	248.3	2.1	0.28	0.88	22.6	76.2	0.28	0.70	0.07	0.82	1.58	58.7	38.9	1.2	4.1	8.4	2.6	1.8	1.3	1.2	3.4	9.4	0.9
LCT-4 Po 1st CI Scav Tails-F	279.7	2.3	0.18	0.64	21.1	78.1	0.21	0.52	0.06	0.53	0.96	55.4	43.1	0.9	3.4	8.8	2.2	1.5	1.3	0.9	2.3	10.0	1.2
LCT-4 Po Ro Scav Conc-A	57.6	0.5	0.13	0.48	17.0	82.4	0.27	0.62	0.06	0.38	0.66	44.8	54.2	0.1	0.5	1.5	0.6	0.4	0.3	0.1	0.3	1.7	0.3
LCT-4 Po Ro Scav Conc-B	89.7	0.7	0.12	0.56	23.0	76.3	0.24	0.54	0.06	0.35	0.67	60.9	38.0	0.2	0.9	3.1	0.8	0.5	0.4	0.2	0.5	3.5	0.3
LCT-4 Po Ro Scav Conc-C	72.8	0.6	0.11	0.59	25.1	74.2	0.27	0.52	0.05	0.32	0.68	66.6	32.4	0.1	0.8	2.7	0.7	0.4	0.3	0.1	0.4	3.1	0.2
LCT-4 Po Ro Scav Conc-D	91.1	0.8	0.13	0.48	24.4	75.0	0.24	0.57	0.06	0.38	0.40	64.9	34.3	0.2	0.8	3.3	0.8	0.5	0.4	0.2	0.3	3.8	0.3
LCT-4 Po Ro Scav Conc-E	90.7	0.8	0.11	0.48	26.3	73.1	0.26	0.51	0.07	0.32	0.33	70.1	29.2	0.2	0.8	3.6	0.9	0.5	0.5	0.2	0.3	4.1	0.3
LCT-4 Po Ro Scav Conc-F	72.3	0.6	0.11	0.57	24.2	75.1	0.23	0.54	0.06	0.32	0.66	64.2	34.8	0.1	0.8	2.6	0.6	0.4	0.3	0.1	0.4	3.0	0.2
LCT-4 Po Ro Scav Tails-A	1590	13.2	0.04	0.05	0.45	99.5	0.07	0.18	0.02	0.13	0.04	1.05	98.8	1.2	1.5	1.1	4.1	2.9	2.4	1.2	0.6	1.1	15.3
LCT-4 Po Ro Scav Tails-B	1601	13.3	0.04	0.05	0.48	99.4	0.07	0.18	0.03	0.13	0.04	1.14	98.7	1.2	1.5	1.1	4.1	2.9	3.6	1.2	0.6	1.2	15.4
LCT-4 Po Ro Scav Tails-C	1597	13.2	0.04	0.06	0.55	99.4	0.08	0.19	0.03	0.12	0.06	1.32	98.5	1.1	1.8	1.3	4.7	3.1	3.6	1.1	0.8	1.4	15.4
LCT-4 Po Ro Scav Tails-D	1604	13.3	0.05	0.05	0.62	99.3	0.07	0.19	0.02	0.14	0.04	1.51	98.3	1.3	1.5	1.5	4.1	3.1	2.4	1.3	0.5	1.6	15.4
LCT-4 Po Ro Scav Tails-E	1594	13.2	0.04	0.05	0.64	99.3	0.08	0.20	0.02	0.12	0.05	1.6	98.3	1.2	1.6	1.5	4.7	3.2	2.4	1.2	0.6	1.6	15.3
LCT-4 Po Ro Scav Tails-F	1593	13.2	0.05	0.06	0.54	99.4	0.08	0.21	0.03	0.15	0.06	1.27	98.5	1.4	1.7	1.3	4.7	3.4	3.6	1.4	0.8	1.3	15.3
Head (Calc.)	12077	100	0.48	0.44	5.6	93.5	0.22	0.82	0.11	1.41	0.96	12.9	84.8	100	100	100	100	100	100	100	100	100	100
Head (Dir.)			0.55	0.44	5.8	93.3	0.18	0.82	0.07	1.61	0.96	13.2	84.2										

Combined Products

Product	Weight		Assays, %, g/t											% Distribution									
	g	%	Cu	Ni	S	Other	Pt, g/t	Pd, g/t	Au, g/t	Cp	Pn	Po	Gn	Cu	Ni	S	Pt	Pd	Au	Cp	Pn	Po	Gn
Cu/Ni 1st CI Conc A-F	2.9	13.3	7.51	33.6	45.6	3.31	17.1	2.47	39.0	20.1	37.8	3.1	80.8	50.0	17.6	43.0	61.1	65.4	80.8	61.3	8.6	0.1	
Cu/Ni CI Scav Conc F	0.1	3.08	5.47	33.5	58.0	1.61	5.94	0.45															

Stability

	Weight		Assays,%		
	g	%	Cu	Ni	S
Total In All Cycles	12077	100	0.48	0.44	5.56
Average In Per Cycle	2013	16.7			

Total Products Out Per Cycle	Weight		Units out as a % of Units in/Cycle		
	g	Wt %	Cu	Ni	S
Cycle A	1819	90.4	84.4	65.8	56.2
Cycle B	1958	97.3	92.9	78.1	83.2
Cycle C	1995	99.1	102.9	90.5	96.9
Cycle D	2050	101.9	96.2	105.6	110.3
Cycle E	2022	100.5	103.4	112.5	107.4
Cycle F	2013	100.0	104.2	97.4	96.5

Average of B-F	99.8	99.9	96.8	98.9
Average of C-F	100.4	101.6	101.5	102.8
Average of D-F	100.8	101.2	105.2	104.7

Cycle Statistics (Least Squares)

335	36	371
58	19	77
9	14	23
18	32	50
12	8	20
17	17	34

Cycle Statistics (Least Squares)

0.1	0.02	0.1
2.9	1.65	4.5
2.1	0.21	2.3

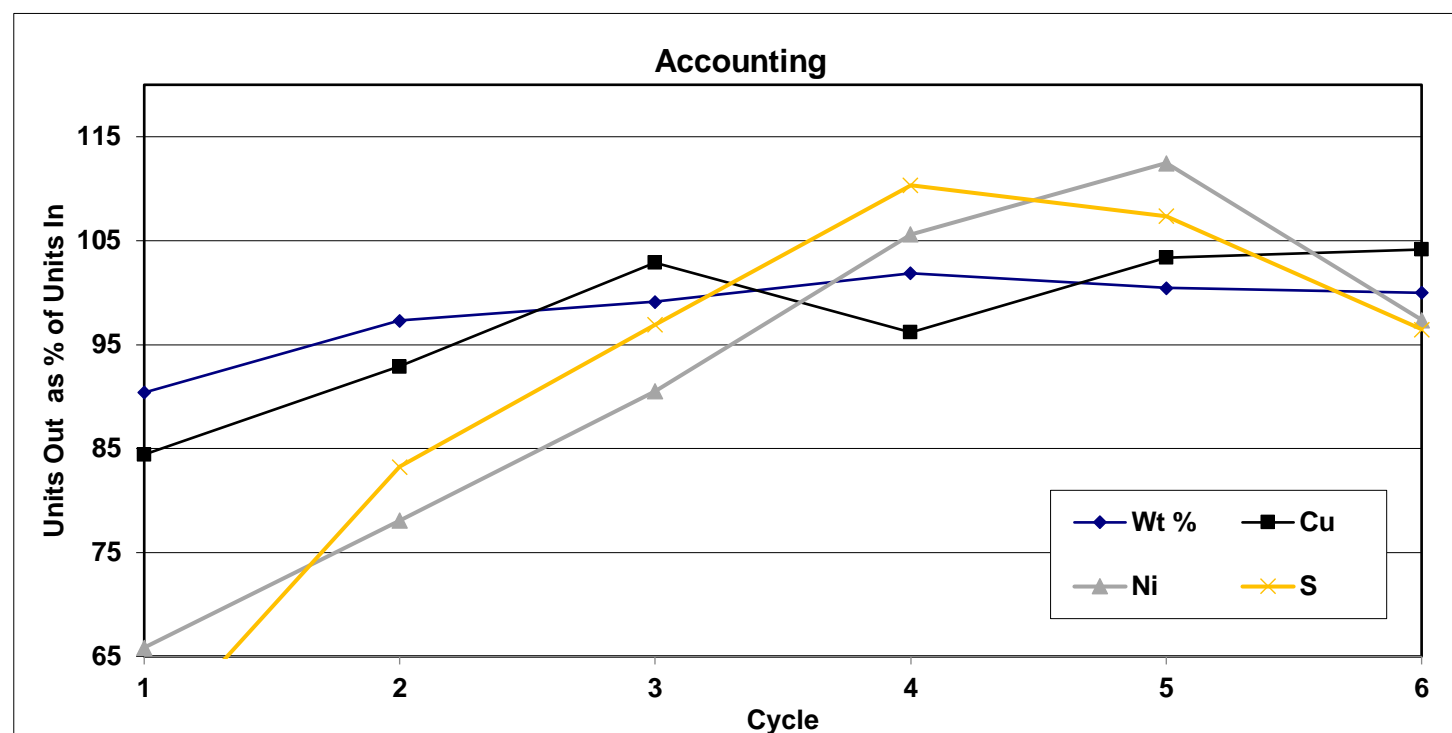

Test: LCT-5

Project: 18559-01

Date: September 14, 2021

Operator: Deepak

Purpose:

Cu Sep LCT, Based on F-36

Procedure:

As outlined below.

Feed:

5*~65 g dry (78 g wet) LCT-4 Cu/Ni 1st CI Conc

Grind:

2.5 minutes at 50% solids in Pebble Mill

* adjust dosage based on visual

Cycle A:

Stage	Reagents added, grams per tonne			Time, minutes			pH	ORP, mV
	Lime	PAX*	MIBC*	Grind	Cond.	Froth		
Polish Grind (Pebble mill)	250			2.5			11.5	50
Cu Ro 1	0	0	*			2	11.5	50
Cu Ro 2		0.5	*			2	11.0	50
Cu Ro Scav		0.5	*		1	1	11.0	101
Cu 1st CI		0			1	3	11.5	23
Cu 2nd CI		0			1	3	11.5	24
Cu 3rd CI		0			1	2.5	11.5	27

Cycle B:

Stage	Reagents added, grams per tonne			Time, minutes			pH	ORP, mV
	Lime	PAX	MIBC*	Grind	Cond.	Froth		
Polish Grind (Pebble mill)	250			2.5			11.5	31
<i>Grind Discharge+Ro Scav Conc+1st CI Tails</i>								
Cu Ro 1	0	0.5				2	11.5	30
Cu Ro 2		0				2	11.0	56
Cu Ro Scav		0.5			1	1	11.0	84
<i>Ro Conc+2nd CI Tails</i>								
Cu 1st CI		0			1	3	11.5	26
<i>1st CI Conc +3rd CI Tails</i>								
Cu 2nd CI		0			1	3	11.5	25
Cu 3rd CI		0			1	2.5	11.5	25

Cycle C:

Stage	Reagents added, grams per tonne			Time, minutes			pH	ORP, mV
	Lime	PAX	MIBC*	Grind	Cond.	Froth		
Polish Grind (Pebble mill)	250			2.5			11.3	37
<i>Grind Discharge+Ro Scav Conc+1st CI Tails</i>								
Cu Ro 1		0.5				2	11.5	30
Cu Ro 2		0				2	11.0	70
Cu Ro Scav		0.5			1	1	9.9	114
<i>Ro Conc+2nd CI Tails</i>								
Cu 1st CI		0			1	3	11.5	23
<i>1st CI Conc +3rd CI Tails</i>								
Cu 2nd CI		0			1	3	11.5	27
Cu 3rd CI		0			1	2.5	11.5	18

Cycle D:

Stage	Reagents added, grams per tonne			Time, minutes			pH	ORP, mV
	Lime	PAX	MIBC*	Grind	Cond.	Froth		
Polish Grind (Pebble mill)	250			2.5			11.6	29
Grind Discharge+Ro Scav Conc+1st CI Tails								
Cu Ro 1		0.5				2	11.5	29
Cu Ro 2		0				2	11.1	46
Cu Ro Scav		0.5			1	1	11.0	66
Ro Conc+2nd CI Tails								
Cu 1st CI		0			1	3	11.5	23
1st CI Conc +3rd CI Tails								
Cu 2nd CI		0			1	3	11.5	21
Cu 3rd CI		0			1	2.5	11.5	20

Cycle E:

Stage	Reagents added, grams per tonne			Time, minutes			pH	ORP, mV
	Lime	PAX	MIBC*	Grind	Cond.	Froth		
Polish Grind (Pebble mill)	250			2.5			11.3	42
Grind Discharge+Ro Scav Conc+1st CI Tails								
Cu Ro 1		0.5				2	11.5	17
Cu Ro 2		0				2	11.5	40
Cu Ro Scav		0.5			1	1	11.5	61
Ro Conc+2nd CI Tails								
Cu 1st CI		0			1	3	11.5	18
1st CI Conc +3rd CI Tails								
Cu 2nd CI		0			1	3	11.5	24
Cu 3rd CI		0			1	2.5	11.5	16

TARGET WEIGHTS	Wt. (Dry g.)	Wt. (Wet w.Paper, g)	A	B	C	D	E		
Cu 3rd CI Conc (exit)	23	40	30.76	37.75	35.96	38.53	32.62		
Cu Ro Scav Tail (exit)	42	62	60.15	73.24	69.04	74.52	73.22		
Cu 3rd CI Tails -F (exit)									
Cu 2nd CI Tails -F (exit)									
Cu 1st CI Tails -F (exit)									
Cu Ro Scav Conc -F (exit)									
Cu Ro Conc (intermediate)									

Stage	Rougher/Scavenger	Cu 1st/2nd/3rd Cleaner		
Flotation Cell	1 kg float cell	500g/250g float cell		
Speed: r.p.m.		1500/1200		

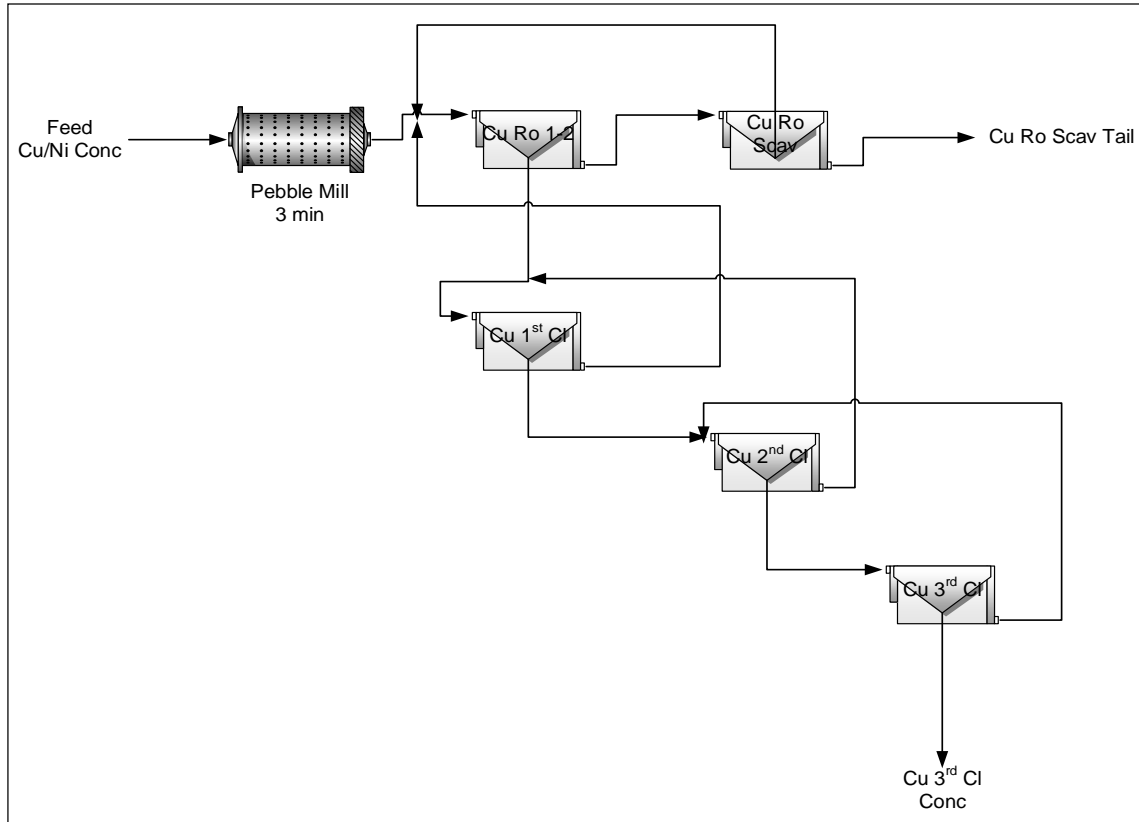

Metallurgical Projection (B-E)

Product	Weight		Assays, %											% Distribution									
	g	%	Cu	Ni	S	Other	Pt, g/t	Pd, g/t	Au, g/t	Cp	Pn	Po	Gn	Cu	Ni	S	Pt	Pd	Au	Cp	Pn	Po	Gn
Cu 3rd Cl Conc	96	29.6	33.2	0.33	34.5		1.72	39.7	3.22	97.4	0.9	3.1	-1.4	68.3	1.4	31.1	17.7	66.3	58.3	68.3	1.3	2.8	-8.1
Cu Ro Scav Tail	228	70.4	6.50	9.91	32.1		3.35	8.50	0.97	19.1	26.6	46.5	7.8	31.7	98.6	68.9	82.3	33.7	41.7	31.7	98.7	97.2	108.1
Head (Calc.)	325	100	14.4	7.07	32.8		2.87	17.7	1.64	42.3	19.0	33.7	5.1	100	100	100	100	100	100	100	100	100	100
Head (Dir.)																							

Metallurgical Balance

Product	Weight		Assays, %											% Distribution									
	g	%	Cu	Ni	S	Other	Pt, g/t	Pd, g/t	Au, g/t	Cp	Pn	Po	Gn	Cu	Ni	S	Pt	Pd	Au	Cp	Pn	Po	Gn
LCT-5 Cu 3rd Cl Conc-A	10.3	3.1	32.9	0.42	34.6	32.1	1.7*	39.8*	3.2*	96.5	1.1	4.2	-1.7	6.8	0.2	3.3	1.8	6.8	4.0	6.8	0.2	0.4	-1.0
LCT-5 Cu 3rd Cl Conc-B	20.5	6.2	33.3	0.35	34.6	31.8	1.8	39.1	2.9	97.7	0.9	3.2	-1.8	13.8	0.3	6.5	3.8	13.3	7.2	13.8	0.3	0.6	-2.1
LCT-5 Cu 3rd Cl Conc-C	19.3	5.8	33.0	0.33	34.7	32.0	1.7	40.4	3.7	96.8	0.8	4.4	-2.0	12.9	0.3	6.2	3.4	13.0	8.7	12.9	0.3	0.8	-2.1
LCT-5 Cu 3rd Cl Conc-D	21.3	6.4	33.1	0.33	34.2	32.4	1.7	39.1	3.3	97.1	0.9	2.7	-0.7	14.2	0.3	6.7	3.7	13.9	8.6	14.2	0.3	0.5	-0.8
LCT-5 Cu 3rd Cl Conc-E	15.8	4.7	33.5	0.29	34.3	31.9	1.6	40.4	2.9	98.2	0.8	2.0	-1.0	10.7	0.2	5.0	2.6	10.6	5.5	10.7	0.2	0.3	-0.9
LCT-5 Cu 3rd Cl Tails-E	5.3	1.6	30.7	1.03	32.9	35.4	3.3	34.8	8.3	90.0	2.8	4.1	3.1	3.3	0.2	1.6	1.8	3.1	5.3	3.3	0.2	0.2	0.9
LCT-5 Cu 2nd Cl Tails-E	8.1	2.4	28.7	2.31	32.3	36.7	3.6	30.8	9.2	84.2	6.3	4.8	4.7	4.7	0.8	2.4	3.0	4.1	9.0	4.7	0.8	0.4	2.1
LCT-5 Cu 1st Cl Tails-E	11.5	3.5	20.5	6.39	31.3	41.8	4.3	22.3	11.0	60.1	17.3	14.7	7.9	4.8	3.2	3.3	5.0	4.3	15.3	4.8	3.2	1.6	5.0
LCT-5 Cu Ro Scav Conc-E	4.0	1.2	23.7	5.00	32.7	38.6	4.3	25.8	24.5	69.5	13.6	13.1	3.9	1.9	0.9	1.2	1.8	1.7	11.9	1.9	0.9	0.5	0.9
LCT-5 Cu Ro Scav Tails-A	34.0	10.2	4.19	10.3	31.6	53.9	3.0	6.0	0.8	12.3	27.6	50.4	9.7	2.9	15.2	9.9	10.3	3.4	3.1	2.9	15.2	15.9	18.4
LCT-5 Cu Ro Scav Tails-B	45.0	13.5	5.73	10.3	32.3	51.7	3.1	7.5	0.7	16.8	27.6	48.1	7.4	5.2	20.1	13.4	14.4	5.6	3.8	5.2	20.1	20.1	18.7
LCT-5 Cu Ro Scav Tails-C	42.0	12.6	5.49	10.1	32.1	52.3	3.4	7.6	1.0	16.1	27.1	48.7	8.1	4.7	18.4	12.4	14.5	5.3	5.2	4.7	18.4	19.0	19.0
LCT-5 Cu Ro Scav Tails-D	48.2	14.5	7.37	9.63	32.0	51.0	3.5	9.6	0.8	21.6	25.8	44.4	8.1	7.2	20.1	14.2	17.2	7.7	4.8	7.2	20.1	19.9	21.8
LCT-5 Cu Ro Scav Tails-E	47.5	14.3	7.23	9.66	32.2	50.9	3.4	9.1	1.3	21.2	25.9	45.3	7.6	6.9	19.9	14.1	16.6	7.2	7.5	6.9	19.9	20.0	20.1
Head (Calc.) A-E	333	100	14.9	6.94	32.7	45.5	2.9	18.1	2.5	43.6	18.6	32.4	5.4	100	100	100	100	100	100	100	100	100	100
Head - LCT-4 Cu/Ni 1st Cl Conc A-F			13.3	7.51	33.6		3.3	17.1	2.5														

* No PGE on Cu 3rd Cl Conc - A, use Average of B-E

Combined Products (A-E)

Product	Weight		Assays, %											% Distribution									
	g	%	Cu	Ni	S	Other	Pt, g/t	Pd, g/t	Au, g/t	Cp	Pn	Po	Gn	Cu	Ni	S	Pt	Pd	Au	Cp	Pn	Po	Gn
Cu 3rd Cl Conc A-E	87.2	26.2	33.2	0.34	34.5		1.7	39.7	3.2	97.3	0.9	3.3	-1.4	58.5	1.3	27.6	15.3	57.6	34.0	58.5	1.2	2.6	-6.9
Cu 3rd Cl Tails -E	5.3	1.6	30.7	1.03	32.9		3.3	34.8	8.3	90.0	2.8	4.1	3.1	3.3	0.2	1.6	1.8	3.1	5.3	3.3	0.2	0.2	0.9
Cu 2nd Cl Tails -E	8.1	2.4	28.7	2.31	32.3		3.6	30.8	9.2	84.2	6.3	4.8	4.7	4.7	0.8	2.4	3.0	4.1	9.0	4.7	0.8	0.4	2.1
Cu 1st Cl Tails -E	11.5	3.5	20.5	6.39	31.3		4.3	22.3	11.0	60.1	17.3	14.7	7.9	4.8	3.2	3.3	5.0	4.3	15.3	4.8	3.2	1.6	5.0
Cu Ro Scav Conc -E	4.0	1.2	23.7	5.00	32.7		4.3	25.8	24.5	69.5	13.6	13.1	3.9	1.9	0.9	1.2	1.8	1.7	11.9	1.9	0.9	0.5	0.9
Cu Ro Scav Tails A-E	216.7	65.1	6.14	10.0	32.1		3.3	8.1	0.9	18.0	26.7	47.2	8.1	26.9	93.6	63.9	73.1	29.2	24.5	26.9	93.6	94.8	98.0
Head (Calc.) A-E	332.8	100	14.9	6.94	32.7		2.9	18.1	2.5	43.6	18.6	32.4	5.4	100	100	100	100	100	100	100	100	100	100

Stability

	Weight		Assays,%		
	g	%	Cu	Ni	S
Total In All Cycles	333	100.0	14.9	6.94	32.7
Average In Per Cycle	67	20.0			

Total Products Out Per Cycle	Weight		Units out as a % of Units in/Cycle		
	g	Wt %	Cu	Ni	S
Cycle A	44	66.6	48.6	76.8	65.7
Cycle B	66	98.4	95.0	102.0	99.4
Cycle C	61	92.1	87.7	93.3	92.7
Cycle D	70	104.4	107.1	102.1	104.4
Cycle E	63	95.1	88.2	100.4	95.2

Average of B-E	97.5	94.5	99.4	97.9
Average of C-E	97.2	94.3	98.6	97.4
Average of D-E	99.8	97.7	101.2	99.8

Cycle Statistics (Least Squares)

3756	321	4078
27	11	39
215	20	234
70	7	78

Cycle Statistics (Least Squares)

36.4	9.00	45.4
40.0	8.27	48.2
5.5	4.39	9.9

