



**An Investigation into
The Recovery of Copper and Nickel from Composite Samples from the**

PHIKWE-SELEBI DEPOSIT

prepared for

NORTH AMERICAN NICKEL

Project 18559-01 – Final Report
December 13, 2021

NOTES

DISCLAIMER: This document is issued by the Company under its General Conditions of Service accessible at <http://www.sgs.com/en/Terms-and-Conditions.aspx>. Attention is drawn to the limitation of liability, indemnification and jurisdiction issues defined therein. Any holder of this document is advised that information contained hereon reflects the Company's findings at the time of its intervention only and within the limits of Client's instructions, if any. The Company's sole responsibility is to its Client and this document does not exonerate parties to a transaction from exercising all their rights and obligations under the transaction documents. Any unauthorized alteration, forgery or falsification of the content or appearance of this document is unlawful and offenders may be prosecuted to the fullest extent of the law.

WARNING: The sample(s) to which the findings recorded herein (the "Findings") relate was(were) drawn and / or provided by the Client or by a third party acting at the Client's direction. The Findings constitute no warranty of the sample's representativeness of any goods and strictly relate to the sample(s). The Company accepts no liability with regard to the origin or source from which the sample(s) is/are said to be extracted.

ACCREDITATION: SGS Minerals Lakefield is accredited to the requirements of ISO/IEC 17025 for specific tests as listed on our scope of accreditation, including geochemical, mineralogical, and trade mineral tests. To view a list of the accredited methods, please visit the following website and search SGS Lakefield: <http://palcan.scc.ca/SpecsSearch/GLSearchForm.do>.

Table of Contents

Executive Summary	v
Introduction.....	ix
Testwork Summary	1
1. Sample Receipt and Preparation	1
1.1. Individual Samples Preparation	2
1.2. Composites Preparation	3
2. Head Characterization.....	5
2.1. Head Assays.....	5
2.2. Mineralogy	7
2.2.1. Mineral Modals	7
2.2.2. Nickel Department.....	9
2.2.3. Liberation and Association	11
3. Grindability Testwork.....	15
3.1. SMC Test.....	15
3.2. Bond Rod Mill Grindability Test	16
3.3. Bond Ball Mill Grindability Tests	17
3.4. Bond Abrasion Tests	18
4. Flotation Testwork	19
4.1. Test Program Overview	19
4.2. Flowsheet Development	20
4.2.1. Primary Grind	20
4.2.2. Depressants (Na ₂ SO ₃ , DETA).....	21
4.2.3. Alternative Flowsheet Options.....	25
4.2.4. Cu -Ni Separation	29
4.3. Flowsheet Evaluation with P and S Comp.....	31
4.4. Locked Cycle Testing	33
4.4.1. LCT-1 and LCT-2 Test Results	34
4.4.2. LCT-3 Test Results	37
4.5. Detailed Concentrate Assays	41
4.6. Process Mineralogy	42
Conclusions and Recommendations	45
Appendix A – Sample Receipt and Preparation	
Appendix B – Head Characterization	
Appendix C – Grindability Testing	
Appendix D – Batch Flotation Testing	

List of Tables

Table I: Head Assay and Hardness of Testing Samples	v
Table II: LCT-2 and LCT-3 Metallurgical Projection.....	vii
Table 1: As Received Sample Inventory and Weights.....	1
Table 2: Composites Inventory	4
Table 3: Head Assays	6
Table 4: Nickel in Sulphide Distribution	7
Table 5: Mineral Modals of Head Samples	8
Table 6: SMC Test Results	16
Table 7: Bond Rod Mill Grindability Test Results.....	16
Table 8: Bond Ball Mill Grindability Test Results	17
Table 9: Bond Abrasion Test Results	18
Table 10: Summary of Test Objectives.....	19
Table 11: Mineral Composition Summary.....	20
Table 12: Summary of Testing Conditions for tests F-1, F-3, and F-4.	20
Table 13: Summary of Flotation Results of Tests F-1, F-3, and F-4 at Various Primary Grinds	21
Table 14: Summary of Test Conditions of F-2, F-5 to F-12, and F-23.....	23
Table 15: Results Summary of Flotation Tests F-2, F-5 to F-12, and F-23	23
Table 16: Summary of Testing Conditions of F-13, F-20, and F-39	25
Table 17: Results Summary of Flotation Tests F-13, F-20, and F-39.	28
Table 18: Summary of Testing Conditions for F-16 and F-19.....	29
Table 19: Results Summary of Tests F-16 and F-19.....	30
Table 20: Summary of Testing Conditions of F-14, F-15, F-17, F-18, F-21, F-22, and F-37.	32
Table 21: Results Summary of Tests F-14, F-17, and F-21 (S Comp).....	32
Table 22: Results Summary of Tests F-15, F-18, F-22, and F-37 (P Comp).	33
Table 23: LCT-1 Metallurgical Projection (B-F).....	37
Table 24: LCT-2 Metallurgical Projection (D-F)	37
Table 25: Metallurgical Balance of LCT-3.....	38
Table 26: LCT-3 Metallurgical Projection-1 (D).....	39
Table 27: LCT-3 Metallurgical Projection-2 (F-G).....	39
Table 30: Detailed Analysis on LCT-2, LCT-3 Products	42

List of Figures

Figure I: Locked Cycle Tests (LCT-2 and LCT-3) Flotation Flowsheet	viii
Figure 1: Generic Individual Sample Preparation Flowsheet.....	3
Figure 2: Generic Flotation Composite Sample Preparation Flowsheet.....	4
Figure 3: Generic Grindability Composite Sample Preparation Flowsheet	5
Figure 4: Nickel Department of SN Comp.....	9
Figure 5: Nickel Department of P Comp and S Comp	10
Figure 6: Chalcopyrite Association in the Head Samples	12
Figure 7: Pentlandite Association in the Head Samples	13
Figure 8: Pyrrhotite Association in the Head Samples	14
Figure 9: Mineral Release Curve of SN Comp.....	15
Figure 10: RWI of Grind Composites Compared to the SGS Databas.....	16
Figure 11: BWI of Grind Composites Compared to the SGS Database	17
Figure 12: AI of Grind Composites Compared to the SGS Database	18
Figure 13: Flotation Results of F1, F3, and F4.	21
Figure 14: Effect of Na ₂ SO ₃ alone on Pn Selectivity Against Po	24
Figure 15: Effect of Na ₂ SO ₃ and DETA Dosages on Pn Selectivity Against Po	25
Figure 16: Flowsheet of F-13, F-20, and F-39	27
Figure 17: Flowsheet of LCT-2	36
Figure 18: Flowsheet of LCT-3	36
Figure 19: Pentlandite Association of Test F-8 Cu/Ni 1 st Cleaner Tails and Po 1 st Cleaner Tails	43

Executive Summary

Three composite samples (SN Comp, S Comp, P Comp) from the Phikwe – Selebi deposit were prepared for a metallurgical testwork program. The SN Comp represents samples taken from Selebi Main, S Comp represents samples from Selebi North, and the P Comp represents samples from Phikwe South. The historical ore processing in the mine was to produce a bulk flotation concentrate grading at ~3% Cu and ~3% Ni. The main objective of the study was to develop the flowsheet to produce separate marketable copper concentrates (>30% Cu, <1% Ni) and nickel concentrates (>10% Ni) with maximized recoveries. It is notable that this was a quickly executed test program aimed at demonstrating what level of metallurgy may be possible instead of a rigorous redevelopment.

A summary of feed characteristics and the hardness characteristics of the three composite samples is provided in Table I. The copper feed grade varied from 0.42 to 1.90% Cu. The nickel feed grade varied from 0.79 to 1.17% Ni. Nickel sulphide (Ni(s)) assays suggested the majority of the nickel was in sulphide form. Hardness testing revealed the samples to be very soft at SAG mill grind sizes and progressively harder at finer grind sizes. The samples were also slightly abrasive. The sample taken from the Phikwe prospect (P Comp) was a bit harder than the samples taken from Selebi prospect (SN Comp and S Comp).

Table I: Head Assay and Hardness of Testing Samples

Analysis	Unit	SN Comp	S Comp	P Comp
Cu	%	1.07	1.90	0.42
Ni	%	1.17	0.88	0.79
Ni(s)	%	1.12	0.85	0.72
Fe	%	32.3	20.6	20.5
S	%	16.5	11.9	10.4
SMC	A x b	143	140	52.4
	ta	0.99	1.04	0.43
	SCSE (kWh/t)	6.04	6.23	9.45
AI	g	0.18	0.17	0.16
RWI	kWh/t	9.30	8.90	11.4
BWI	kWh/t	12.9	13.7	13.7

A subsample from each of SN Comp, P Comp, and S Comp was submitted for QEMSCAN mineralogy at a grind size of 80% passing 84 µm, 115 µm, 122 µm, respectively. The major sulphide minerals were identified as chalcopyrite, pentlandite, pyrrhotite, with lesser amounts of pyrite. It's worth mentioning that the pyrrhotite content was very high in these samples, ranging from 22 to 37%. About 80% of the nickel was contained in pentlandite, and ~15% of the remaining nickel was mostly hosted by pyrrhotite in solid solution. Minor amounts of nickel ~5% were hosted by non-sulphide gangue minerals.

The chalcopyrite and pyrrhotite were well-liberated, but pentlandite was poorly liberated, at the grind size submitted for mineralogy. The mineralogy results are consistent with what the client expected based on historical data. The use of regrinding is critical to fully liberate pentlandite for maximizing the nickel recovery and grade.

The flotation flowsheet selected is summarized in Figure I. The flowsheet involved grinding to 80% passing ~70 to ~160 μm followed by Cu/Ni bulk flotation to recover the majority of the copper and nickel. Cu/Ni rougher concentrate was reground to a P_{80} of ~30 μm and cleaned once to reject pyrrhotite and non-sulphide gangue. The bulk Cu/Ni cleaner concentrate was further polish ground to clean the mineral surface before undergoing copper-nickel separation. A Po circuit was performed on the Cu/Ni tailings to scavenge residual nickel. A Po rougher was reground to a P_{80} of ~25 μm and cleaned to produce a lower grade nickel concentrate.

Locked cycle tests LCT-1 and LCT-2 were completed to demonstrate the bulk Cu/Ni and Po circuits, while LCT-3 was performed to demonstrate the Cu-Ni separation circuit. The combined LCT-1 & LCT-3 and LCT-2 & LCT-3 results are presented in Table II and Table III, respectively.

Copper was well-behaved achieving 74-78% to the Cu concentrate and 94-95% recovery between the two concentrates. The nickel recovery of the first locked cycle test (LCT-1) was lower than expectations (62%), likely due to the reagent dosages not being appropriate for the coarse primary grind (F_{80} at 150 μm). The second locked cycle test (LCT-2) used a more typical grind size (F_{80} at 100 μm) and showed slightly better nickel recovery (64%).

High grade copper concentrates were achieved at 29-31% Cu. The low nickel content (<1%) in the copper concentrate was also achievable as shown in the combined LCT-1 & LCT-3 results, when strategies such as a higher lime dosage in the grind and lower dosage of PAX in the copper rougher and scavenger stages were applied. Nickel concentrate grades of 10.5-12.0% Ni containing approximately 3% Cu were achieved. Low values of platinum group elements were present in the concentrates with no obvious deleterious elements.

The batch flotation testwork also demonstrated that a low sulphur tailing (<0.5%) were achievable.

Table II: LCT-1 and LCT-3 Metallurgical Projection

Product	Wt	Assays, %			% Distribution		
	%	Cu	Ni	S	Cu	Ni	S
Cu 3rd CI Conc 1-2	2.4	30.9	0.55	34.4	78.8	1.1	5.3
Cu Ro Scav Tail	4.3	3.64	14.5	34.2	15.4	54.2	9.2
Cu/Ni Scalp Tail	11.7	0.16	1.07	32.8	1.9	11.0	24.2
Po 3rd CI Conc	1.7	0.78	5.54	37.1	1.3	8.1	3.9
Po 1st CI Tails	22.2	0.09	1.02	33.6	2.0	19.9	47.0
Po Rougher Tail	57.8	0.01	0.11	2.90	0.6	5.8	10.5
Comb. Ni Conc (Cu Ro Scav Tails + Po 3rd CI Conc)	5.9	2.84	12.0	35.0	16.7	62.3	13.0
Head (Calc.)	100.0	1.00	1.14	15.9	100	100	100
Head (Dir.)		1.07	1.17	16.5			

Table III: LCT-2 and LCT-3 Metallurgical Projection

Product	Wt	Assays, %			% Distribution		
	%	Cu	Ni	S	Cu	Ni	S
Cu 3rd CI Conc 1-2	2.8	28.8	1.92	34.4	74.2	4.6	6.3
Cu Ro Scav Tail	6.6	3.19	11.0	35.0	19.2	59.0	14.2
Cu/Ni Scalp Tail	7.5	0.16	0.86	33.8	1.1	5.2	15.6
Po 3rd CI Conc	0.8	1.66	7.02	36.3	1.3	4.8	1.9
Po 1st CI Tails	23.7	0.18	1.12	34.5	3.8	21.6	50.2
Po Rougher Tail	58.5	0.01	0.10	3.29	0.4	4.8	11.8
Comb. Ni Conc (Cu Ro Scav Tails + Po 3rd CI Conc)	7.4	3.02	10.5	35.1	20.5	63.7	16.1
Head (Calc.)	100.0	1.10	1.23	16.3	100	100	100
Head (Dir.)		1.07	1.17	16.5			

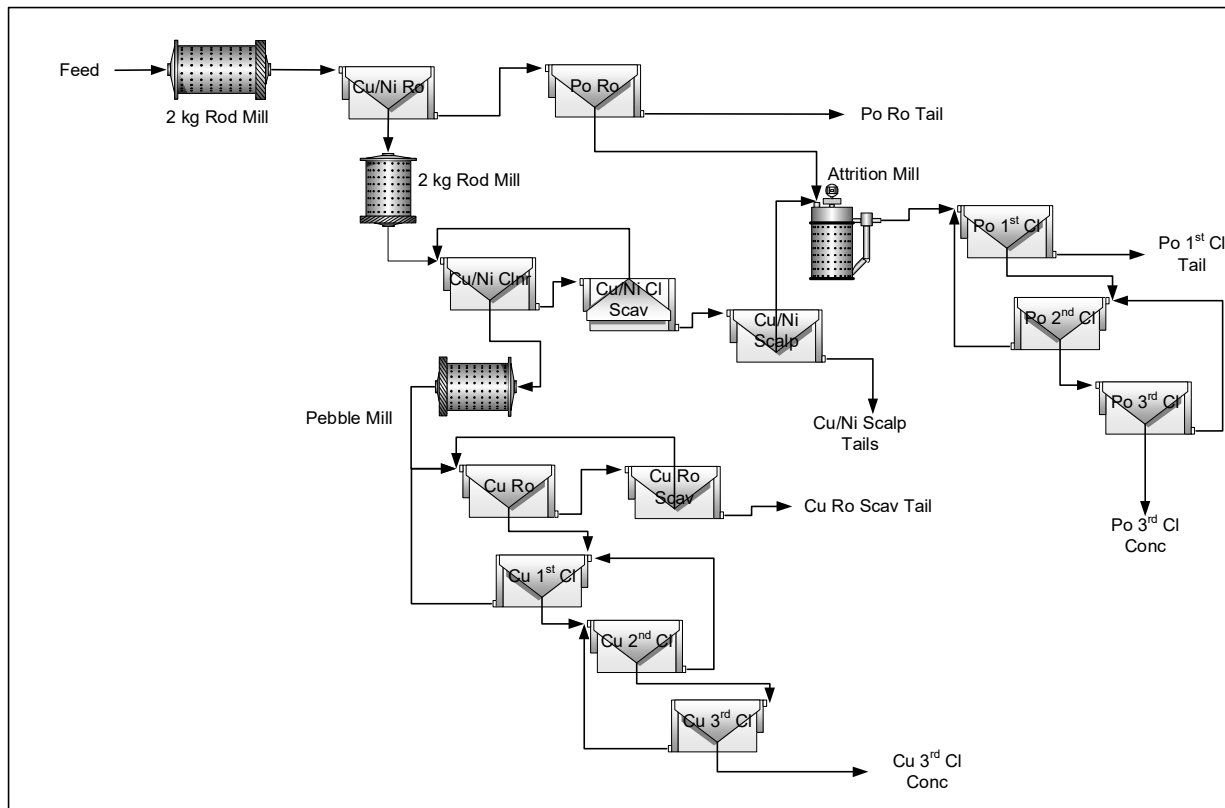

Figure I: Final Locked Cycle Tests (LCT-2 and LCT-3) Flotation Flowsheet

Introduction

Mr. Mike Ounpuu on behalf of North American Nickel contacted SGS Minerals with a request for re-development of the Phikwe-Selebi milling process flowsheet.

The mine originally commenced operations in 1973 and continued operations until 2016, when the mill was shutdown due to poor economic conditions. Head grade in the final 10 years of production was in the range of 0.65% Cu and Ni. The mill generated a low-grade bulk concentrate assaying approximately 3% for each of Cu and Ni, and ~30% for S. The nickel content in pyrrhotite is understood to be 0.5%. Pentlandite occurs as coarse grains as well as exsolution flames in pentlandite, similar to many nickel deposits. Liberation data suggests that 70% of the pentlandite is finer than 40 microns and that non-liberated pentlandite is associated primarily with pyrrhotite. All copper occurs as chalcopyrite, which tends to liberate slightly coarser than pentlandite.

The main objective of the current study is to evaluate a more typical flotation approach to this style of mineralization, with the goal to generate separate marketable Cu and Ni concentrates. The metallurgical targets for this program are to maximize recoveries into concentrates having the following grades:

- A Cu concentrate expected to be approximately 30% Cu and <1% Ni.
- A Ni concentrate grading >10% Ni, but hopefully closer to 12% Ni.

The scope of work included feed characterization (assays and mineralogy), ore hardness evaluations on three samples, and flotation testing.

This report presents the results of the testwork. Results were provided to Mr. Mike Ounpuu, North American Nickel's consultant, as they became available. Progress was discussed with Mr. Ounpuu regularly over the course of the program.

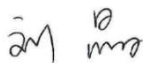

Jing Liu, PhD
Metallurgist



Dan Imeson
Manager – Mineral Processing

*Experimental work by: D. Ariyanayagam, M. Lortie
Report preparation by: J. Liu
Reviewed by: D. Imeson*

Testwork Summary

1. Sample Receipt and Preparation

A shipment of individually marked samples was received at the SGS Lakefield facility on June 4, 2021 from North American Nickel and assigned the internal receipt number 0056-JUN21. The shipment consisted of three skids of 35 pails weighing 719.5 kg in total. Each pail consisted of individual bagged samples with distinct identification numbers marked on the bags. A summary of the thirty-nine (39) as-received samples and the inventoried weights are summarized in Table 1.

Table 1: As Received Sample Inventory and Weights

Sample ID	Area	Zone	Level	As Received Weight (kg)
D15551	Selebi North	South Limb	925mL / 750 Section	13.1
D15552	Selebi North	South Limb	925mL / 750 Section	7.8
D15553	Selebi North	South Limb	925mL / 750 Section	8.5
D15554	Selebi North	South Limb	925mL / 750 Section	15.8
D15555	Selebi North	South Limb	925mL / 750 Section	17.6
D15556	Selebi North	South Limb	925mL / 750 Section	18.3
D15558	Selebi North	South Limb	925mL / 750 Section	14.8
D15559	Selebi North	South Limb	925mL / 750 Section	14.2
D15560	Selebi North	N2 Limb	895m/2100 Section	10.2
D15561	Selebi North	N2 Limb	895m/2100 Section	11.2
D15562	Selebi North	N2 Limb	895m/2100 Section	11.2
D15563	Selebi North	N2 Limb	895m/2100 Section	21.1
D15564	Selebi North	N2 Limb	895m/2100 Section	15.5
D15565	Selebi North	N2 Limb	895m/2100 Section	10.8
D15566	Selebi North	N3 Limb	856m/1600 Section & 796m Stope Access	16.9
D15567	Selebi North	N3 Limb	856m/1600 Section & 796m Stope Access	15.5
D15568	Selebi North	N3 Limb	856m/1600 Section & 796m Stope Access	17.5
D15569	Selebi North	N3 Limb	856m/1600 Section & 796m Stope Access	14.3

Continued on next page....

Table 1: As Received Sample Inventory and Weights (Cont'd)

Sample ID	Area	Zone	Level	As Received Weight (kg)
D15570	Phikwe South	Board/Pillar Stope	870m/3200 Section	21.2
D15571	Phikwe South	Board/Pillar Stope	870m/3200 Section	20.8
D15572	Phikwe South	Board/Pillar Stope	870m/3200 Section	21.7
D15573	Phikwe South	Board/Pillar Stope	870m/3200 Section	21.8
D15581	Phikwe South	Board/Pillar Stope	870m/3200 Section	8.0
D15574	Phikwe South	Board/Pillar Stope	870m/3200 Section	15.6
D15575	Phikwe South	Board/Pillar Stope	870m/3200 Section	17.8
D15576	Phikwe South	Board/Pillar Stope	870m/3200 Section	6.0
D15577	Phikwe South	Board/Pillar Stope	870m/3200 Section	10.2
D15578	Selebi Main	Sub Level Open Stop (SLOS)	850mL	21.3
D15579	Selebi Main	Sub Level Open Stop (SLOS)	850mL	20.1
D15580	Selebi Main	Sub Level Open Stop (SLOS)	850mL	21.6
D15582	Selebi Main	Sub Level Open Stop (SLOS)	850mL	21.1
D15583	Selebi Main	Sub Level Open Stop (SLOS)	850mL	20.9
D15584	Selebi Main	Sub Level Open Stop (SLOS)	850mL	20.9
D15585	Selebi Main	Sub Level Open Stop (SLOS)	850mL	17.4
D15586	Selebi Main	Sub Level Open Stop (SLOS)	850mL	21.7
D15587	Selebi Main	Sub Level Open Stop (SLOS)	850mL	20.2
D15588	Selebi Main	Sub Level Open Stop (SLOS)	850mL	19.9
D15589	Selebi Main	Sub Level Open Stop (SLOS)	850mL	20.3
D15590	Selebi Main	Sub Level Open Stop (SLOS)	850mL	13.6

1.1. Individual Samples Preparation

All thirty-nine (39) of the samples were prepared for the test program. Each sample was crushed to nominal 1.5" (or 40 mm). One quarter was split for grindability composite makeup, the remaining three quarters were crushed to nominal 6 mesh (or 3.4 mm). Approximately 100-200 g was also split and pulverized for Cu, Ni, and S assays. The remaining sample was stored for flotation composite makeup. The generic sample preparation flowsheet applied to each of the tested samples is illustrated in Figure 1.

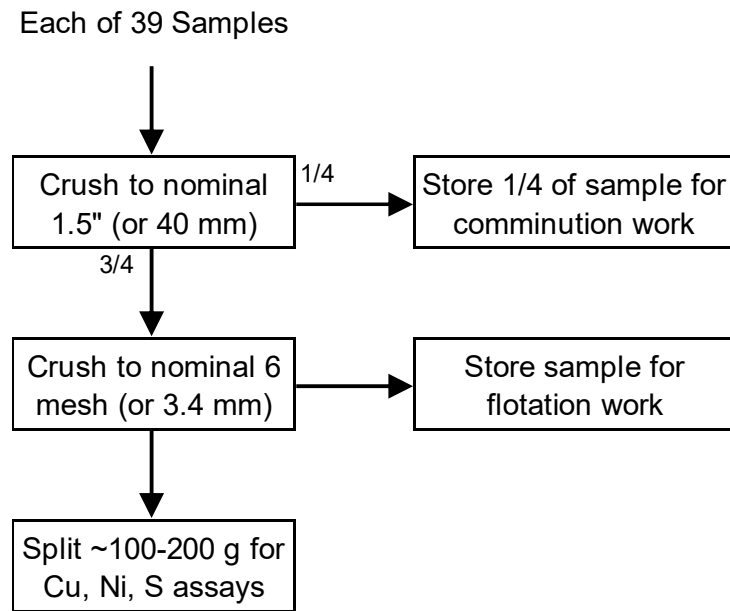

Figure 1: Generic Individual Sample Preparation Flowsheet

1.2. Composites Preparation

Three composites representing samples taken from three areas were prepared - Selebi North (SN Comp), Selebi Main (S Comp), and Phikwe South (P Comp), following the instruction provided by the client.

Figure 2 and Figure 3 depict the generic sample preparation flowsheet for the flotation composites and grindability composites, respectively. For the flotation composite preparation, the selected individual samples (nominal 6 mesh) were composited to target typical resource average head grades at the instruction of the client. Once blended, about 40-60 kg of subsample was taken and stage-crushed to -10 mesh (or 1.7 mm). They were rotary split into 2 kg test charges. Approximately 100-200 g was also split and pulverized for Cu, Ni, Ni(S), S, and ICP Scan assays. The remaining samples were stored for potential future testwork.

For the grindability composite preparation, the selected samples (nominal 1.5") were composited in the same ratio as the flotation composites. About 25 kg was taken for the SMC test, about 5 kg was used for AI test. The remainder of the grindability composite combined with the SMC reject was stage-crushed to -1/2" (or 12.7 mm). A 15 kg subsample was submitted for the Bond rod mill grindability test (RWI). About 10 kg was stage-crushed to -6 mesh (or 3.35 mm) and submitted for the Bond ball mill grindability test (BWI).

The weights of the flotation composites and grindability composites are summarized in Table 2. Full details of the sample preparations are provided in the appendix (Appendix A).

Table 2: Composites Inventory

Comp ID	Comp Abbr. ID	Weights, kg	
		Float Comp	Grind Comp
Selebi North	SN Comp	121.0	43.2
Selebi Main	S Comp	97.6	35.7
Phikwe South	P Comp	76.8	28.3

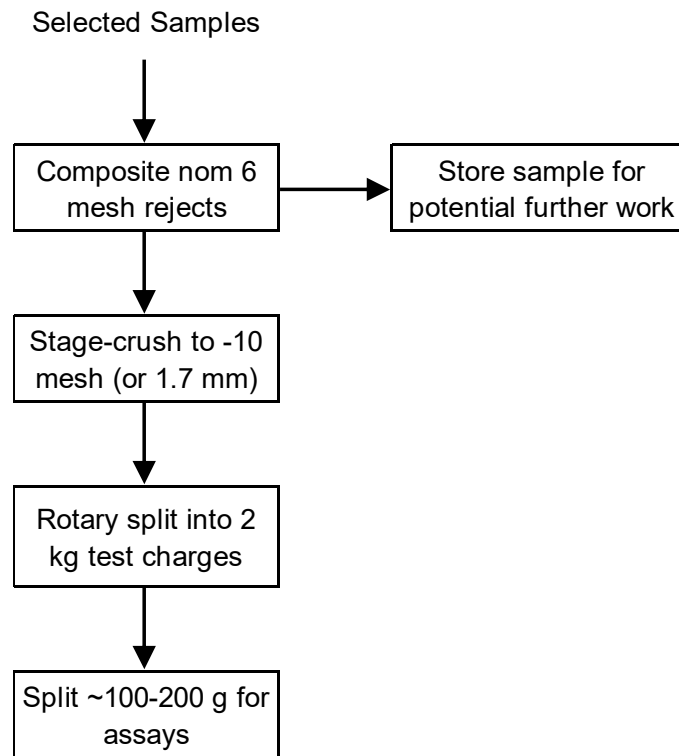
**Figure 2: Generic Flotation Composite Sample Preparation Flowsheet**

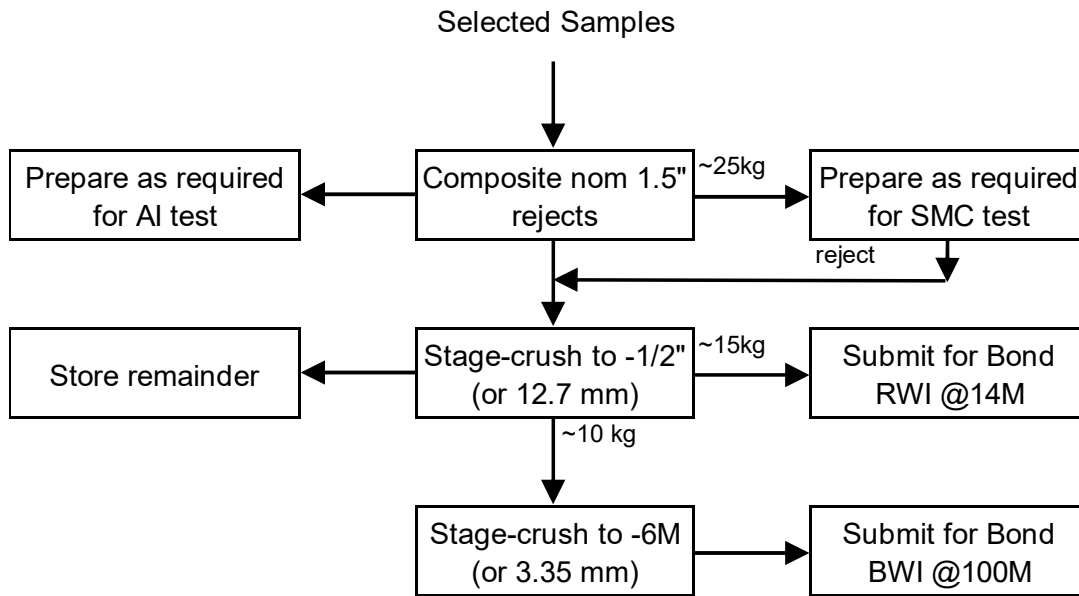

Figure 3: Generic Grindability Composite Sample Preparation Flowsheet

2. Head Characterization

2.1. Head Assays

A subsample of each of the thirty-nine (39) individual samples was submitted for assays, which included copper, nickel, and sulphur. The results are provided in Appendix B.

A subsample of each of the three flotation composites was submitted for head assays, which included copper, nickel, nickel as sulphide (NiS), sulphur, gold, platinum, palladium, rhodium, mercury, and ICP-MS Scan analysis. Another subsample was submitted to analyze the nickel in the methanol bromine leach residue. The head assays are summarized in Table 3.

The distribution of the nickel in sulphide was calculated with the following two methods, results are shown in Table 4.

- Method A: Based on the Ni(s) and the total nickel direct assays, the difference of these two was calculated to be the nickel in non-sulphide minerals.
- Method B: Based on the Ni(s) and Ni in leach residue, calculate the total nickel.

All the sulphide minerals were assumed to be leached out in Method B, thus mass losses in the residue at 43%, 25%, and 32% for SN Comp, P Comp, and S Comp, respectively, as determined by mineralogy analysis. The nickel in sulphide distribution calculated from both methods were similar. The nickel as sulphide accounted for ~95% for the SN Comp, 93% for the P Comp, and ~96% for the S Comp.

Table 3: Head Assays

Analyte	Unit	SN Comp	P Comp	S Comp
Cu	%	1.07	0.42	1.90
Ni	%	1.17	0.79	0.88
Ni(s)	%	1.12	0.72	0.85
Fe	%	32.3	20.5	20.6
S	%	16.5	10.4	11.9
Au	g/t	< 0.02	< 0.02	0.18
Pt	g/t	0.12	< 0.02	0.06
Pd	g/t	0.05	0.02	0.08
Rh	g/t	< 0.02	< 0.02	< 0.02
Hg	g/t	< 0.3	< 0.3	< 0.3
Ag	g/t	3.1	0.9	7.1
Al	g/t	41600	58400	58400
As	g/t	< 10	< 10	< 10
Ba	g/t	83.6	174	95.1
Be	g/t	0.46	1.7	0.66
Bi	g/t	2.3	2.7	6.1
Ca	g/t	24800	27000	36700
Cd	g/t	1.8	0.4	3.1
Co	g/t	657	435	437
Cr	g/t	140	224	142
Cu	g/t	10400	4100	19100
K	g/t	3740	14200	5070
Li	g/t	< 30	< 30	< 30
Mg	g/t	23200	33900	42400
Mn	g/t	760	757	916
Mo	g/t	2.4	12.4	3.2
Na	g/t	10500	14100	11400
Ni	g/t	12100	8080	9220
P	g/t	< 200	234	216
Pb	g/t	21.4	16.9	8.5
Sb	g/t	< 0.8	< 0.8	< 0.8
Se	g/t	22	13	31
Sn	g/t	3	5	6
Sr	g/t	57.9	48.1	47.1
Ti	g/t	1290	1960	1360
Tl	g/t	< 0.4	1	< 0.4
U	g/t	2.5	5.9	3.7
V	g/t	119	97	51
Y	g/t	7.2	17.2	10.2
Zn	g/t	86	80	135

Table 4: Nickel in Sulphide Distribution

	Element	Ni or Ni(s) Assay, %			Ni (S) Distribution		
		SN Comp	P Comp	S Comp	SN Comp	P Comp	S Comp
Method A	Ni(s)	1.12	0.72	0.85	95.7	90.5	96.1
	Ni(s) - Repeat	1.08	0.74	0.87	92.3	93.7	98.9
	Ni(s) - Average	1.10	0.73	0.86	94.0	92.1	97.5
Method B	Ni(s) - Average	1.10	0.73	0.86	94.6	93.7	93.8
	Ni in Leach Residue	0.11	0.07	0.08	5.39	6.28	6.17
	Ni Total calc.	1.16	0.78	0.91	100	100	100
	Ni Total dir.	1.17	0.79	0.88			

2.2. Mineralogy

The subsample used for the mineralogy study was taken from the product of the grind calibration test at 30 minutes in a 2 kg rod mill. The K_{80} of SN Comp, P Comp, and S Comp for 30 minutes of grinding were 84 μm , 115 μm , and 122 μm , respectively. The SN Comp sample was screened into four size fractions, i.e., +106 μm , -106/+53 μm , -53/+20 μm , and -20 μm . The P Comp and S Comp was submitted as received, unsized. Each size fraction or sample as-received was assayed and mounted into graphite-impregnated polished sections.

The following sections briefly discuss mineral modals, nickel deportment, and liberation and association of the main sulphide minerals. Further information can be found in Appendix B.

2.2.1. Mineral Modals

The mineral modals are summarized in Table 5. Major sulphide minerals included chalcopyrite (the only copper mineral), pentlandite (the primary nickel carrier), and pyrrhotite, with lesser quantities of pyrite. The non-sulfide minerals mainly included amphibole/pyroxene, plagioclase, quartz, iron oxide, and chlorite/clays.

Table 5: Mineral Modals of Head Samples

Sample ID	SN Comp	P Comp	S Comp	
K₈₀, μm	84	115	122	
Mineral Mass (%)	Pyrrhotite	37.0	22.1	23.9
	Chalcopyrite	3.10	1.26	5.97
	Pentlandite	3.13	1.97	2.47
	Pyrite/Marcasite	0.12	2.31	0.22
	Other Sulphides	0.04	0.03	0.04
	Fe-Oxides	6.25	0.07	1.59
	Other Oxides	0.15	0.04	0.05
	Chlorite/Clays	7.90	8.82	10.3
	Biotite	1.77	14.8	3.16
	Talc	0.17	0.12	0.13
	Quartz	7.71	11.2	7.31
	Plagioclase	10.2	16.4	10.7
	Amphibole/Pyroxene	20.6	19.1	33.0
	K-Feldspar	0.65	1.22	0.38
	Epidote	0.56	0.11	0.31
	Titanite/sphene	0.10	0.06	0.01
	Other Silicates	0.34	0.07	0.19
	Carbonates	0.02	0.09	0.13
	Apatite	0.11	0.19	0.09
	Other	0.06	0.05	0.07
Total	100	100	100	

2.2.2. Nickel Department

Pentlandite hosts the majority of the nickel. Pyrrhotite and silicates gangue minerals are believed to contain low to very low level of nickel in solid-solution based on historical data, at 0.5% and 0.026% Ni, respectively. Due to the abundance of pyrrhotite, the proportion of nickel in these minerals could be significant: ~15% for SN Comp, ~14% for P Comp, and ~12% for S Comp. The nickel distribution in sulphides other than pentlandite and pyrrhotite (i.e., millerite) was fairly low. The department of sulphide nickel is summarized in Figure 4 and Figure 5.

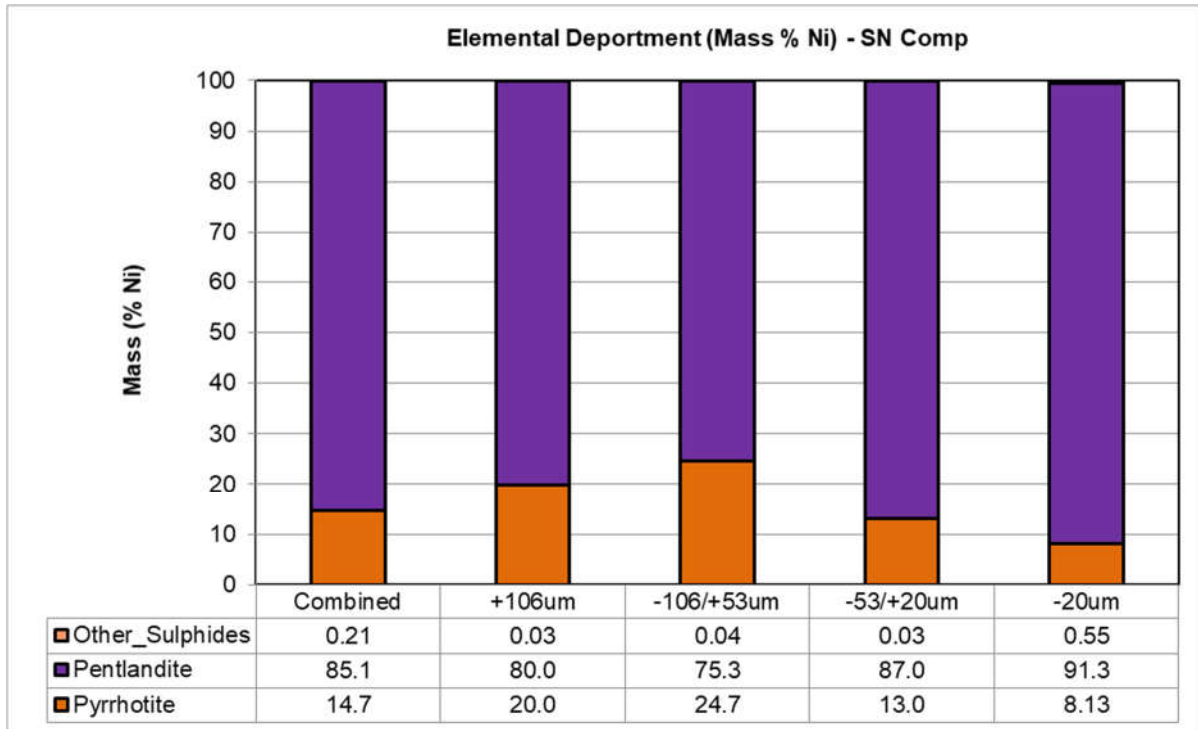

Figure 4: Sulphide Nickel Department of SN Comp

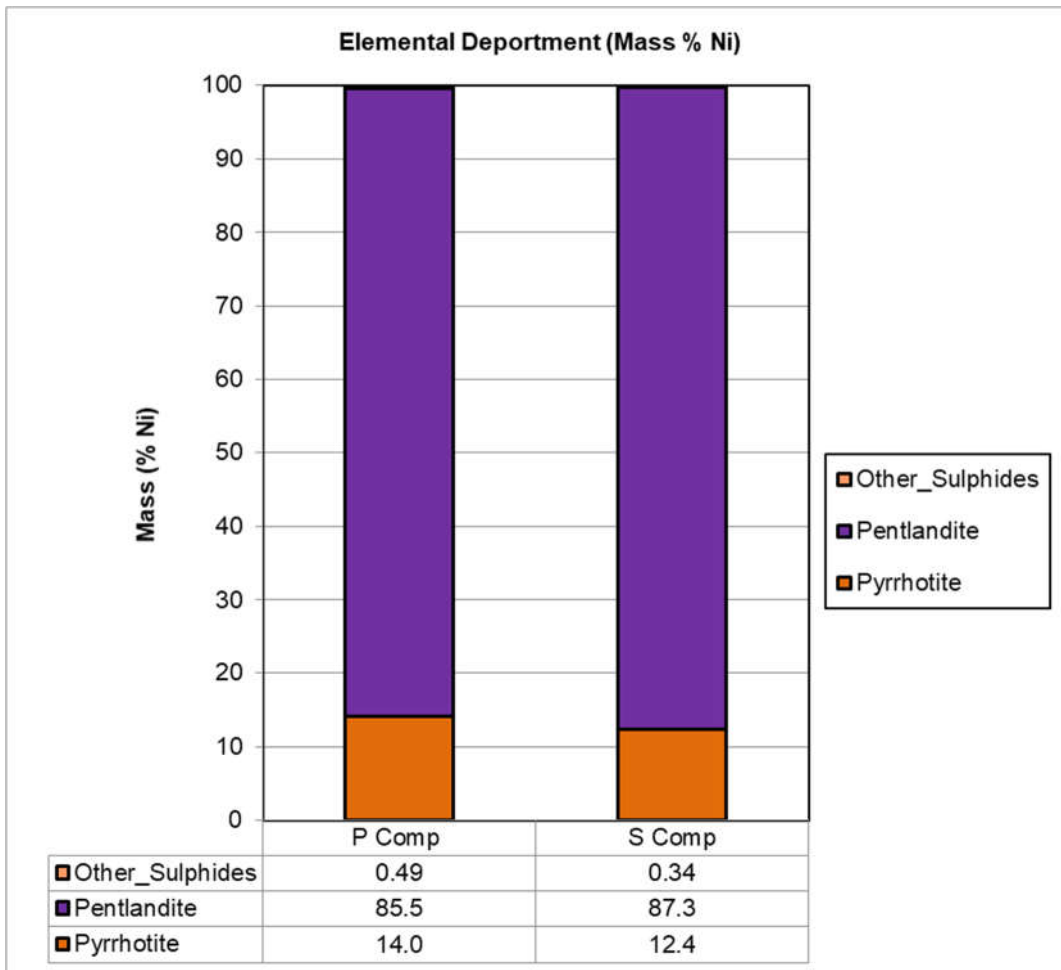

Figure 5: Nickel Department of P Comp and S Comp

2.2.3. Liberation and Association

The liberation classes of the minerals present in the ore have been defined as follows:

- Free: A mineral with >95% area percent of particle
- Liberated: A mineral with <95 but ≥80% area percent of particle
- Middlings: A mineral with <80% but ≥50% area percent of particle
- Sub-Middling: A mineral with <50% but ≥20% area percent of particle
- Locked: A mineral with <20% area percent of particle



The chalcopyrite was well-liberated for all three samples submitted, 87% free and liberated for the SN Comp at a K_{80} of 84 μm , ~82% for the P Comp at a K_{80} of 115 μm , 94% for the S Comp at a K_{80} of 122 μm .

The liberation of pentlandite was poor at a K_{80} of ~90-120 μm for all three samples, ~48-65%. The portion of free and liberated pentlandite for the SN Comp improved to 83% at -20 μm . This indicates a fine regrind is likely required.

The pyrrhotite were found to be quite well-liberated for all three samples submitted, 96% free and liberated for the SN Comp and S Comp, and ~87% for the P Comp.

The summary charts for the association of the chalcopyrite, pentlandite, and pyrrhotite are presented in Figure 6, Figure 7, and Figure 8, respectively. Additional information on liberation can be found in Appendix B. The non-liberated pentlandite was mainly associated with pyrrhotite, ~30% of the non-liberated pentlandite grains being associated with pyrrhotite. Regrinding could be useful to liberate pentlandite from pyrrhotite.

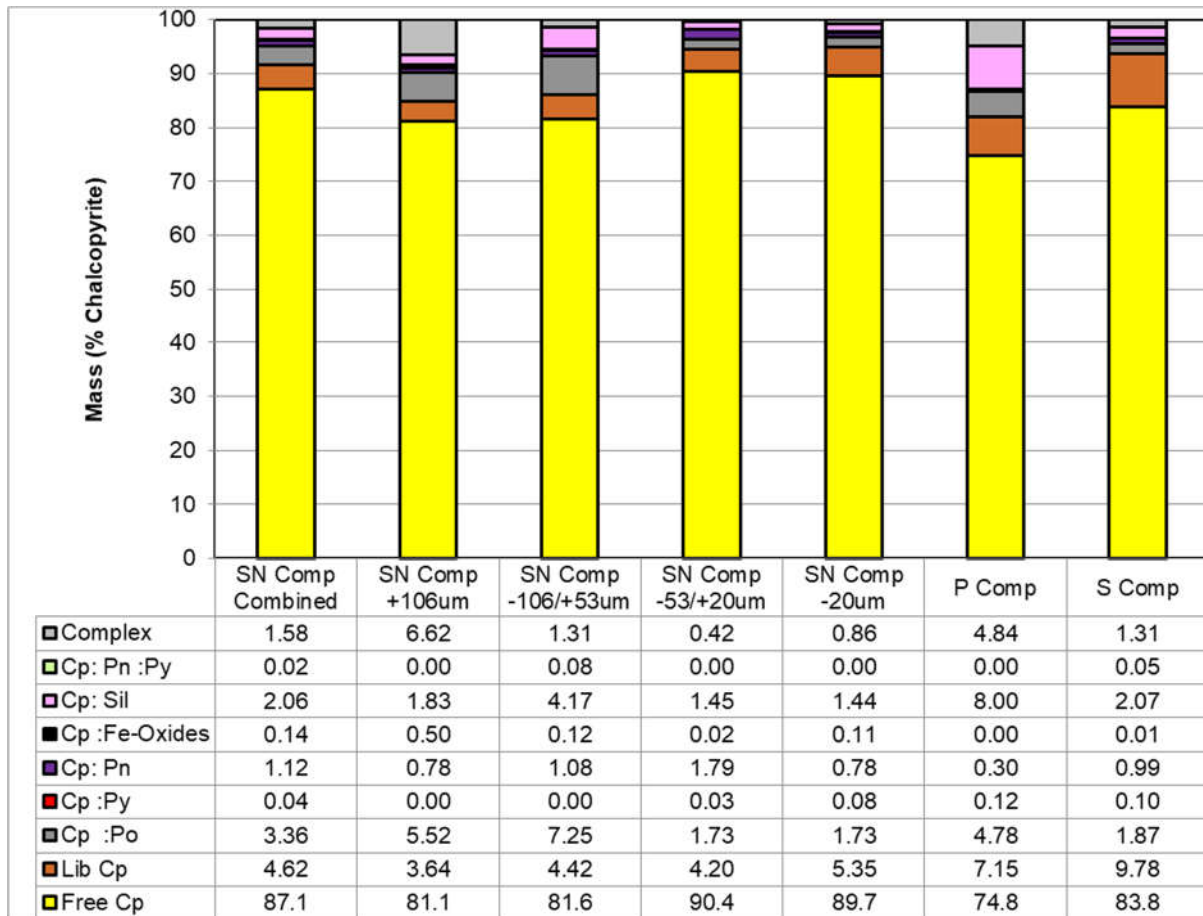

Figure 6: Chalcopyrite Association in the Head Samples

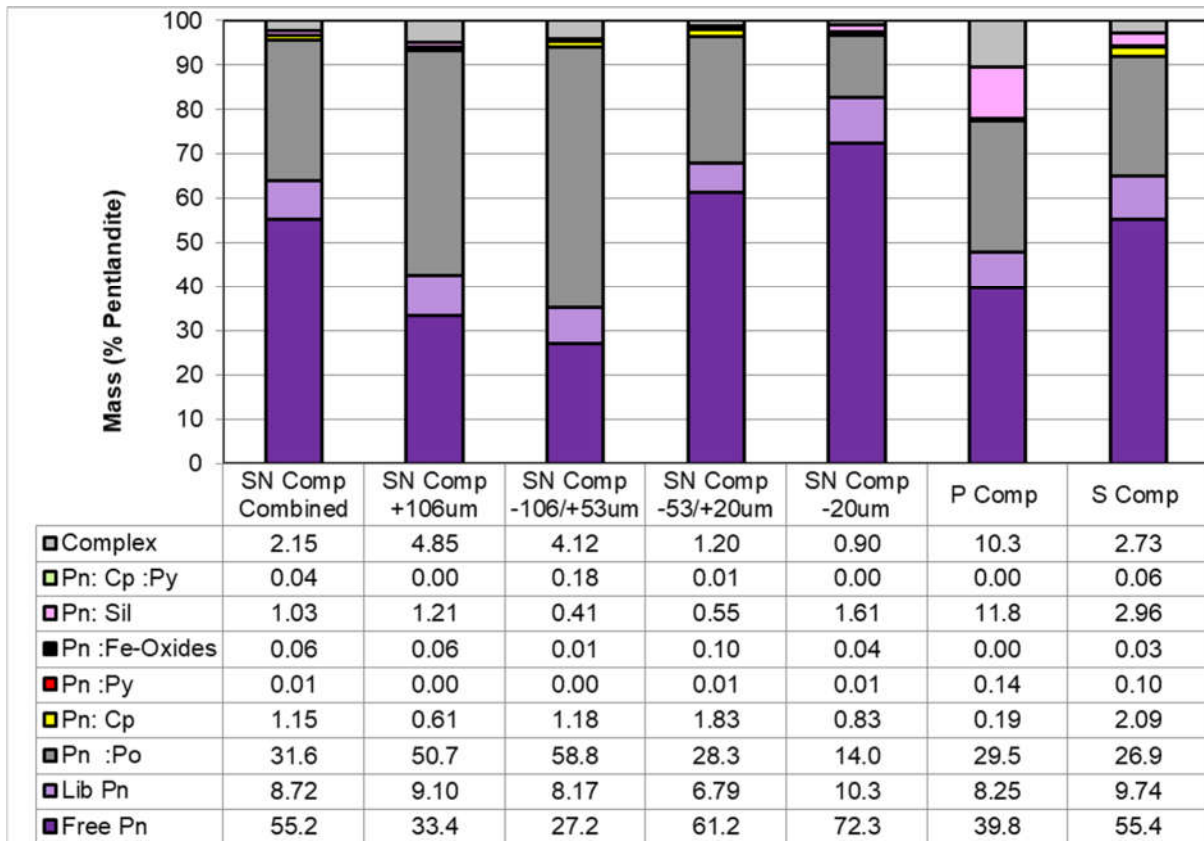

Figure 7: Pentlandite Association in the Head Samples

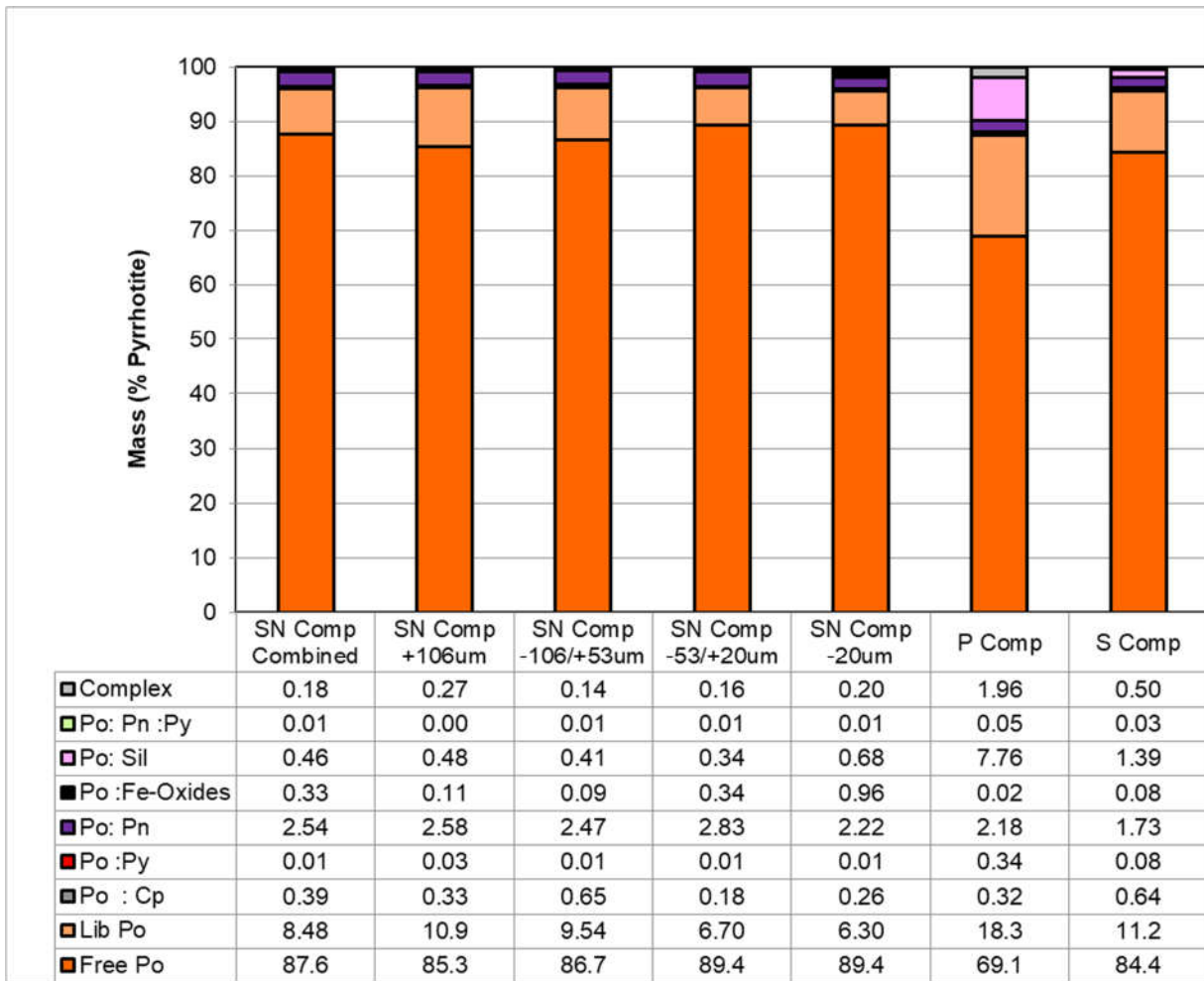

Figure 8: Pyrrhotite Association in the Head Samples

The effect of grind size on liberation of the major sulphide minerals is demonstrated by the mineral release curves in Figure 9, which shows that a primary grind at approximately 100 µm might be reasonable, but a fine regrind to ~20 µm is necessary for good nickel recovery/grade.

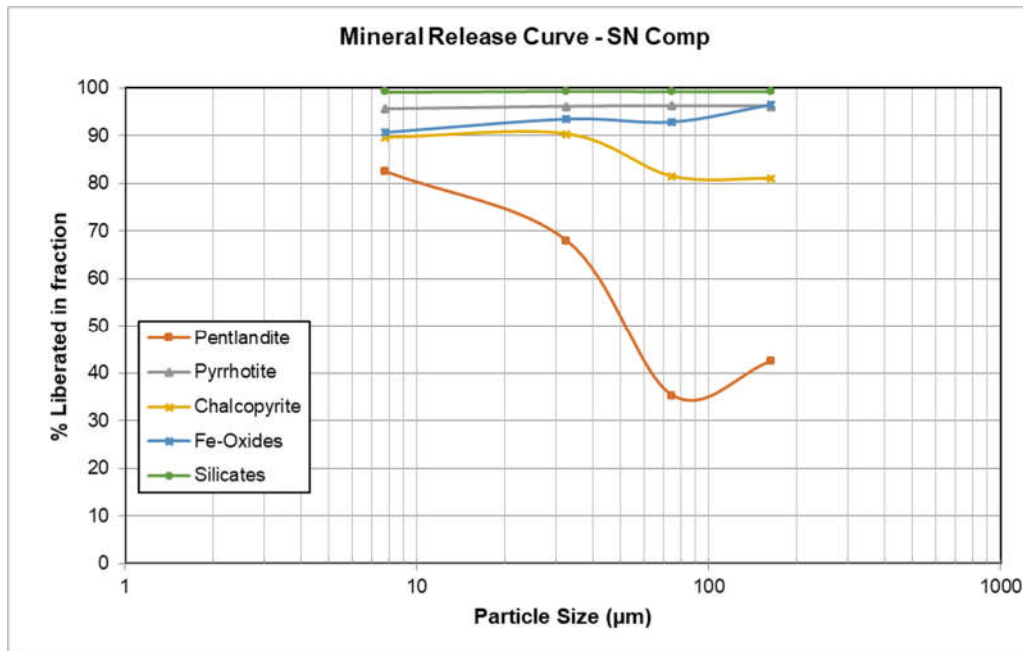

Figure 9: Mineral Release Curve of SN Comp

3. Grindability Testwork

Each of the three grind composites were submitted for the SMC test, Bond rod mill grindability test, Bond abrasion test, and Bond ball mill grindability test. Results are briefly summarized below. The complete test details are provided in Appendix C.

3.1. SMC Test

The SMC test is an abbreviated version of the standard JK drop-weight test performed on 100 rocks from a single size fraction (-31.5+26.5 mm in this case). The SMC test was performed on the three grind composite samples. The test results are summarized in Table 6 and detailed in the JKTech report which is appended (Appendix C), along with the test procedure, calibration, and test details.

The SMC test results are preferably calibrated against reference samples submitted to the standard JK drop-weight test (DWT) in order to consider the natural 'gradient of hardness' by size, which can widely vary from one ore to another. The SMC results were calibrated against the JK database average, as no standard DWT tests were performed as part of this project.

The samples were categorized as very soft (SN Comp and S Comp) to medium (P Comp) in terms of resistance to impact breakage, with A x b values ranging from 143 to 52.4.

The relative densities varied from 3.13 to 3.73, with the latter value being associated with SN Comp.

Table 6: SMC Test Results

Sample Name	A	b	A x b	Hardness Percentile	t_a^1	DWI (kWh/m ³)	M _{ia} (kWh/t)	M _{ih} (kWh/t)	M _{ic} (kWh/t)	SCSE (kWh/t)	Relative Density
SN Comp	77.7	1.84	143	7	0.99	2.6	6.6	4.1	2.1	6.0	3.73
S Comp	74.3	1.89	140	7	1.04	2.5	6.8	4.1	2.1	6.2	3.49
P Comp	68.1	0.77	52.4	44	0.43	6.0	15.3	11.1	5.7	9.5	3.13

¹The t_a value reported as part of the SMC procedure is an estimate

3.2. Bond Rod Mill Grindability Test

Bond rod mill grindability tests were performed at 14 mesh of grind on received samples. The test results are summarized in Table 7, and compared to the SGS database in Figure 10. The rod mill work indices (RWI's) for grind composites were similar for the two composites from Selebi, ~9 kWh/t, and slightly harder for the Phikwe sample (P Comp), at 11.4 kWh/t. The samples were categorized as soft to very soft.

Table 7: Bond Rod Mill Grindability Test Results

Sample Name	Mesh of Grind	F ₈₀ (µm)	P ₈₀ (µm)	Gram per Revolution	Work Index (kWh/t)	Hardness Percentile
SN Comp	14	9,679	887	18.3	9.3	9
S Comp	14	9,147	884	20.0	8.9	7
P Comp	14	9,744	849	12.5	11.4	20

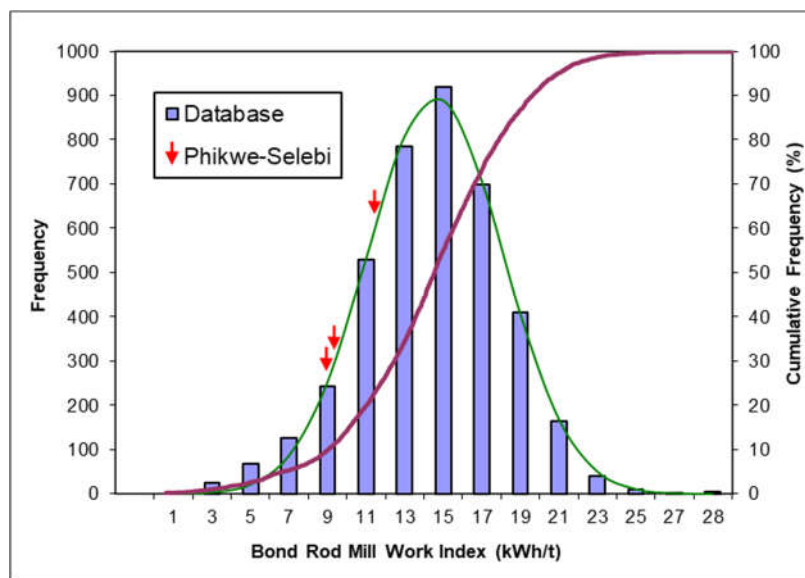

Figure 10: RWI of Grind Composites Compared to the SGS Database

3.3. Bond Ball Mill Grindability Tests

Bond ball mill grindability tests were performed at 48 mesh of grind on received samples. The test results are summarized in Table 8, and compared to the SGS database in Figure 11. The test details are provided in Appendix C. The ball mill work indices (BWI's) for grind composites were similar, ranging from 12.9 to 13.7 kWh/t. SN Comp was categorized as moderately soft, and S and P Comp were categorized as medium.

Table 8: Bond Ball Mill Grindability Test Results

Sample Name	Mesh of Grind	F ₈₀ (µm)	P ₈₀ (µm)	Gram per Revolution	Work Index (kWh/t)	Hardness Percentile
SN Comp	100	2,129	123	1.98	12.9	34
S Comp	100	2,035	126	1.89	13.7	43
P Comp	100	2,207	129	1.91	13.7	42

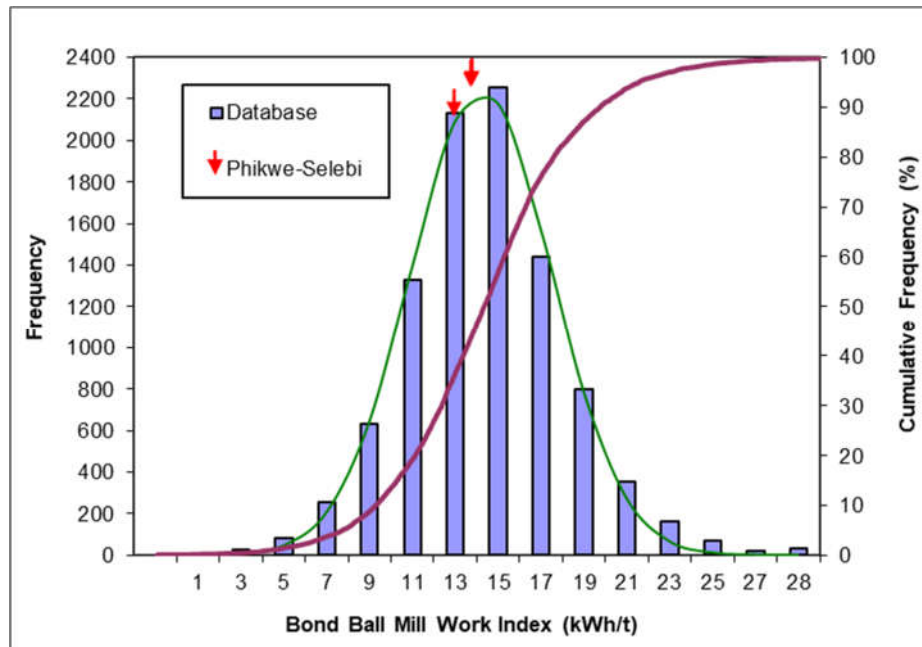

Figure 11: BWI of Grind Composites Compared to the SGS Database

3.4. Bond Abrasion Tests

Bond abrasion tests were performed on 12.7 to 19 mm (1/2" to 3/4") fractions of the as-received crushed samples. The test results are summarized in Table 9 and compared to the SGS database in Figure 12. The samples were characterized as slightly abrasive, the abrasion index (AI) ranging from 0.157 to 0.179 g.

Table 9: Bond Abrasion Test Results

Sample Name	AI (g)	Percentile of Abrasivity
SN Comp	0.179	32
S Comp	0.168	30
P Comp	0.157	28

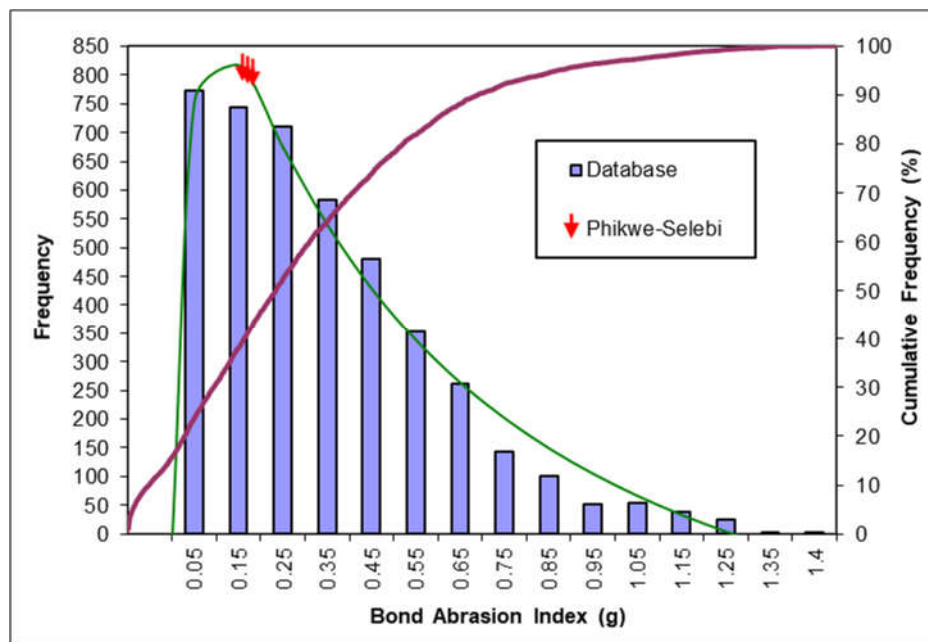

Figure 12: AI of Grind Composites Compared to the SGS Database

4. Flotation Testwork

4.1. Test Program Overview

The main objective of the flotation test program was to develop a flowsheet that can produce separate marketable copper and nickel concentrates by applying typical conditions used for a Cu/Ni project. The SN Comp was the main sample used for flowsheet development, followed by confirmatory tests using the P Comp and S Comp. Locked cycle tests were conducted on SN Comp sample.

A summary of test objectives is given in Table 10.

Table 10: Summary of Test Objectives

Test ID	Test Objective
SN Comp	
F1	Conduct initial rougher kinetics test, at K_{80} of 100 μm
F2	Based on F1, conduct initial open-circuit cleaning test
F3	Conduct rougher kinetics test, at K_{80} of ~150 μm
F4	Conduct rougher kinetics test, at K_{80} of ~75 μm
F5	Similar to F2, test Po depressants Na ₂ SO ₃ and DETA, 500/150g/t
F6	Similar to F2, test Po depressants Na ₂ SO ₃ only, 500g/t
F7	Similar to F5, with half Na ₂ SO ₃ and DETA, 250/75 g/t
F8	Similar to F5, with less Na ₂ SO ₃ and DETA, 100/50 g/t
F9	Similar to F5, with less Na ₂ SO ₃ and DETA, 100/25 g/t
F10	Similar to F9, with 100/10 g/t Na ₂ SO ₃ and DETA
F11	Similar to F10, with coarse primary grind (K_{80} = 150 μm) and finer Po regrind
F12	Similar to F9, with 0/25 g/t Na ₂ SO ₃ and DETA
F13	Based on F9, with bulk Ro Conc regrind, followed with 2nd regrind on the cleaner tails
F16	Similar to F9, with no Na ₂ SO ₃ and 25 g/t DETA. Full Cleaner test with CuSEP
F19	Similar to F16, with polish grind on CuSEP, clean Po Ro Conc and Cu/Ni Cl tails separately
F20	Similar to F19, with coarse primary grind (K_{80} =150 μm)
F23	Based on F2, no DETA in the regrind.
F39	Evaluate flowsheet with Cu/Ni Cl Scav Tails regrind with Po Ro Conc
S Comp	
F14	Conduct rougher kinetics test on S Comp, target K_{80} ~150 μm
F17	Similar to F9, 1st Cleaner Kinetics on S Comp
F21	Similar to F16/F19, Using S Comp
P Comp	
F15	Conduct rougher kinetics test on P Comp, target K_{80} ~150 μm
F18	Similar to F9, 1st Cleaner Kinetics on P Comp
F22	Similar to F16/F19, Using P Comp
F37	Evaluate flowsheet with Cu/Ni Cl Scav Tails regrind with Po Ro Conc

All flotation tests were performed using laboratory Denver flotation cells applying industry standard flotation practices. The collector used in the program was Potassium Amyl Xanthate (PAX). Lime was used as the pH modifier and MIBC was used as the frother. Sodium sulphite (Na₂SO₃) and Diethylenetriamine (DETA) were used as the depressants.

Test products were filtered, dried, weighed, and submitted for Cu, Ni, and S assays. Particle sieve analyses were completed to size coarser products (Flotation Feed or Rougher / Scavenger tailings), while a Malvern Mastersizer was used to size finer products (regrind product or Cleaner tailings).

Flotation test details are provided in the appendix (Appendix D). A summary of test results is provided in the following sections.

The typical flowsheet was to recover most of the chalcopyrite (Cp) and pentlandite (Pn), i.e., the main copper and nickel minerals, during the Cu/Ni Rougher stage, while minimizing the recovery of pyrrhotite (Po). The remaining pentlandite would be recovered during the Po Rougher stage, with higher pyrrhotite recoveries producing a low-grade concentrate. The Cu/Ni Rougher Concentrate and Po Rougher Concentrate were re-ground and cleaned separately. The Cu - Ni separation would be performed on the Cu/Ni Cleaner Concentrate, to produce a copper concentrate and a nickel concentrate (Cu Tailings).

The flotation test results include the calculation of mineral contents from the elemental assays. The mineral composition used for these calculations are summarized in Table 11.

Table 11: Mineral Composition Summary

	Cu	Ni	S	Other
Cp	34.5	0.0	35.0	30.5
Pn	0.0	36.0	33.0	31.0
Po	0.0	0.5	38.5	61.0
Ga*	0.0	0.0	0.0	100.0

Ga* represents the silicate gangue minerals

4.2. Flowsheet Development

4.2.1. Primary Grind

Three rougher flotation kinetics tests (F-1, F-3, F-4) were performed, at various primary grind sizes (F_{80} of 71 μm , 100 μm , 162 μm), which included rougher flotation of a Cu/Ni concentrate and Po Rougher flotation circuits. The testing conditions are summarized in Table 12.

Table 12: Summary of Testing Conditions for tests F-1, F-3, and F-4.

Test ID	Cu/Ni Roughers				Po Roughers			
	F_{80} (μm)	PAX g/t	pH	Residence Time, min	CuSO_4 g/t	PAX g/t	pH	Residence Time, min
F-1	100	15	9.2-9.4	5	50	50	natural	13
F-3	162	15	9.0-9.3	5	0	15	natural	13
F-4	71	15	9.0-9.2	5	0	15	natural	13

The flotation results of the rougher kinetics tests are summarized in Table 13 and depicted in Figure 13.

The copper and nickel recoveries of Cu/Ni Rougher Concentrates 1-3 in test F-1, at F_{80} of 100 μm , were the highest, at 99% Cu and 82% Ni, with a bit higher mass pull (26% vs 22-23% in F-3 and F-4). However, the copper or nickel recoveries against the mass pull as well as the pentlandite vs pyrrhotite recoveries were similar in all three tests. It is possible that all three grind sizes could achieve similar metallurgical targets with proper reagent schemes. Due to the tight project timeline, test F-1 at F_{80} of 100 μm with the best recoveries was selected as the baseline for most of the subsequent tests.

Table 13: Summary of Flotation Results of Tests F-1, F-3, and F-4 at Various Primary Grinds

Test ID	F_{80} (μm)	Product	Wt %	Assays, %						Distribution, %					
				Cu	Ni	S	Cp	Pn	Po	Cu	Ni	S	Cp	Pn	Po
F-1	100	Cu/Ni Ro Conc 1-3	25.9	3.97	3.68	34.5	11.5	9.24	71.2	98.9	82.0	52.7	98.9	90.2	47.2
		Po Ro Conc 1-3	23.1	0.04	0.81	33.7	0.11	1.05	86.4	0.9	16.2	46.0	0.9	9.2	51.3
		Mag Scav Conc	7.4	0.01	0.05	1.05	0.01	0.04	2.68	0.0	0.3	0.5	0.0	0.1	0.5
		Mag Scav Tails	43.6	0.01	0.04	0.35	0.01	0.03	0.87	0.2	1.5	0.9	0.2	0.5	1.0
F-3	162	Cu/Ni Ro Conc 1-3	22.3	4.45	3.95	34.3	12.9	10.0	68.7	97.5	76.2	45.5	97.5	84.8	39.6
		Po Ro Conc 1-3	14.7	0.09	1.10	35.2	0.25	1.80	89.7	1.2	14.0	30.8	1.2	10.1	34.1
		Po Ro Tail	63.0	0.02	0.18	6.30	0.06	0.22	16.1	1.2	9.8	23.7	1.2	5.2	26.3
F-4	71	Cu/Ni Ro Conc 1-3	22.9	4.19	3.94	32.7	12.2	10.0	65.3	95.5	78.2	45.5	95.5	87.0	39.5
		Po Ro Conc 1-3	19.2	0.16	0.92	33.3	0.47	1.36	85.0	3.1	15.3	38.9	3.1	9.9	43.1
		Po Ro Tail	57.8	0.02	0.13	4.44	0.07	0.14	11.3	1.4	6.5	15.6	1.4	3.1	17.3

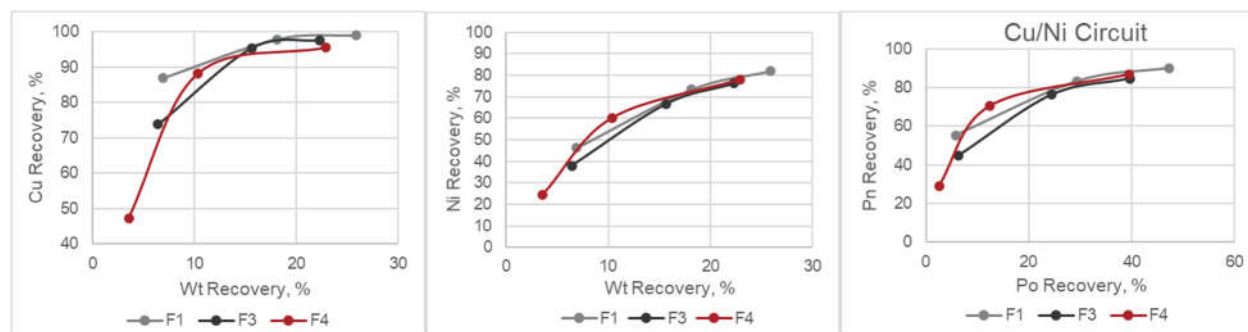

Figure 13: Flotation Results of F1, F3, and F4

4.2.2. Depressants (Na_2SO_3 , DETA)

Based on test F-1, the first cleaner kinetics test was evaluated in test F-2, with both the Cu/Ni rougher concentrate and the Po rougher concentrate reground in a 2 kg rod mill, separately, followed by a Cu/Ni cleaner circuit and a Po cleaner circuit. The nickel grade in Cu/Ni 1st cleaner concentrate was low at ~6% Ni, due to high pyrrhotite content. Selective depression of pyrrhotite was understood to be very critical to achieve concentrate grade target based on these initial results.

The evaluation of pyrrhotite depressants sodium sulphite (Na_2SO_3) and diethylenetriamine (DETA) was performed in tests F-5 to F-12, and F-23. Various dosages of Na_2SO_3 and DETA were evaluated, to minimize the nickel loss, while maximizing pyrrhotite rejection. Most of the tests were based on test F-2,

with the primary grind at F_{80} of $\sim 100 \mu\text{m}$, except F-11 at F_{80} of $\sim 150 \mu\text{m}$. Key testing conditions and results are summarized in Table 14 and Table 15, respectively.

The main conclusions are summarized below:

- No depressing effect with Na_2SO_3 alone. See Figure 14. Test F-9 with 500 g/t Na_2SO_3 alone showed no depressing effect, even a detrimental effect, compared to the baseline test F-2, conducted with no depressants.
- DETA improved the selectivity of pentlandite against pyrrhotite, but its dosage is critical. See Figure 15. With too high a dosage of DETA (≥ 75 g/t, tests F-5, F-7), pentlandite floated slowly and was overly depressed. When DETA dosage was 10 g/t or less (test F-10), the pyrrhotite depression was no longer effective. DETA dosages at 25-50 g/t (tests F-8, F-9) seemed to be reasonable. The 25 g/t DETA was chosen as the appropriate dosage for subsequent tests due in part to environmental concerns with overdosing DETA.
- Overdosing the collector PAX may deteriorate the depression of pyrrhotite. In test F-12, the 25 g/t DETA wasn't able to depress pyrrhotite, likely due to too much collector being added in the Cu/Ni cleaner circuit. 'Starving' dosage of PAX is important for maintaining the pyrrhotite depression.

The regrind size of the Cu/Ni 1st cleaner feed was targeted at a P_{80} of $\sim 35 \mu\text{m}$, while the Po 1st cleaner feed was targeted at a P_{80} of $\sim 20\text{-}30 \mu\text{m}$, based on the mineralogy analysis. Initially a 2 kg rod mill was used for both regrinds, however, the rod mill was not efficient for finer regrinding with excessive times to regrind the Po Rougher Concentrate to the target size (48 minutes). For later tests, an attrition mill was applied to the Po circuit regrind.

During the flotation testing program, it was noticed that the mass pull of Cu/Ni rougher concentrate would vary significantly, ranging from ~ 15 to 25% wt at the same testing conditions and applying similar pull rates. It was suspected that the ore was extremely sensitive to slight variations in the oxidizing – reducing environment due to the very high sulphide content, such as changes in the dissolved oxygen content in the water, grinding media conditions, and the duration from the time it was freshly ground to flotation. Additional measures and controls might be helpful for future testing programs.

Table 14: Summary of Test Conditions of F-2, F-5 to F-12, and F-23

Test ID	Cu/Ni Cleaners				Po Cleaners					Special Notes
	P ₈₀ (µm)	PAX g/t	Na ₂ SO ₃ g/t	DETA g/t	P ₈₀ (µm)	Regrind Mill	PAX g/t	Na ₂ SO ₃ g/t	DETA g/t	
F-2	34	3	0	0	33	RM	5	0	0	Add 50 g/t CuSO ₄ to Po Ro
F-5	35	4	500	150	31	RM	3	500	150	
F-6	49	4	500	0	41	RM	3	500	0	
F-7	32	4	250	75	37	RM	3	250	75	
F-8	35	4	100	50	26	RM	3	100	50	
F-9	31	6	100	25	18	RM	3	100	25	
F-10	31	6	100	10	28	AM	3	100	10	
F-11	30	7	100	10	17	AM	3	100	50	Primary grind at F ₈₀ of ~150 µm
F-12	45*	9	0	25	30*	RM	44	0	25	
F-23	41*	5	0	0	41*	AM	13	0	0	

* S/A on Cl Tails

RM represents Rod Mill, AM represents Attrition Mill

Table 15: Results Summary of Flotation Tests F-2, F-5 to F-12, and F-23

Test ID	Product	Wt %	Assays, %						Distribution, %					
			Cu	Ni	S	Cp	Pn	Po	Cu	Ni	S	Cp	Pn	Po
F-2	Cu/Ni 1st Cl Conc 1-3	13.4	7.32	6.10	35.7	21.2	16.1	59.5	95.9	69.5	29.1	95.9	79.9	21.2
	Cu/Ni Ro Conc 1-3	19.9	4.99	4.50	34.0	14.5	11.6	65.2	97.4	76.4	41.4	97.4	85.6	34.6
	Po 1st Cl Conc 1-4	25.4	0.09	0.93	35.1	0.26	1.33	89.8	2.2	20.1	54.4	2.2	12.5	60.7
	Po Ro Conc 1-3	28.3	0.09	0.88	32.8	0.25	1.25	84.0	2.4	21.1	56.8	2.4	13.2	63.4
	Po Ro Tails	51.7	0.01	0.06	0.59	0.01	0.07	1.46	0.3	2.5	1.9	0.3	1.3	2.0
F-5	Cu/Ni 1st Cl Conc 1-3	4.8	19.8	9.10	34.0	57.3	25.1	14.9	91.6	37.5	10.0	91.6	45.0	1.9
	Cu/Ni Ro Conc 1-3	17.7	5.62	4.85	33.7	16.3	12.6	62.0	95.7	73.4	36.3	95.7	83.2	29.1
	Po 1st Cl Conc 1-3	1.8	0.95	2.70	34.4	2.75	6.35	81.4	1.7	4.2	3.8	1.7	4.3	3.9
	Po Ro Conc 1-3	17.8	0.18	1.06	32.3	0.52	1.78	82.0	3.1	16.1	35.0	3.1	11.8	38.8
	Po Ro Tails	64.5	0.02	0.19	7.31	0.06	0.21	18.8	1.2	10.5	28.7	1.2	5.0	32.1
F-6	Cu/Ni 1st Cl Conc 1-4	18.3	5.26	4.66	35.5	15.3	12.0	68.0	94.4	74.8	39.4	94.4	84.5	32.8
	Cu/Ni Ro Conc 1-3	29.0	3.37	3.26	34.2	9.78	8.04	72.9	95.9	83.1	60.1	95.9	89.8	55.8
	Po 1st Cl Conc 1-3	5.9	0.34	1.25	33.8	0.98	2.28	85.1	1.9	6.4	12.0	1.9	5.1	13.1
	Po Ro Conc 1-3	14.9	0.21	0.88	30.5	0.61	1.35	77.4	3.1	11.5	27.6	3.1	7.8	30.5
	Po Ro Tails	64.5	0.02	0.19	7.31	0.06	0.21	18.8	1.2	10.5	28.7	1.2	5.0	32.1
F-7	Cu/Ni 1st Cl Conc 1-3	5.7	16.6	11.2	34.2	48.2	30.7	18.7	94.4	57.3	12.1	94.4	69.2	2.9
	Cu/Ni Ro Conc 1-3	20.0	4.89	4.28	34.5	14.2	10.9	67.3	96.8	76.5	42.6	96.8	85.9	36.2
	Po 1st Cl Conc 1-3	2.5	0.55	2.56	35.2	1.60	5.94	85.0	1.3	5.6	5.4	1.3	5.7	5.6
	Po Ro Conc 1-3	19.0	0.13	0.90	32.6	0.36	1.33	83.2	2.4	15.3	38.3	2.4	9.9	42.5
	Po Ro Tails	61.0	0.01	0.15	5.06	0.04	0.17	13.0	0.8	8.2	19.1	0.8	4.2	21.2
F-8	Cu/Ni 1st Cl Conc 1-3	7.8	12.5	9.54	34.7	36.3	26.0	34.8	95.2	63.4	15.9	95.2	75.9	6.9
	Cu/Ni Ro Conc 1-3	22.0	4.46	4.08	34.8	12.9	10.4	69.8	96.5	77.1	45.4	96.5	85.9	39.5
	Po 1st Cl Conc 1-3	2.7	0.57	2.61	35.7	1.65	6.06	86.1	1.5	6.1	5.7	1.5	6.2	6.0
	Po Ro Conc 1-3	16.9	0.16	1.00	33.4	0.46	1.58	85.1	2.6	14.5	33.5	2.6	10.1	37.0
	Po Ro Tails	61.0	0.02	0.16	5.86	0.04	0.17	15.0	0.9	8.4	21.1	0.9	4.0	23.5

Continued on next page ...

Table 15: Results Summary of Flotation Tests F-2, F-5 to F-12, and F-23 (Cont'd)

Test ID	Product	Wt %	Assays, %						Distribution, %					
			Cu	Ni	S	Cp	Pn	Po	Cu	Ni	S	Cp	Pn	Po
F-9	Cu/Ni 1st CI Conc 1-4	7.3	13.1	9.87	34.5	38.0	27.0	32.0	94.2	61.0	15.3	94.2	72.4	6.2
	Cu/Ni Ro Conc 1-3	18.0	5.43	4.83	34.3	15.7	12.5	64.1	96.6	73.8	37.8	96.6	83.2	30.8
	Po 1st CI Conc 1-3	5.2	0.34	1.89	35.0	0.99	4.05	86.7	1.8	8.4	11.2	1.8	7.8	12.1
	Po Ro Conc 1-3	18.5	0.17	1.05	32.5	0.49	1.76	82.5	3.1	16.5	36.7	3.1	12.0	40.6
	Po Ro Tails	63.5	0.01	0.18	6.59	0.01	0.21	16.9	0.3	9.7	25.5	0.3	4.8	28.6
F-10	Cu/Ni 1st CI Conc 1-4	11.4	8.36	6.71	35.2	24.2	17.9	53.9	94.8	66.8	24.9	94.8	77.6	16.7
	Cu/Ni Ro Conc 1-3	18.4	5.29	4.63	33.9	15.3	12.0	63.9	96.6	74.3	38.8	96.6	83.7	31.8
	Po 1st CI Conc 1-3	5.0	0.34	1.86	33.9	0.97	4.00	83.7	1.7	8.2	10.6	1.7	7.7	11.4
	Po Ro Conc 1-3	18.8	0.14	1.03	31.9	0.40	1.73	81.1	2.6	16.9	37.2	2.6	12.4	41.2
	Po Ro Tails	62.8	0.01	0.16	6.16	0.04	0.16	15.8	0.8	8.8	24.0	0.8	3.9	26.9
F-11	Cu/Ni 3rd CI Conc	3.8	22.1	9.51	33.4	64.1	26.3	5.9	84.2	32.1	7.9	84.2	38.9	0.6
	Cu/Ni 2nd CI Conc	4.2	20.5	9.82	33.5	59.5	27.1	9.7	86.6	36.7	8.8	86.6	44.4	1.1
	Cu/Ni 1st CI Conc	5.2	17.2	9.44	33.7	49.9	25.9	20.0	89.0	43.2	10.8	89.0	51.9	2.8
	Cu/Ni Ro Conc 1-3	14.0	6.98	5.19	33.3	20.2	13.6	56.4	97.4	64.1	28.8	97.4	73.6	21.3
	Po 1st CI Conc 1-3	3.0	0.32	2.23	33.5	0.92	5.05	81.8	1.0	6.0	6.3	1.0	5.9	6.7
	Po Ro Conc 1-3	13.7	0.16	1.45	33.3	0.48	2.87	83.5	2.2	17.5	28.0	2.2	15.1	30.6
	Po Ro Tails	72.3	0.01	0.29	9.68	0.01	0.41	24.8	0.4	18.5	43.2	0.4	11.4	48.1
F-12	Cu/Ni 1st CI Conc 1-4	14.8	6.61	5.82	36.0	19.1	15.3	62.9	94.8	74.0	32.4	94.8	84.8	24.7
	Cu/Ni Ro Conc 1-3	24.9	3.98	3.78	34.6	11.5	9.50	71.2	95.8	80.6	52.2	95.8	88.3	46.9
	Po 3rd CI Conc	1.1	0.84	3.14	37.0	2.43	7.51	87.5	0.9	3.0	2.5	0.9	3.1	2.6
	Po Ro Conc 1-3	15.8	0.18	0.91	30.9	0.52	1.41	78.7	2.8	12.3	29.8	2.8	8.4	33.0
	Po Ro Tails	59.3	0.03	0.14	5.00	0.07	0.15	12.8	1.4	7.1	18.0	1.4	3.3	20.1
F-23	Cu/Ni 2nd CI Conc 1	5.3	16.1	9.34	35.4	46.7	25.6	27.6	83.3	41.6	11.7	83.3	49.1	4.0
	Cu/Ni 1st CI Conc 1-3	7.5	11.9	8.48	35.7	34.6	23.0	41.6	86.9	53.2	16.6	86.9	62.2	8.5
	Cu/Ni Ro Conc 1-3	19.0	5.19	4.69	34.5	15.0	12.1	65.5	96.3	75.0	41.0	96.3	83.6	34.1
	Po 3rd CI Conc	0.6	0.81	3.09	36.3	2.35	7.39	85.8	0.5	1.6	1.4	0.5	1.6	1.4
	Po Ro Conc 1-3	19.3	0.13	1.03	32.3	0.38	1.71	82.1	2.5	16.7	38.9	2.5	11.9	43.4
	Po Ro Tails	61.7	0.02	0.16	5.21	0.06	0.20	13.3	1.2	8.3	20.1	1.2	4.4	22.5

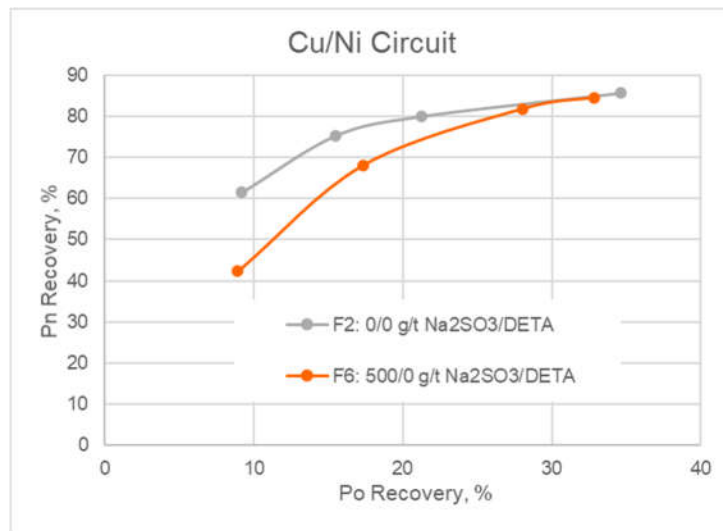

Figure 14: Effect of Na₂SO₃ Alone on Pn Selectivity Against Po

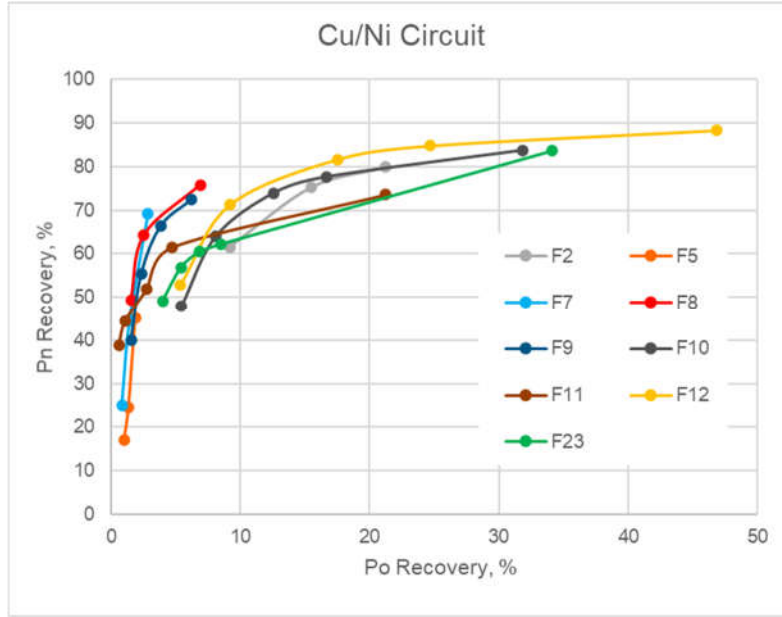

Figure 15: Effect of Na₂SO₃ and DETA Dosages on Pn Selectivity Against Po

4.2.3. Alternative Flowsheet Options

Three alternative flowsheet options were investigated in tests F-13, F-20, and F-39. Briefly the differences of these flowsheet are:

- F-13: Bulk Ro (Cu/Ni Ro + Po Ro) float, regrind, and cleaning stage, followed with Cleaner Tailings regrind and flotation
- F-20: Po Ro Conc and Cu/Ni CI Tails separate regrinds and flotation
- F-39: Regrind and flotation of Po Ro Conc + Cu/Ni CI Tails together. A Po Rougher Scavenger was included with 50 g/t CuSO₄ and 30 g/t PAX.

The three flowsheets are depicted in Figure 16. The testing conditions and results are summarized in Table 16 and Table 17, respectively.

Table 16: Summary of Testing Conditions of F-13, F-20, and F-39

Test ID	F ₈₀ (µm)	Cu/Ni Cleaners (& Scavenger)			Cu/Ni Tails Cleaners		Po Cleaners		
		Regrind P80 (µm)	PAX g/t	DETA g/t	PAX g/t	DETA g/t	Regrind P80 (µm)	PAX g/t	DETA g/t
F-13	100	33	11	25	-	-	21	55	10
F-20	150	50*	7	25	7	55	127*	10	55
F-39	100	27	7 (5)	25	-	-	25	7	0

* S/A on CI Tails

The copper and nickel recoveries in the 1st cleaner concentrates of test F-13 were high, at 98% and 81%, respectively. However, too much pyrrhotite was floated, and the copper and nickel grades in the cleaner concentrates were low. It is possible that the target grades could be achieved with reasonably good recoveries with additional cleaning stages.

Test F-20 was tested with a coarser primary grind ($F_{80} \sim 150 \mu\text{m}$). The nickel recovery in the Cu/Ni 1st Cleaner & Scavenger Concentrate was a lower at ~56% than a typical flotation test (F-9) using a 100 μm primary grind, ~61%. The nickel grade was similar, ~9.4% Ni in F-20 versus 9.9% Ni in F-9. Both the Cu/Ni Tails Recleaning and Po Cleaning recovered an additional 4-5% nickel. The nickel generated in the Cu/Ni Tails Recleaning stage was slightly higher grade than the Po cleaner circuit.

The flowsheet used in F-39 was adopted from the flowsheet developed for Selkirk Samples (reported separately). This test was performed after the locked cycle tests were completed. The results demonstrated a good potential with this flowsheet, as the Po circuit with the addition of Cu/Ni Cleaner Tails generated a nickel concentrate with reasonably good grade and recovery. The copper and nickel recoveries in the Cu/Ni cleaner circuit was low, at 88% and 50%, respectively. The reasons for this could be the low mass pull of Cu/Ni rougher stage, collector under-dosage, or insufficient residence time in the Cu/Ni cleaner stage.

The addition of Po Rougher Scavenger stage in test F-39 produced a low-sulphide final tailings, at 0.44% S.

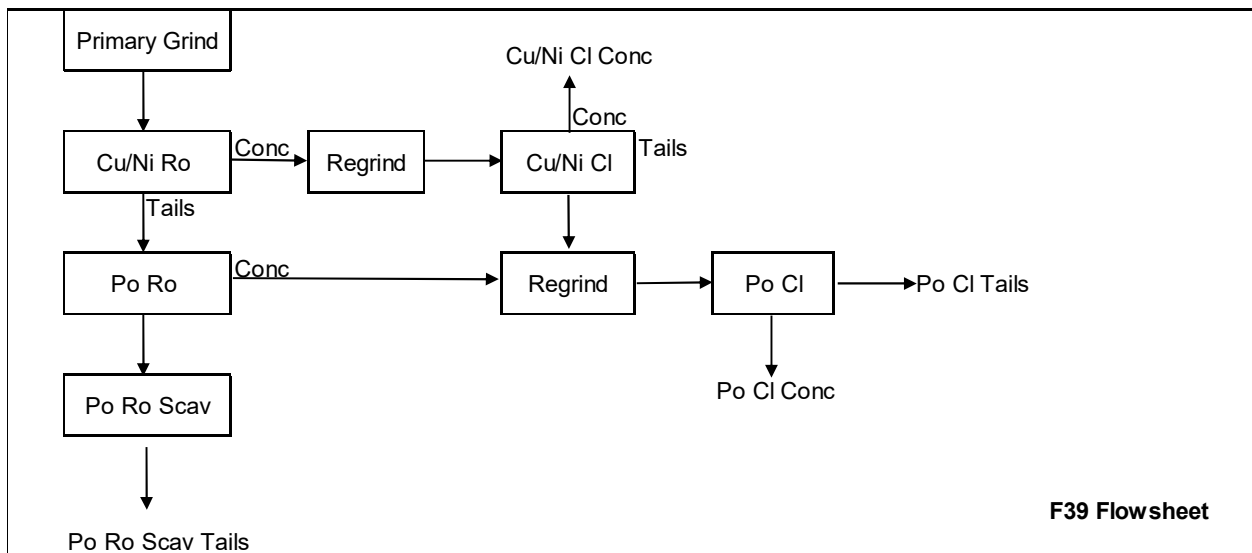
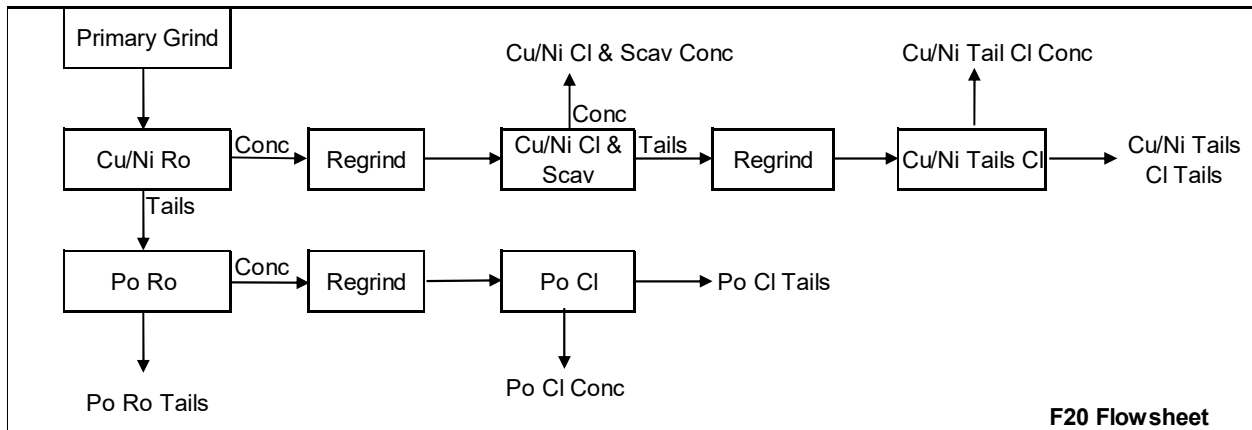
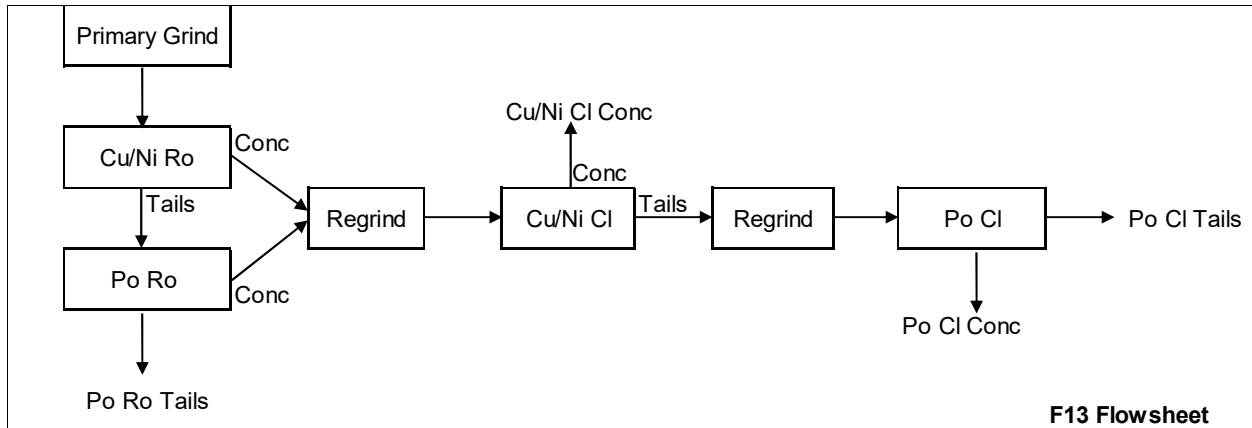

Figure 16: Flowsheet of F-13, F-20, and F-39

Table 17: Results Summary of Flotation Tests F-13, F-20, and F-39.

Test ID	Product	Wt %	Assays, %						Distribution, %					
			Cu	Ni	S	Cp	Pn	Po	Cu	Ni	S	Cp	Pn	Po
F-13	Cu/Ni 1st CI Conc 1-4	20.5	4.90	4.46	36.7	14.2	11.4	72.7	97.6	80.5	45.1	97.6	90.4	38.8
	Po 1st CI Conc 1	1.9	0.11	1.16	34.2	0.32	2.01	86.8	0.2	2.0	4.0	0.2	1.5	4.4
	Cu/Ni 1st CI Tails/Po Feed	13.8	0.05	0.69	32.0	0.15	0.77	82.4	0.7	8.5	26.6	0.7	4.1	29.8
	Cu/Ni Ro Conc 1-3&Po Ro Conc 1-2	34.3	2.94	2.94	34.8	8.53	7.10	76.6	98.3	89.0	71.8	98.3	94.5	68.6
	Po Ro Tails	65.7	0.03	0.19	7.16	0.08	0.21	18.3	1.7	11.0	28.2	1.7	5.5	31.4
F-20	Cu/Ni 1st CI Conc	6.1	15.0	9.58	35.4	43.5	26.2	30.0	90.0	50.3	12.7	90.0	60.6	4.6
	Cu/Ni 1st CI & Scav Conc	6.9	13.5	9.41	35.5	39.1	25.7	34.6	92.6	56.5	14.5	92.6	67.8	6.1
	Cu/Ni Tails 2nd CI Conc	1.0	1.42	5.01	37.8	4.12	12.8	83.5	1.4	4.4	2.3	1.4	5.0	2.2
	Cu/Ni 1st CI Tails	12.9	0.29	1.32	35.1	0.83	2.43	88.4	3.7	14.7	26.7	3.7	11.9	29.1
	Cu/Ni Ro Conc 1-3	19.8	4.91	4.15	35.3	14.2	10.6	69.6	96.2	71.2	41.2	96.2	79.8	35.2
	Po 2nd CI Conc	3.0	0.32	1.84	38.5	0.93	3.78	95.9	0.9	4.8	6.8	0.9	4.3	7.3
	Po Ro Conc 1-3	11.8	0.19	1.30	35.9	0.56	2.36	90.7	2.3	13.3	24.9	2.3	10.6	27.3
Po Ro Tails	68.4	0.02	0.26	8.39	0.06	0.37	21.4	1.5	15.4	33.9	1.5	9.6	37.5	
F-39	Cu/Ni 1st CI & Scav Conc	5.6	15.2	10.5	33.8	44.1	28.9	23.0	87.6	50.3	11.8	87.6	60.0	3.5
	Po 3rd CI Conc	1.1	1.84	7.64	36.8	5.33	20.2	73.4	2.1	7.2	2.5	2.1	8.2	2.2
	Cu/Ni 1st CI Tails & Po Ro Conc 1-3	38.5	0.29	1.38	33.7	0.83	2.65	84.5	11.3	45.4	80.7	11.3	37.8	88.2
	Cu/Ni Ro Conc 1-3 & Po Ro Conc	44.1	2.18	2.54	33.7	6.32	5.98	76.7	98.9	95.7	92.4	98.9	97.9	91.7
	F39 Po Ro Scav Tails	52.8	0.01	0.05	0.44	0.04	0.06	1.05	0.8	2.4	1.4	0.8	1.2	1.5

4.2.4. Cu-Ni Separation

Two flotation tests (F-16 and F-19) were performed to evaluate the copper and nickel separation efficiency, by depressing nickel at high pH (>11.5). The summary of Cu-Ni separation testing conditions and flotation test results are shown in Table 18 and Table 19, respectively.

Based on F-9, test F-16 included an aeration stage for 10 minutes prior to the flotation. Lime was added to target pH 11.5. The copper - nickel separation was poor, with too much pentlandite lost to the copper concentrate. About 9% of the available pentlandite was lost to the Cu 3rd Cleaner Concentrate at a grade of 2% Ni.

In test F-19, a polish grind using a pebble mill and a high lime dosage (500 g/t) was applied. The nickel was well-depressed, producing a copper concentrate with <1% Ni (0.4% to be exact) with <1% pentlandite distributed to the final copper concentrate. The copper final recovery was low (54%), but may be improved with additional collector. The nickel grade of nickel concentrate (Cu Rougher Scavenger Tails) was on-spec, >10% Ni.

Table 18: Summary of Testing Conditions for F-16 and F-19

Test ID	Cu - Ni Separation				
	Polish Grind	Aeration/ Cond, min	Lime in Grind/Initial Float g/t	PAX g/t	pH
F-16	No	10	165	1	11.5
F-19	Yes	0	500	1	11.5

Table 19: Results Summary of Tests F-16 and F-19

Test ID	Product	Wt %	Assays, %						Overall Distribution, %						Stage Recovery, %		
			Cu	Ni	S	Cp	Pn	Po	Cu	Ni	S	Cp	Pn	Po	Cp	Pn	Po
F-16	Cu 3rd Cl Conc	2.4	28.8	2.13	35.1	83.5	5.8	10.3	68.8	4.4	5.3	68.8	5.2	0.7	76.9	8.7	44.2
	Cu 2nd Cl Conc	2.9	26.2	4.09	34.8	76.0	11.2	11.6	75.2	10.2	6.3	75.2	12.2	0.9	84.1	19.9	52.6
	Cu 1st Cl Conc	3.6	23.0	6.77	34.5	66.5	18.6	13.0	81.8	21.0	7.7	81.8	25.2	1.3	91.5	41.0	64.8
	Cu Ro Conc	4.4	19.3	9.47	34.3	56.1	26.1	15.6	84.8	36.2	9.5	84.8	43.3	1.9	94.8	70.6	79.2
	Cu Ro & Scav Conc	5.1	17.7	10.4	34.3	51.2	28.7	18.0	88.9	45.7	10.9	88.9	54.7	2.5	99.4	89.2	91.1
	Cu Ro Scav Tails	0.5	1.01	12.4	32.9	2.93	33.7	53.9	0.5	5.5	1.1	0.5	6.5	0.8			
	Cu/Ni 2nd Cl Conc	5.6	16.1	10.61	34.2	46.8	29.2	21.3	89.4	51.3	12.0	89.4	61.3	3.3			
F-19	Cu 3rd Cl Conc	1.6	33.8	0.42	35.1	98.0	1.15	1.12	54.2	0.6	3.4	54.2	0.7	0.0	58.4	0.9	20.2
	Cu 2nd Cl Conc	1.9	32.8	0.68	34.7	95.2	1.86	2.11	61.7	1.1	3.9	61.7	1.3	0.1	66.5	1.8	23.4
	Cu 1st Cl Conc	2.2	30.8	1.34	34.2	89.2	3.67	4.58	65.8	2.4	4.4	65.8	2.9	0.3	70.9	4.0	26.3
	Cu Ro Conc	2.6	27.1	3.37	33.9	78.6	9.25	8.67	70.9	7.5	5.4	70.9	8.9	0.6	76.4	12.3	31.8
	Cu Ro & Scav Conc	3.5	23.8	5.46	34.0	69.0	15.0	12.7	83.0	16.2	7.2	83.0	19.3	1.2	89.5	26.4	42.6
	Cu Ro Scav Tails	4.6	2.12	11.5	34.7	6.14	31.1	57.9	9.8	44.9	9.7	9.8	53.0	7.0			
	Cu/Ni 1st Cl Conc	8.2	11.5	8.90	34.4	33.2	24.2	38.4	92.8	61.1	16.8	92.8	72.3	8.2			

4.3. Flowsheet Evaluation with P and S Comp

Three flotation tests were performed on the S Comp and four tests on the P Comp, to evaluate the response to the flowsheet developed for the SN Comp (F-9, F-19). A summary of testing conditions is presented in Table 20 and results are presented in Table 21 and Table 22.

Below summarized the key findings from these tests:

S Comp:

- The rougher kinetics test (F-14) was similar to that of SN Comp, with a bit higher nickel recovery (84%). The coarse primary grind at a F_{80} of 150 μm was appropriate for the S Comp.
- Test F-17 evaluated the flowsheet similar to test F-9. The nickel recovery in the Cu/Ni 1st Cleaner Concentrate was good, at 71%, with a grade of 5.4% Ni.
- The Cu-Ni separation was successfully demonstrated in test F-21. A high-grade copper concentrate (33% Cu) with low nickel content (0.2% Ni) was produced. An on-spec nickel concentrate was produced as well, at 12.5% Ni. The copper recovery was lower than expected, but might be improved with slightly more collector.

P Comp:

- The rougher kinetics test (F-15) was similar to that of SN Comp, with a bit lower nickel recovery (67%).
- The nickel recovery of the Cu/Ni 1st Cleaner Concentrate in the standard flowsheet evaluation (test F-18) was slightly low, at 57%.
- The Cu-Ni separation was successfully demonstrated in test F-22. Both the copper concentrate and nickel concentrate were on-spec. The nickel recovery was low, and could benefit from slightly higher collector dosages in the Cu/Ni cleaner circuit.
- The nickel recovery in the Po circuit could be further improved, as shown in test F-37 with the alternative flowsheet (similar to F-39), ~8% nickel recovery at a grade of 3.4% Ni.

Table 20: Summary of Testing Conditions of F-14, F-15, F-17, F-18, F-21, F-22, and F-37.

Test ID	Sample ID	F ₈₀ (µm)	Cu/Ni Ro	Po Ro	Cu/Ni Cl (& Scav)			Cu/Ni Tails ReCl	Po Cleaners			Cu - Ni Separation			
			PAX g/t	PAX g/t	P ₈₀ (µm)	PAX g/t	DETA g/t	PAX g/t	P ₈₀ (µm)	PAX g/t	DETA g/t	Polish Grind, min	Lime in Grind g/t	PAX g/t	pH
F-14	S Comp	142	15	30	-	-	-	-	-	-	-	-	-	1	11.5
F-17	S Comp	158	17.5	30	51*	6	25	-	50*	5	30	-	-	1	11.5
F-21	S Comp	158	17.5	30	-	7	25	12	-	10	30	7	900	2	11.6
F-15	P Comp	147	15	60	-	-	-	-	-	-	-	-	-	-	-
F-18	P Comp	98	15	30	41*	6	25	-	42*	5	30	-	-	-	-
F-22	P Comp	147	15	30	38*	8	25	13	40*	6	25	10	350	1	11.7
F-37	P Comp	98	20	60	26	7 (7)	25	-	36	4	0	-	-	-	-

* S/A on Cl Tails

Table 21: Results Summary of Tests F-14, F-17, and F-21 (S Comp)

Test ID	Product	Wt %	Assays, %						Distribution, %					
			Cu	Ni	S	Cp	Pn	Po	Cu	Ni	S	Cp	Pn	Po
F-14	Cu/Ni Ro Conc 1-3	22.7	8.18	3.29	33.6	23.7	8.33	58.6	97.8	83.6	63.7	97.8	90.1	54.7
	Po Ro Conc 1-3	9.5	0.35	0.97	32.8	1.00	1.52	83.0	1.7	10.3	26.1	1.7	6.9	32.6
	Po Ro Tails	67.8	0.01	0.08	1.80	0.04	0.09	4.6	0.5	6.1	10.2	0.5	3.0	12.7
F-17	Cu/Ni 1st Cl Conc 1-3	11.9	15.9	5.38	35.3	46.2	14.4	37.2	96.5	70.5	35.6	96.5	80.0	18.8
	Cu/Ni 1st Cl Conc 1-4	15.3	12.5	4.53	35.9	36.1	11.9	50.1	97.2	76.4	46.6	97.2	84.9	32.5
	Cu/Ni Ro Conc 1-3	23.5	8.19	3.26	33.6	23.7	8.23	58.7	97.9	84.2	66.9	97.9	90.0	58.4
	Po 1st Cl Conc 1-3	4.2	0.35	1.24	36.8	1.01	2.16	92.9	0.7	5.7	13.1	0.7	4.2	16.5
	Po Ro Conc 1-3	8.9	0.27	0.99	32.5	0.78	1.59	82.2	1.2	9.7	24.6	1.2	6.6	31.1
	Po Ro Tails	67.6	0.03	0.08	1.48	0.08	0.11	3.68	0.9	6.1	8.5	0.9	3.4	10.6
F-21	Cu 3rd Cl Conc	3.2	33.0	0.22	35.0	95.7	0.56	3.47	55.5	0.8	9.7	55.5	0.9	0.5
	Cu Ro Scav Tails	3.8	7.48	12.5	34.1	21.7	34.2	39.6	14.8	53.5	11.1	14.8	62.2	6.4
	Cu/Ni 2nd Cl Conc	9.4	19.3	5.86	34.4	56.0	15.9	24.9	95.4	62.6	27.9	95.4	72.4	10.0
	Cu/Ni Ro Conc 1-3	25.0	7.49	3.05	33.0	21.7	7.64	59.5	98.2	86.4	71.0	98.2	92.0	63.6
	Cu/Ni Tails 1st Cl Conc	4.8	0.19	1.10	37.7	0.55	1.72	95.9	0.5	5.9	15.5	0.5	4.0	19.6
	Po 3rd Cl Conc	0.5	0.23	1.51	38.8	0.67	2.84	97.7	0.1	0.9	1.8	0.1	0.7	2.3
	Po Ro Conc 1-3	7.0	0.24	0.93	32.0	0.70	1.45	81.3	0.9	7.4	19.4	0.9	4.9	24.5
	Po Ro Tails	67.9	0.03	0.08	1.65	0.08	0.10	4.13	1.0	6.2	9.6	1.0	3.1	12.0
Head (Dir.)		1.90	0.88	11.9	5.51	2.06	24.1							

Table 22: Results Summary of Tests F-15, F-18, F-22, and F-37 (P Comp)

Test ID	Product	Wt %	Assays, %						Distribution, %					
			Cu	Ni	S	Cp	Pn	Po	Cu	Ni	S	Cp	Pn	Po
F-15	Cu/Ni Ro Conc 1-3	12.5	3.12	4.19	32.3	9.05	10.7	66.4	94.9	66.7	37.8	94.9	75.2	33.0
	Po Ro Conc 1-3	13.5	0.08	1.07	32.4	0.24	1.80	82.4	2.7	18.2	40.8	2.7	13.6	44.1
	Po Ro Tails	74.0	0.01	0.16	3.09	0.04	0.27	7.76	2.3	15.1	21.4	2.3	11.2	22.9
F-18	Cu/Ni 1st Cl Conc 1-4	4.6	7.74	9.71	36.5	22.4	26.2	52.0	86.3	56.5	16.3	86.3	66.8	9.9
	Cu/Ni Ro Conc 1-3	12.0	3.18	4.56	33.3	9.21	11.7	68.1	91.6	68.6	38.4	91.6	77.1	33.6
	Po 1st Cl Conc 1-3	3.7	0.39	1.93	35.6	1.13	4.13	87.9	3.5	8.9	12.6	3.5	8.4	13.3
	Po Ro Conc 1-3	12.6	0.15	1.08	31.8	0.44	1.87	80.7	4.6	17.1	38.8	4.6	13.0	42.0
	Po Ro Tails	75.4	0.02	0.15	3.14	0.06	0.24	7.89	3.8	14.2	22.8	3.8	10.0	24.5
F-22	Cu 2nd Cl Conc	0.3	32.2	0.17	33.7	93.3	0.44	2.31	21.5	0.1	0.9	21.5	0.1	0.03
	Cu Ro Scav Tails	1.7	3.18	16.3	39.2	9.22	44.5	55.3	12.5	35.2	6.0	12.5	42.6	3.6
	Cu/Ni 2nd Cl Conc	2.7	12.6	11.0	37.1	36.6	30.1	37.3	81.7	39.2	9.4	81.7	47.5	4.0
	Cu/Ni Ro Conc 1-3	11.7	3.33	4.19	31.9	9.64	10.7	65.0	92.0	63.6	34.7	92.0	72.3	30.0
	Cu/Ni Tails 1st Cl Conc	1.2	0.69	3.36	42.2	2.00	7.94	101	2.0	5.4	4.8	2.0	5.6	4.9
	Po 3rd Cl Conc	0.6	0.73	4.01	43.8	2.12	9.71	104	1.0	3.1	2.5	1.0	3.4	2.5
	Po Ro Conc 1-3	12.5	0.13	1.15	30.7	0.37	2.11	77.5	3.7	18.7	35.6	3.7	15.2	38.2
	Po Ro Tails	75.7	0.02	0.18	4.25	0.07	0.29	10.7	4.3	17.6	29.8	4.3	12.5	31.9
F-37	Cu/Ni 1st Cl Conc 1-2	2.7	12.2	11.8	36.6	35.5	32.4	35.1	80.3	41.7	9.7	80.3	50.3	3.9
	Cu/Ni 1st Cl & Scav Conc	3.6	9.63	11.1	37.5	27.9	30.1	46.2	85.1	52.6	13.3	85.1	63.0	7.0
	Po 2nd Cl Conc	1.9	0.93	3.38	45.9	2.70	7.88	110	4.3	8.4	8.5	4.3	8.6	8.7
	Cu/Ni 1st Cl Tails & Po Ro Conc 1-3	24.5	0.19	1.15	32.6	0.55	2.04	82.5	11.4	37.2	79.0	11.4	29.0	85.1
	Po Ro Scav Tails	69.7	0.02	0.08	0.21	0.05	0.15	0.37	3.1	7.6	1.4	3.1	6.2	1.1
	Head (Dir.)		0.42	0.79	10.4	1.22	1.80	24.4						

4.4. Locked Cycle Testing

A total of three locked cycle tests (LCT) were completed. Two locked cycle tests (LCT-1, LCT-2) with six cycles each were completed on 2 kg test charges of the SN Comp sample included the Cu/Ni Roughers, Po Roughers, Cu/Ni Cleaners, and Po Cleaners stages. The flowsheet for both LCTs was based on test F-19, with the inclusion of a Cu/Ni Scalp stage after the Scavenger. The Cu/Ni Scalp Concentrate was combined with Po Rougher Concentrate for regrind and cleaning. The flowsheet differences of the two LCTs are:

- LCT-1 and LCT-2 targeted a F_{80} of 150 μm and 100 μm , respectively
- LCT-1 included a 2nd Cu/Ni cleaner, with the Cu/Ni 2nd cleaner tailings recirculated back to the 1st cleaner feed in the subsequent cycle. Only one Cu/Ni cleaning stage was included in LCT-2, to maximize the nickel recovery.

The Cu/Ni Cleaner Concentrate produced in cycle A of LCT-1 / LCT-2 was filtered and the total wet weight was recorded. The sample was dried in an oven and the total dry weight recorded and subsampled for assay. The Cu/Ni Cleaner Concentrates from the subsequent cycles were each filtered, the total wet weight recorded, and then subsampled for assay. The remaining wet samples were repulped and stored in a refrigerator.

The combined pulp from the Cu/Ni cleaner concentrates produced from the same LCT was then filtered, blended, and split into equal charge weights of ~200 g dry equivalent as feed for LCT-3 testing. The

moisture content of the filter cake of Cu/Ni Cleaner Concentrate Cycle A was used to estimate the dry weights of Cu/Ni Cleaner Concentrate from Cycle B to Cycle F.

The Cu-Ni separation locked cycle test (LCT-3) with seven cycles was performed on the Cu/Ni cleaner concentrates produced from the first two LCTs, based on the conditions of test F-19. LCT-3 Cycle A to D used Cu/Ni concentrate produced from LCT-2 (cycles B-F), and Cycle E to G used Cu/Ni concentrate produced from LCT-1 (cycles B-F). Details of the feed makeup for LCT-3 each cycle are illustrated in Table 23.

Table 23: The Feed Makeup of LCT-3 Each Cycle

LCT-3 Cycle A to D		LCT-3 Cycle E to G	
Product ID	Est. Dry Weight, g	Product ID	Est. Dry Weight, g
LCT-2 Cu/Ni 1st Cl Conc - B	152	LCT-1 Cu/Ni 2nd Cl Conc - B	131
LCT-2 Cu/Ni 1st Cl Conc - C	130	LCT-1 Cu/Ni 2nd Cl Conc - C	128
LCT-2 Cu/Ni 1st Cl Conc - D	170	LCT-1 Cu/Ni 2nd Cl Conc - D	121
LCT-2 Cu/Ni 1st Cl Conc - E	176	LCT-1 Cu/Ni 2nd Cl Conc - E	127
LCT-2 Cu/Ni 1st Cl Conc - F	198	LCT-1 Cu/Ni 2nd Cl Conc - F	135
LCT-2 B-F Total	828	LCT-1 B-F Total	642
Split to 4 charges		Split to 3 charges	

The flowsheets of LCT-2 and LCT-3 are illustrated in Figure 17 and Figure 18.

Details of the LCT-1, LCT-2, and LCT-3 test conditions and test results are provided in Appendix D.

4.4.1. LCT-1 and LCT-2 Test Results

A stability check was performed for each locked cycle tests based on the metal units in the exit streams of each cycle as a percentage of the units in the feed to each cycle. The stability of both LCTs was reasonable. Slight variation was observed in the last 1-2 cycles of the tests when additional amounts of PAX were introduced to the cleaner stages to improve the metal recoveries. Following a statistical analysis, cycles B to F for LCT-1 and Cycles D to F for LCT-2, were deemed to be suitable for projected mass balance calculations, to simulate the metallurgical performance that would be achieved in a continuous operation. This is presented in Table 24 and Table 25.

In LCT-1, the projected Cu/Ni 2nd cleaner concentrate graded >20% Cu+Ni, with 94% copper recovery and 55% nickel recovery. The nickel recovery was low compared to typical batch flotation tests.

The nickel recovery to the Po 3rd cleaner concentrate was 8%, with a reasonably good grade, at 5.5% Ni. Both the grade and recovery to this stage were much higher than what was typically observed in the batch

flotation tests, likely due to the displaced nickel from the bulk circuit. The inclusion of the Cu/Ni Scalp Concentrate in the Po Cleaner circuit might contribute to this.

The combined Cu/Ni 2nd Cleaner Concentrate and the Po 3rd cleaner concentrate accounted for 96% copper and 63% nickel recoveries, grading at ~20% Cu+Ni.

In LCT-2, with only one Cu/Ni cleaner stage, the Cu+Ni grade was still reasonable at ~19% Cu+Ni, at an improved nickel recovery of 64%. The nickel recovery to the Po 3rd cleaner concentrate was 5% at a grade of 7% Ni. There may be room to recover a bit more nickel in the Po cleaner stage with a bit more collector. The nickel recovery of the combined Cu/Ni 1st Cleaner Concentrate and the Po 3rd Cleaner Concentrate was 68%.

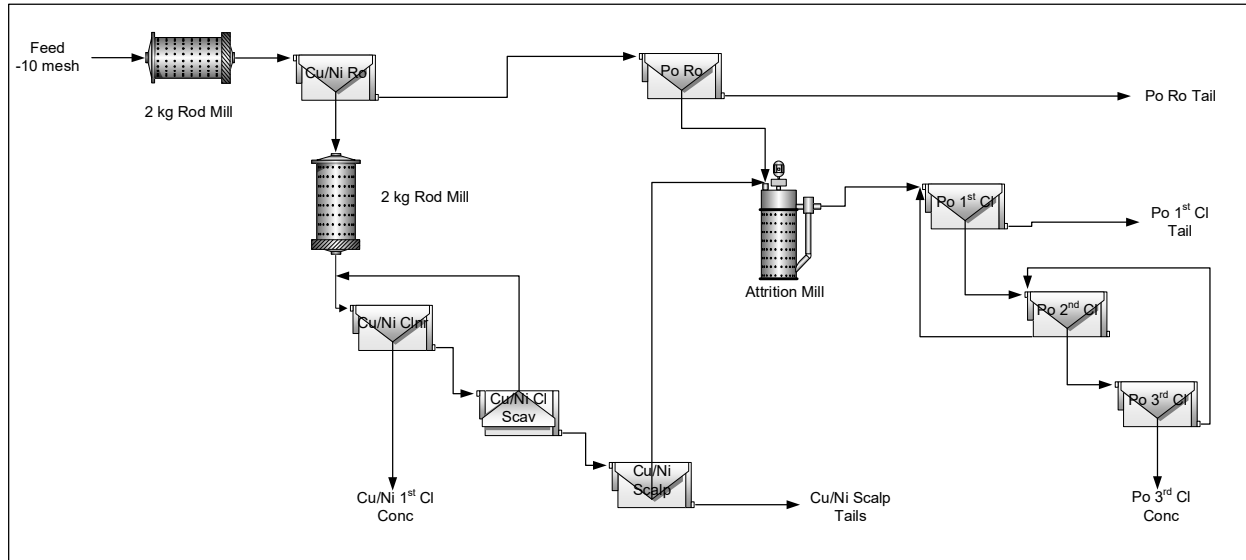

Figure 17: Flowsheet of LCT-2

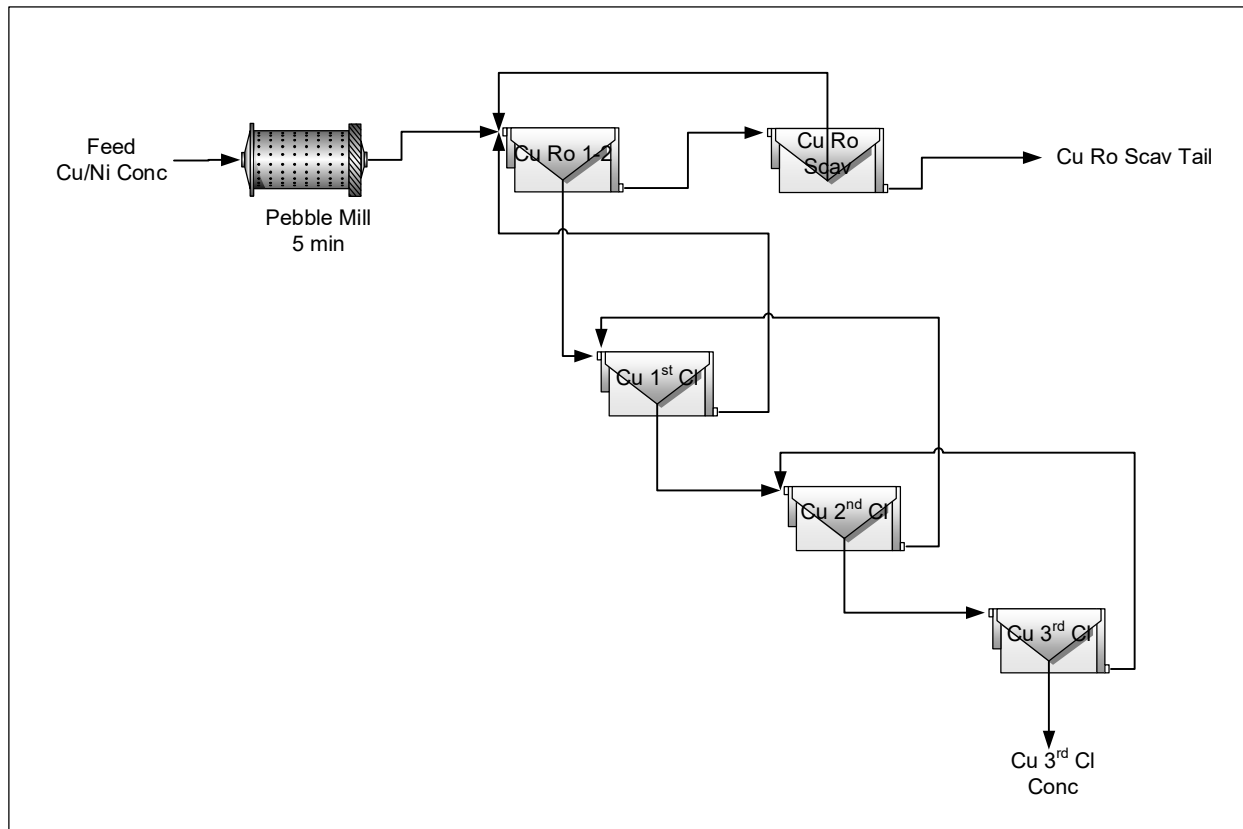

Figure 18: Flowsheet of LCT-3

Table 24: LCT-1 Metallurgical Projection (B-F)

Product	Wt %	Assays, %						% Distribution					
		Cu	Ni	S	Cp	Pn	Po	Cu	Ni	S	Cp	Pn	Po
Cu/Ni 2nd CI Conc	6.7	14.2	9.43	34.4	41.2	25.8	29.9	94.3	55.3	14.4	94.3	65.8	5.5
Cu/Ni Scalp Tail	11.7	0.16	1.07	32.8	0.47	1.80	83.3	1.9	11.0	24.2	1.9	8.1	26.8
Po 3rd CI Conc	1.7	0.78	5.54	37.1	2.27	14.2	82.1	1.3	8.1	3.9	1.3	9.1	3.8
Comb. Cu/Ni Conc	8.3	11.5	8.65	35.0	33.4	23.5	40.3	95.6	63.4	18.3	95.6	74.9	9.2
Po 1st CI Tails	22.2	0.09	1.02	33.6	0.26	1.62	85.7	2.0	19.9	47.0	2.0	13.8	52.3
Po Rougher Tail	57.8	0.01	0.11	2.90	0.03	0.14	7.37	0.6	5.8	10.5	0.6	3.2	11.7
Head (Calc.)	100	1.00	1.14	15.9	2.91	2.61	36.4	100	100	100	100	100	100
Head (Dir.)		1.07	1.17	16.5	3.10	2.69	37.7						

Table 25: LCT-2 Metallurgical Projection (D-F)

Product	Wt %	Assays, %						% Distribution					
		Cu	Ni	S	Cp	Pn	Po	Cu	Ni	S	Cp	Pn	Po
Cu/Ni 1st CI Conc	9.5	10.8	8.27	35.3	31.4	22.4	44.1	93.4	63.6	20.5	93.4	73.9	11.3
Cu/Ni Scalp Tail	7.5	0.16	0.86	33.8	0.46	1.17	86.3	1.1	5.2	15.6	1.1	3.1	17.6
Po 3rd CI Conc	0.8	1.66	7.02	36.3	4.80	18.5	74.1	1.3	4.8	1.9	1.3	5.4	1.7
Comb. Cu/Ni Conc	10.3	10.1	8.17	35.4	29.2	22.0	46.5	94.7	68.4	22.4	94.7	79.3	12.9
Po 1st CI Tails	23.7	0.18	1.12	34.5	0.51	1.89	87.5	3.8	21.6	50.2	3.8	15.6	56.1
Po Rougher Tail	58.5	0.01	0.10	3.29	0.02	0.10	8.45	0.4	4.8	11.8	0.4	2.0	13.4
Head (Calc.)	100	1.10	1.23	16.3	3.18	2.86	36.9	100	100	100	100	100	100
Head (Dir.)		1.07	1.17	16.5	3.10	2.69	37.7						

4.4.2. LCT-3 Test Results

The metallurgical balance of LCT-3 is presented in Table 26. Since the test charges for cycles A to D and cycles E to G contained different feeds (and grades), the stability check and metallurgical projection for each half of the LCT were analyzed separately. The stability analysis for cycle A through D was poor, as the locked cycle test typically requires 3-4 cycles to stabilize. Intermediate streams of Cycle D in LCT-3 were re-circulated to cycle E. Cycle D was chosen for the metallurgical projection to represent the Cu-Ni separation performance of the Cu/Ni concentrates produced from LCT-2. The projected metallurgical results are presented in Table 27.

For the test on cycle A to D, the projected metallurgical results showed the stage recovery of copper to the copper concentrate was 79% at a grade of 29% Cu, with an additional 21% stage recovered to the nickel concentrate. The nickel stage recovery to the nickel concentrate (Cu Rougher Scavenger Tails) was 93% at a grade of 11%Ni.

Following a statistical analysis, cycles F to G was deemed to be suitable for projected mass balance calculations for the test on cycle E to G. The projected metallurgical results are presented in Table 28.

For the test on cycle E to G, the projected metallurgical results showed the stage recovery of copper to the copper concentrate was 84% at a grade of 31% Cu, with an additional 16% stage recovered to the nickel concentrate. The nickel stage recovery to the nickel concentrate (Cu Rougher Scavenger Tails) was 98% at a grade of 15%Ni.

The nickel content in the Cu 3rd Cleaner Concentrate of cycle B to D was >1% Ni. However, the % Ni in the Cu 3rd Cleaner Concentrate of Cycle A was <1% Ni. A higher dosage of lime might be required in the regrind or the beginning of the copper rougher flotation to compensate for the extra mass of the re-circulated stream. Another possibility is that the PAX dosage in the copper rougher and rougher scavenger (1 g/t + 1 g/t) might be a bit too high in Cycle B to C, causing nickel losses to the copper concentrate.

Starting cycle D, the PAX dosage was reduced by half (0.5 g/t + 0.5 g/t) as well a higher dosage of lime was added to the pebble mill (750 g/t versus 625 g/t in cycle A to C). Despite this change, the nickel content in the final copper concentrate in cycle D was still >1% Ni. The recirculation streams may still contain a relatively high amount of residual PAX in cycle D. In cycle E to G, the % Ni in the Cu 3rd Cleaner Concentrate were all well below 1% Ni.

Table 26: Metallurgical Balance of LCT-3

Product	Wt %	Assays, %						% Distribution					
		Cu	Ni	S	Cp	Pn	Po	Cu	Ni	S	Cp	Pn	Po
LCT-3 Cu 3rd Cl Conc-A	2.6	32.0	0.89	34.1	92.8	2.4	2.2	6.8	0.3	2.7	6.8	0.3	0.2
LCT-3 Cu 3rd Cl Conc-B	4.5	29.8	1.86	34.1	86.4	5.1	5.7	10.7	1.0	4.5	10.7	1.0	0.7
LCT-3 Cu 3rd Cl Conc-C	5.3	28.4	2.40	34.7	82.3	6.5	9.7	12.0	1.5	5.4	12.0	1.5	1.5
LCT-3 Cu 3rd Cl Conc1-D	2.4	30.2	1.62	34.4	87.5	4.4	6.0	5.9	0.5	2.5	5.9	0.5	0.4
LCT-3 Cu 3rd Cl Conc2-D	1.8	27.0	2.32	34.3	78.3	6.3	12.6	3.9	0.5	1.8	3.9	0.5	0.7
LCT-3 Cu 3rd Cl Conc3-D	0.5	21.1	3.89	34.7	61.2	10.4	25.6	0.8	0.2	0.5	0.8	0.2	0.4
LCT-3 Cu 3rd Cl Conc-E	5.4	30.8	0.71	34.2	89.3	1.9	6.1	13.4	0.4	5.5	13.4	0.4	0.9
LCT-3 Cu 3rd Cl Conc-F	5.3	30.6	0.57	34.5	88.7	1.47	7.7	13.0	0.3	5.4	13.0	0.3	1.2
LCT-3 Cu 3rd Cl Conc-G	5.5	31.2	0.53	34.4	90.4	1.39	5.9	13.6	0.3	5.5	13.6	0.3	0.9
LCT-3 Cu 3rd Cl Tail-G	0.7	18.1	2.81	33.3	52.5	7.35	32.5	1.0	0.2	0.7	1.0	0.2	0.6
LCT-3 Cu 2nd Cl Tail-G	0.9	11.7	5.93	32.7	33.9	15.9	40.5	0.8	0.6	0.8	0.8	0.6	1.0
LCT-3 Cu 1st Cl Tail-G	1.7	7.29	10.3	33.1	21.1	28.0	42.8	1.0	2.0	1.6	1.0	2.0	2.0
LCT-3 Cu Ro Scav Conc-G	0.3	15.2	3.85	34.4	44.1	10.1	40.6	0.4	0.1	0.3	0.4	0.1	0.3
LCT-3 Cu Ro Scav Conc-D	0.6	12.9	7.33	33.6	37.4	19.9	36.3	0.7	0.5	0.6	0.7	0.5	0.7
LCT-3 Cu Ro Scav Tail-A	7.7	3.64	9.77	33.5	10.6	26.4	54.8	2.3	8.8	7.7	2.3	8.7	12.2
LCT-3 Cu Ro Scav Tail-B	8.0	3.15	10.0	33.5	9.13	27.0	55.6	2.0	9.2	7.9	2.0	9.1	12.7
LCT-3 Cu Ro Scav Tail-C	7.4	2.39	10.0	33.3	6.93	27.0	57.1	1.4	8.5	7.3	1.4	8.5	12.1
LCT-3 Cu Ro Scav Tail-D	9.9	3.21	10.5	33.3	9.30	28.4	53.7	2.5	12.0	9.7	2.5	11.9	15.2
LCT-3 Cu Ro Scav Tail-E	10.6	3.14	15.5	33.5	9.10	42.5	42.3	2.7	19.1	10.5	2.7	19.2	12.9
LCT-3 Cu Ro Scav Tail-F	9.3	3.13	15.7	33.8	9.07	43.0	42.7	2.3	16.8	9.3	2.3	16.9	11.3
LCT-3 Cu Ro Scav Tail-G	9.8	3.70	15.2	33.9	10.7	41.6	42.6	2.9	17.2	9.8	2.9	17.3	11.9
Head (Calc.) A-D	50.7	12.0	7.31	33.7	34.9	19.8	38.9	49.0	42.9	50.6	49.0	42.6	56.7
Head (Calc.) E-G	49.3	12.9	10.0	33.9	37.4	27.4	30.6	51.0	57.1	49.4	51.0	57.4	43.3
Head (Calc.) A-G	100	12.5	8.64	33.8	36.2	23.5	34.8	100	100	100	100	100	100
Head (Exp.) A-G													

Table 27: LCT-3 Metallurgical Projection-1 (D)

Product	Wt	Assays, %						% Stage Distribution					
	%	Cu	Ni	S	Cp	Pn	Po	Cu	Ni	S	Cp	Pn	Po
Cu 3rd CI Conc 1-2	30.0	28.8	1.92	34.4	83.6	5.21	8.80	79.4	7.3	30.7	79.4	7.3	6.6
Cu Ro Scav Tail	70.0	3.21	10.5	33.3	9.30	28.4	53.7	20.6	92.7	69.3	20.6	92.7	93.4
LCT-2 Cu/Ni CI Conc (Calc.)	100	10.9	7.92	33.6	31.6	21.4	40.2	100	100	100	100	100	100

Table 28: LCT-3 Metallurgical Projection-2 (F-G)

Product	Wt	Assays, %						% Stage Distribution					
	%	Cu	Ni	S	Cp	Pn	Po	Cu	Ni	S	Cp	Pn	Po
Cu 3rd CI Conc 1-2	36.1	30.9	0.55	34.4	89.6	1.43	6.82	83.6	2.0	36.5	83.6	1.9	8.3
Cu Ro Scav Tail	63.9	3.42	15.4	33.9	9.92	42.3	42.6	16.4	98.0	63.5	16.4	98.1	91.7
LCT-1 Cu/Ni CI Conc (Calc.)	100	13.3	10.1	34.1	38.7	27.5	29.7	100	100	100	100	100	100

4.4.3. LCT-1 & LCT-3 and LCT-2 & LCT-3 Combined Results

The combined results of LCT-1 & LCT-3, and LCT-2 & LCT-3 are presented in Table 29 and Table 30, respectively. The copper overall recovery of the Cu 3rd Cleaner Concentrate was 74-79% at a grade of 29-31% Cu. The nickel overall recovery of the combined Cu Rougher Scavenger Tailings and the Po 3rd Cleaner Concentrate was 62-64% at a grade of 11-12% Ni and ~3% Cu.

The nickel content in Cu concentrate could be maintained under 1% Ni by adding the proper dosage of lime to the polish mill and controlling PAX dosage to the copper rougher and scavenger stages.

Table 29: LCT-1 (B-F) & LCT-3 (F-G) Combined Metallurgical Projection

Product	Wt	Assays, %						% Distribution					
	%	Cu	Ni	S	Cp	Pn	Po	Cu	Ni	S	Cp	Pn	Po
Cu 3rd CI Conc 1-2	2.4	30.9	0.55	34.4	89.6	1.43	6.82	78.8	1.1	5.3	78.8	1.2	0.5
Cu Ro Scav Tail	4.3	3.64	14.5	34.2	10.6	39.6	42.9	15.4	54.2	9.2	15.4	64.6	5.0
Cu/Ni Scalp Tail	11.7	0.16	1.07	32.8	0.47	1.80	83.3	1.9	11.0	24.2	1.9	8.1	26.8
Po 3rd CI Conc	1.7	0.78	5.54	37.1	2.27	14.2	82.1	1.3	8.1	3.9	1.3	9.1	3.8
Po 1st CI Tails	22.2	0.09	1.02	33.6	0.26	1.62	85.7	2.0	19.9	47.0	2.0	13.8	52.3
Po Rougher Tail	57.8	0.01	0.11	2.90	0.03	0.14	7.37	0.6	5.8	10.5	0.6	3.2	11.7
Comb. Ni Conc (Cu Ro Scav Tails + Po 3rd CI Conc)	5.9	2.84	12.0	35.0	8.23	32.4	53.9	16.7	62.3	13.0	16.7	73.7	8.8
Head (Calc.)	100.0	1.00	1.14	15.9	2.91	2.61	36.4	100	100	100	100	100	100
Head (Dir.)		1.07	1.17	16.5	3.10	2.69	37.7						

Table 30: LCT-2 (D-F) & LCT-3 (D) Combined Metallurgical Projection

Product	Wt	Assays, %						% Distribution					
	%	Cu	Ni	S	Cp	Pn	Po	Cu	Ni	S	Cp	Pn	Po
Cu 3rd CI Conc 1-2	2.8	28.8	1.92	34.4	83.6	5.21	8.80	74.2	4.6	6.3	74.2	5.4	0.7
Cu Ro Scav Tail	6.6	3.19	11.0	35.0	9.24	29.6	58.8	19.2	59.0	14.2	19.2	68.5	10.5
Cu/Ni Scalp Tail	7.5	0.16	0.86	33.8	0.46	1.17	86.3	1.1	5.2	15.6	1.1	3.1	17.6
Po 3rd CI Conc	0.8	1.66	7.02	36.3	4.80	18.5	74.1	1.3	4.8	1.9	1.3	5.4	1.7
Po 1st CI Tails	23.7	0.18	1.12	34.5	0.51	1.89	87.5	3.8	21.6	50.2	3.8	15.6	56.1
Po Rougher Tail	58.5	0.01	0.10	3.29	0.02	0.10	8.45	0.4	4.8	11.8	0.4	2.0	13.4
Comb. Ni Conc (Cu Ro Scav Tails + Po 3rd CI Conc)	7.4	3.02	10.5	35.1	8.74	28.4	60.5	20.5	63.7	16.1	20.5	73.9	12.2
Head (Calc.)	100.0	1.10	1.23	16.3	3.18	2.86	36.9	100	100	100	100	100	100
Head (Dir.)		1.07	1.17	16.5	3.10	2.69	37.7						

4.5. Detailed Concentrate Assays

Concentrates from LCT-2 and LCT-3 were submitted for a typical smelter analysis suite of elements as summarized in Table 31. For each of the tests, the concentrates from the final two or three cycles (deemed to be the steady state cycles) were combined and submitted for assay. The cobalt seemed to follow the nickel, with a grade of 0.94% Co and 0.37% Co in the Cu Rougher Scavenger Tails and Po 3rd Cleaner Concentrate, respectively. The cobalt content in the Cu 3rd Cleaner Concentrate was 250 g/t Co. No obvious deleterious elements were present.

Table 31: Detailed Analysis on LCT-2, LCT-3 Products

Analyte	Unit	LCT-3 Cu 3rd CI Conc F-G	LCT-3 Cu Ro Scav Tails F-G	LCT-2 Po 3rd CI Conc D-F
Cu	%	31.2	3.4	1.68
Ni	%	0.55	15.2	7.21
S	%	34.4	33.7	35.6
Au	g/t	0.36	0.17	0.13
Pt	g/t	0.31	0.20	0.28
Pd	g/t	1.06	0.40	0.21
Rh	g/t	0.02	< 0.02	0.02
Hg	g/t	< 0.3	< 0.3	< 0.3
Ag	g/t	29	18	9
Al	g/t	240	1200	617
As	g/t	< 30	< 30	< 30
Ba	g/t	4	8	7
Be	g/t	< 0.05	< 0.05	< 0.05
Bi	g/t	< 30	< 30	< 30
Ca	g/t	1040	4910	534
Cd	g/t	21	6	4
Co	g/t	250	9390	3690
Cr	g/t	6	57	22
Fe	g/t	321000	405000	502000
K	g/t	< 200	< 200	< 200
Li	g/t	< 20	< 20	< 20
Mg	g/t	175	742	311
Mn	g/t	26	98	51
Mo	g/t	< 10	< 10	< 10
Na	g/t	32	285	186
P	g/t	< 200	< 200	< 200
Pb	g/t	61.9	66.4	75.4
Sb	g/t	35	96	56
Se	g/t	32	< 30	< 30
Sn	g/t	< 20	< 20	< 20
Sr	g/t	0.8	3.9	1.5
Ti	g/t	17	69	33
Tl	g/t	< 40	< 40	< 40
U	g/t	< 100	< 100	< 100
V	g/t	< 6	< 6	< 6
Y	g/t	< 10	< 10	< 10
Zn	g/t	390	157	151
F	%	< 0.005	< 0.005	< 0.005
Cl (HNO ₃ soluble)	g/t	16	30	24
Si	%	0.09	0.4	0.23

4.6. Process Mineralogy

F-8 Cu/Ni 1st Cleaner Tails and Po 1st Cleaner Tails (single size) were submitted for QEMSCAN analysis to better understand nickel losses. Figure 19 presents the pentlandite association summary. Figure 20 shows the image grids of the pentlandite association. The complete mineralogy report can be found in Appendix D.

The mineralogy results indicated that the main losses of pentlandite were due to poor liberation, particularly due to associations with pyrrhotite. A fine regrind, possibly a regrind on the Cu/Ni 1st Cleaner Tails might be beneficial to improved nickel recovery. This is consistent with what was observed in the flotation tests.

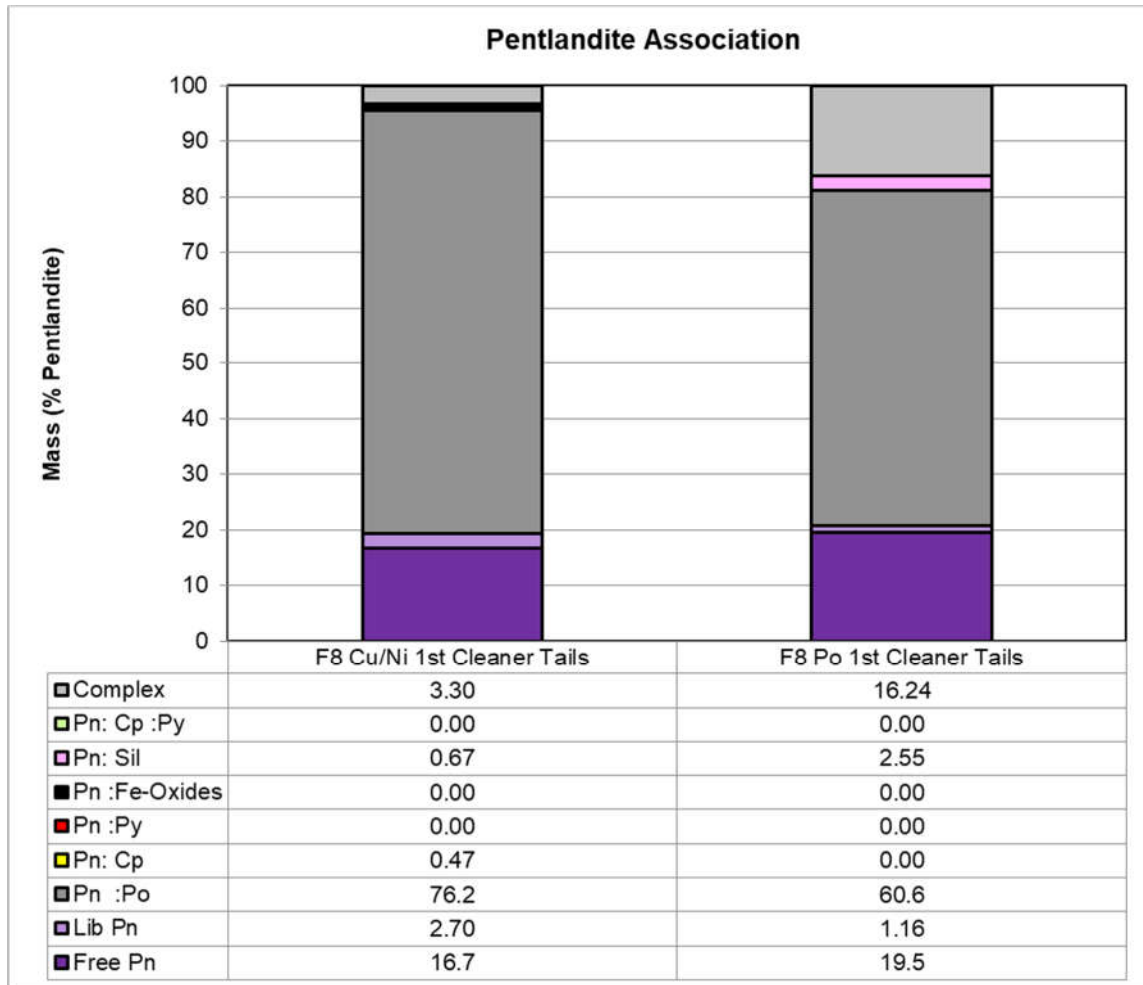

Figure 19: Pentlandite Association of Test F-8 Cu/Ni 1st Cleaner Tails and Po 1st Cleaner Tails

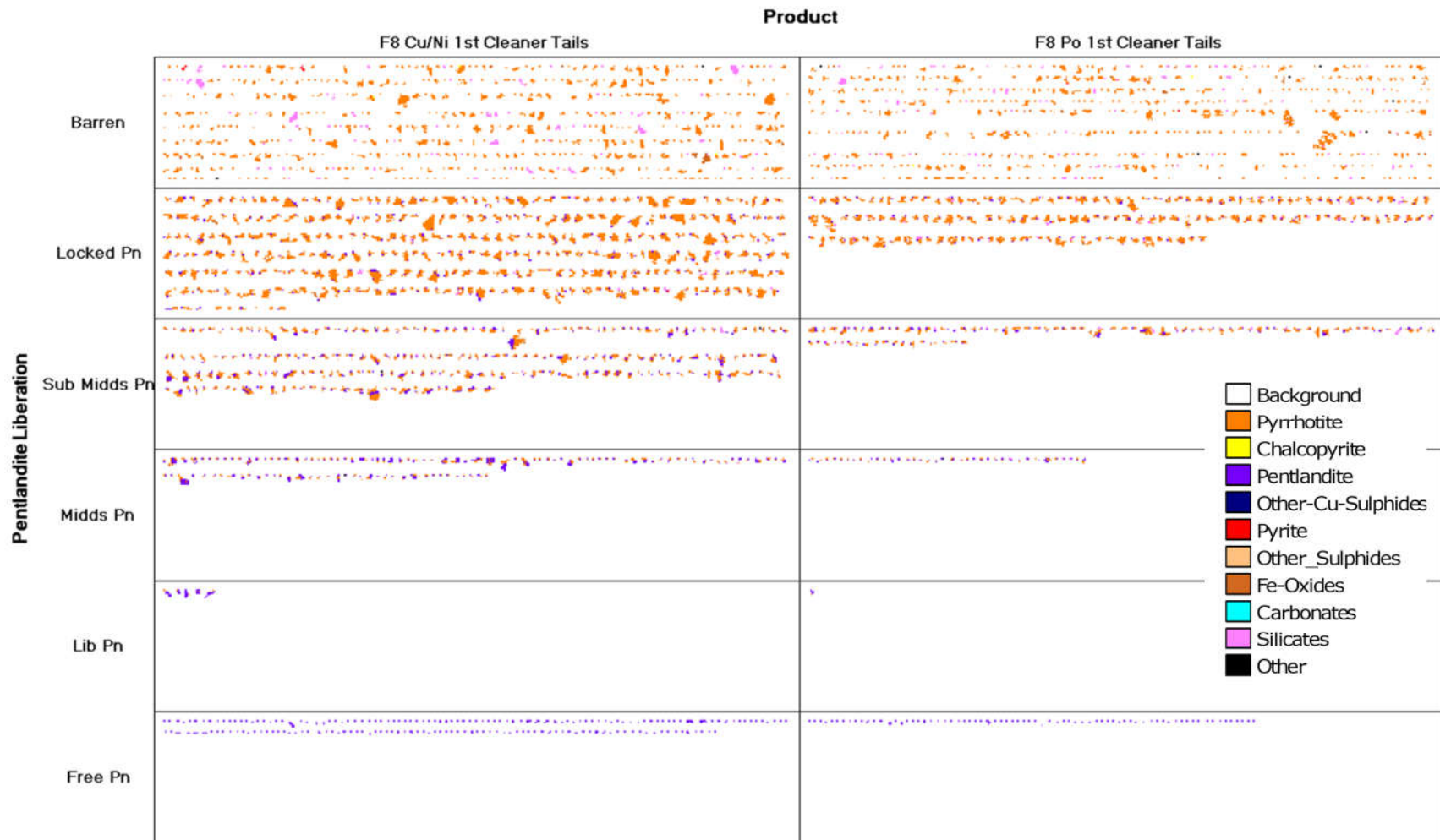

Figure 20: Image Grid: Pentlandite Association of Test F-8 Cu/Ni 1st Cleaner Tails and Po 1st Cleaner Tails

Conclusions and Recommendations

The following can be concluded:

- The Phikwe -Selebi samples received for this testwork program contained 1.07% copper and 1.17% nickel in the SN Comp, high copper grade in the S Comp (1.90% Cu, 0.88% Ni), and low copper grade in the P Comp (0.42% Cu, 0.79% Ni).
- Mineralogy showed that chalcopyrite, pentlandite, and pyrrhotite were the major sulphide minerals, along with lesser amounts of pyrite. Higher pyrrhotite was present in the SN Comp.
- Liberation of the chalcopyrite was good at a grind size of 80% passing ~100 µm, but liberation of the pentlandite was poor at ~50-65% with strong associations with pyrrhotite. A fine regrind is required to liberate pentlandite.
- The proportion of total nickel in pentlandite was ~80%, with the majority (~15%) of the remaining nickel contained in pyrrhotite.
- The grindability tests indicated the Phikwe – Selebi samples were very soft to medium in hardness, and slightly abrasive. The Phikwe samples were slightly harder than the Selebi samples. The samples were softer at coarser grind sizes (SAG particle sizes), trending harder at finer grind sizes (ball mill particle sizes).
- The rougher kinetics performance of the SN Comp with a primary grind at a F₈₀ of ~100 µm was similar to those performed at the 160 µm and 70 µm. However, the mass pull and metal recoveries of the coarse grind (160 µm) test was lower.
- A dosage of 25 g/t diethylenetriamine (DETA) was required to depress pyrrhotite effectively in the Cu/Ni cleaners and Po cleaners, but low dosages of PAX were still required to maintain the selectivity. Higher dosages of DETA may depress pentlandite flotation.
- A polish grind and high dosage of lime (>500 g/t) were critical for depressing pentlandite during Cu-Ni separation circuit.
- The recovery of copper to the Cu concentrate was found to be 74-79% at a grade of 29-31% Cu, with an additional 15-19% recovered to the Ni concentrate. The nickel recovery to the Ni concentrate (combined Copper Rougher Scavenger Tails and Po 3rd Cleaner Concentrate) was 62-64% at a grade of 11-12% Ni.

Recommendations:

- Further flowsheet and reagent optimization should be completed to better establish the limits to metallurgy. More representative samples should be provided for this testwork.
 - The lime dosage was critical for pentlandite depression in the Cu-Ni separation stage. It is recommended to perform further tests to evaluate the minimum dosage required.

- Pentlandite flotation was sensitive to the lime dosage. It is recommended to investigate a lower lime dosage in the Cu/Ni rougher and cleaner stages to maximize the nickel recovery.
- Repeat test F-40, to evaluate the flowsheet developed for Selkirk Samples.
- Variability testing should be considered.
 - Hardness characteristics as a function of sulphur head grade should be examined.
 - Flotation evaluation of varying head grades to better understand grade-recovery relationships and dosing strategies for reagents, which will be critical for the successful operation of a future commercial processing plant.
- Environmental testing in support of a tailings management plan.
- Solid-liquid separation testing on various streams to help size thickeners, pumps, and filters.

Appendix A – Sample Receipt and Preparation

18559-01

18-Jun-21

Sample Preparation Diagram - SN Comp

Note: No hazards that are known, other than silica

ID	Instruction	Est Wt. kg
D15551	include entire sample	9.1
D15553	include entire sample	5.9
D15554	include entire sample	10.7
D15555	include entire sample	12.6
D15558	include entire sample	10.5
D15559	include entire sample	10.3
D15560	include entire sample	7.2
D15561	include entire sample	7.9
D15562	include entire sample	8.0
D15563	incl. 2.00 kg, store rem.	2.0
D15564	incl. 6.00 kg, store rem.	6.0
D15565	include entire sample	7.8
D15567	include entire sample	10.4
D15568	incl. 7.00 kg, store rem.	7.0
D15569	incl. 6.00 kg, store rem.	6.0
TOTAL		121.4

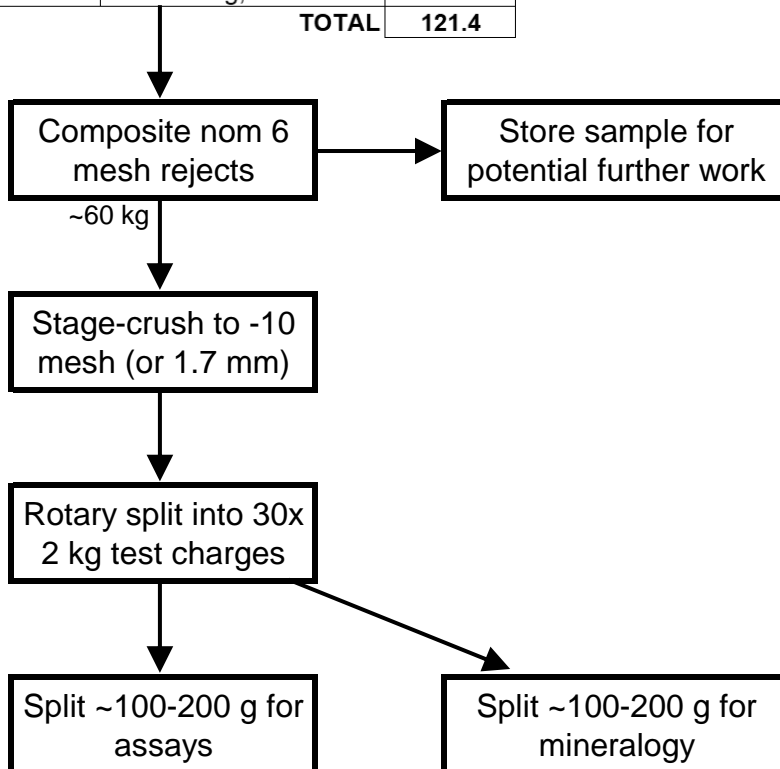

18559-01

18-Jun-21

Sample Preparation Diagram - P Comp

Note: No hazards that are known, other than silica

ID	Instruction	Est Wt. kg
D15570	include entire sample	14.7
D15571	include entire sample	14.6
D15572	include entire sample	15.0
D15573	include entire sample	15.0
D15581	include entire sample	5.6
D15574	incl. 5.00 kg, store rem.	5.0
D15577	include entire sample	7.4
TOTAL		77.3

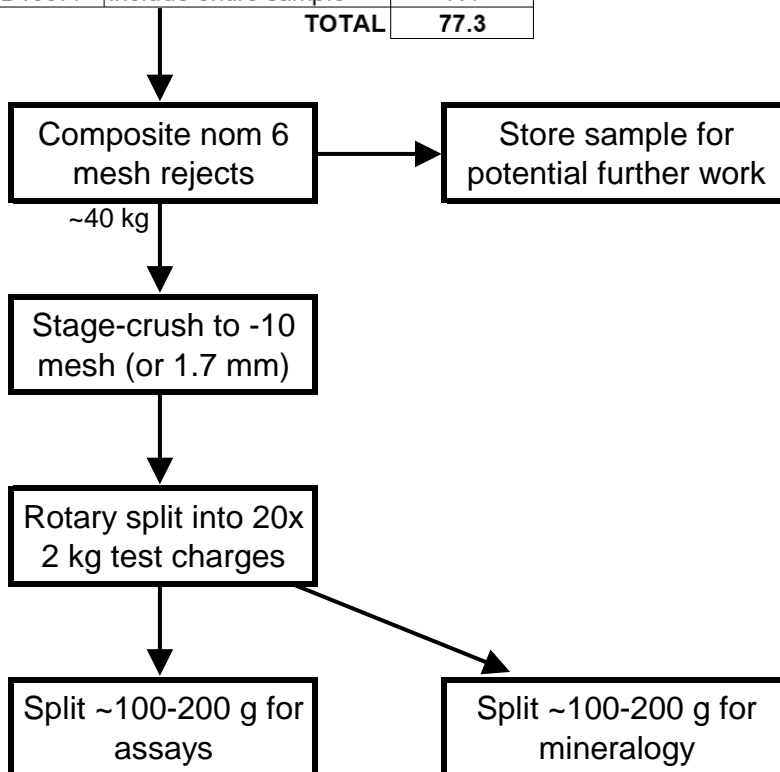

18559-01

18-Jun-21

Sample Preparation Diagram - S Comp

Note: No hazards that are known, other than silica

ID	Instruction	Est Wt. kg
D15579	include entire sample	14.3
D15580	incl. 3.00 kg, store rem.	3.0
D15582	include entire sample	14.8
D15583	include entire sample	14.6
D15584	include entire sample	14.8
D15587	include entire sample	14.1
D15588	include entire sample	14.1
D15590	include entire sample	8.8
TOTAL		98.5

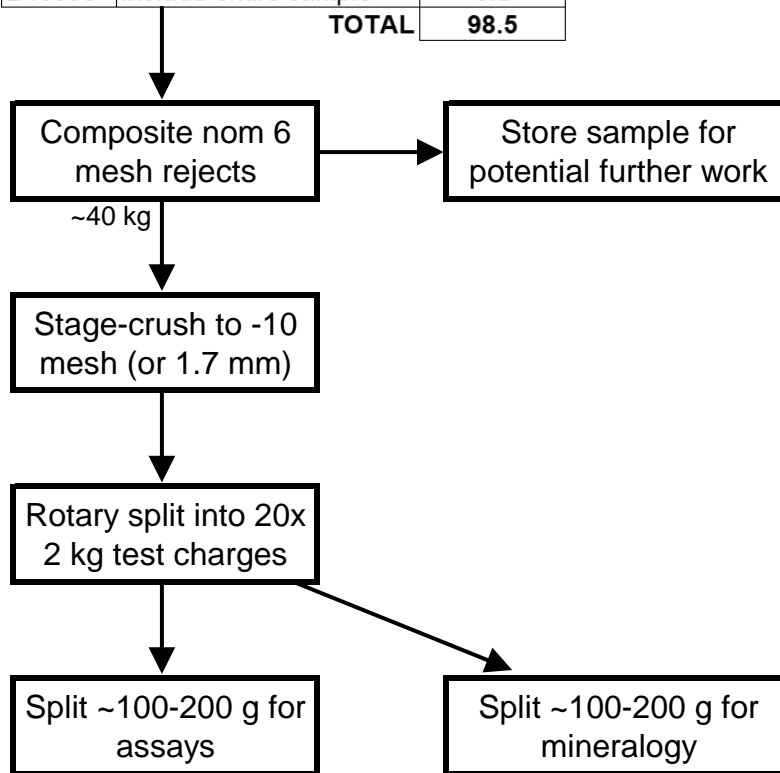

18559-01

28-Jun-21

Sample Preparation Diagram - SN Comp

Note: No hazards that are known, other than silica

ID	Instruction	Est Wt. kg
D15551	include entire sample	3.2
D15553	include entire sample	2.1
D15554	include entire sample	4.2
D15555	include entire sample	4.4
D15558	include entire sample	3.7
D15559	include entire sample	3.5
D15560	include entire sample	2.5
D15561	include entire sample	2.7
D15562	include entire sample	2.7
D15563	incl. 0.7 kg, store rem.	0.7
D15564	incl. 2.2 kg, store rem.	2.2
D15565	include entire sample	2.7
D15567	include entire sample	4.1
D15568	incl. 2.4 kg, store rem.	2.4
D15569	incl. 2.1 kg, store rem.	2.1
TOTAL		43.2

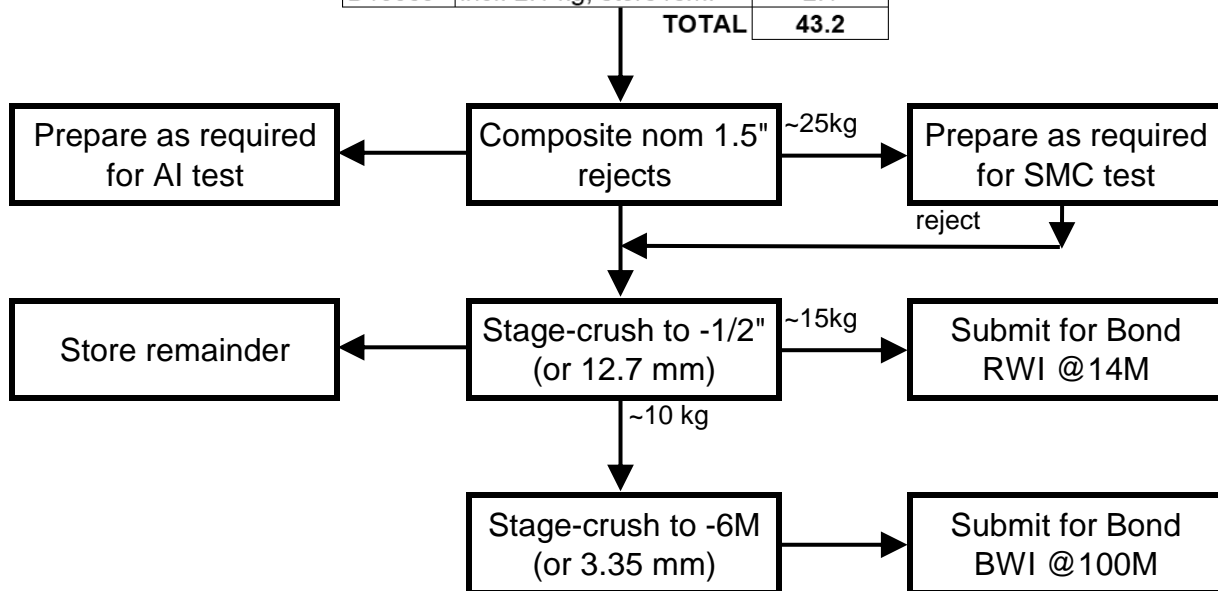

18559-01

28-Jun-21

Sample Preparation Diagram - P Comp

Note: No hazards that are known, other than silica

ID	Instruction	Est Wt. kg
D15570	include entire sample	5.5
D15571	include entire sample	5.2
D15572	include entire sample	5.6
D15573	include entire sample	5.6
D15581	include entire sample	2.0
D15574	incl. 1.9 kg, store rem.	1.9
D15577	include entire sample	2.5
TOTAL		28.3

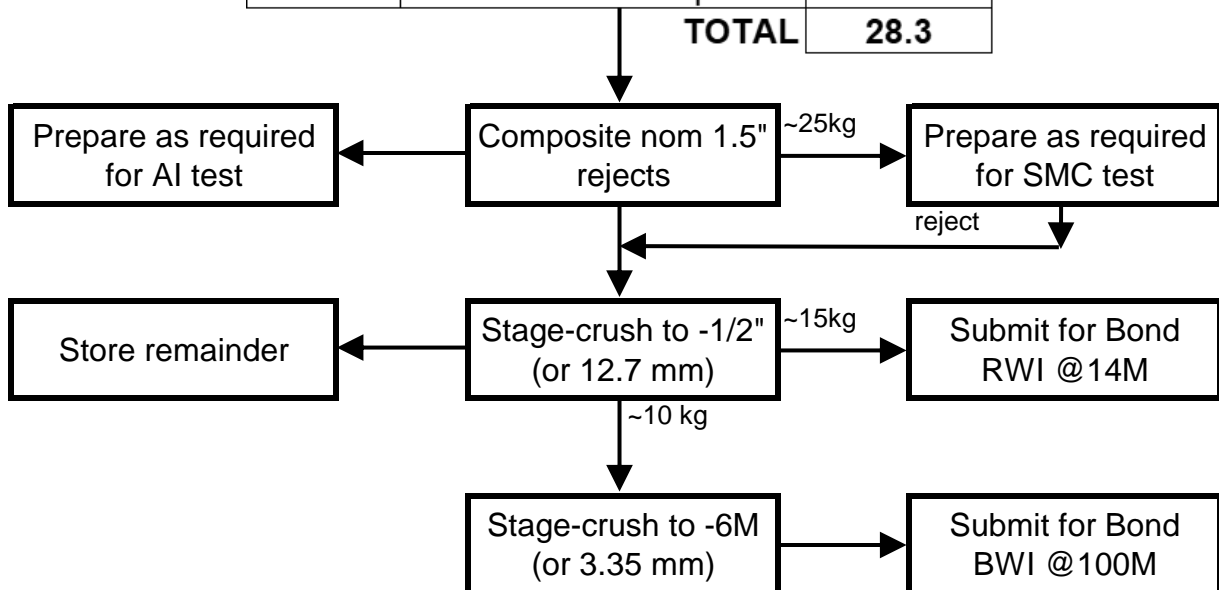

18559-01

28-Jun-21

Sample Preparation Diagram - S Comp

Note: No hazards that are known, other than silica

ID	Instruction	Est Wt. kg
D15579	include entire sample	5.5
D15580	incl. 1.1 kg, store rem.	1.1
D15582	include entire sample	5.5
D15583	include entire sample	5.0
D15584	include entire sample	5.0
D15587	include entire sample	5.0
D15588	include entire sample	5.0
D15590	include entire sample	3.6
TOTAL		35.7

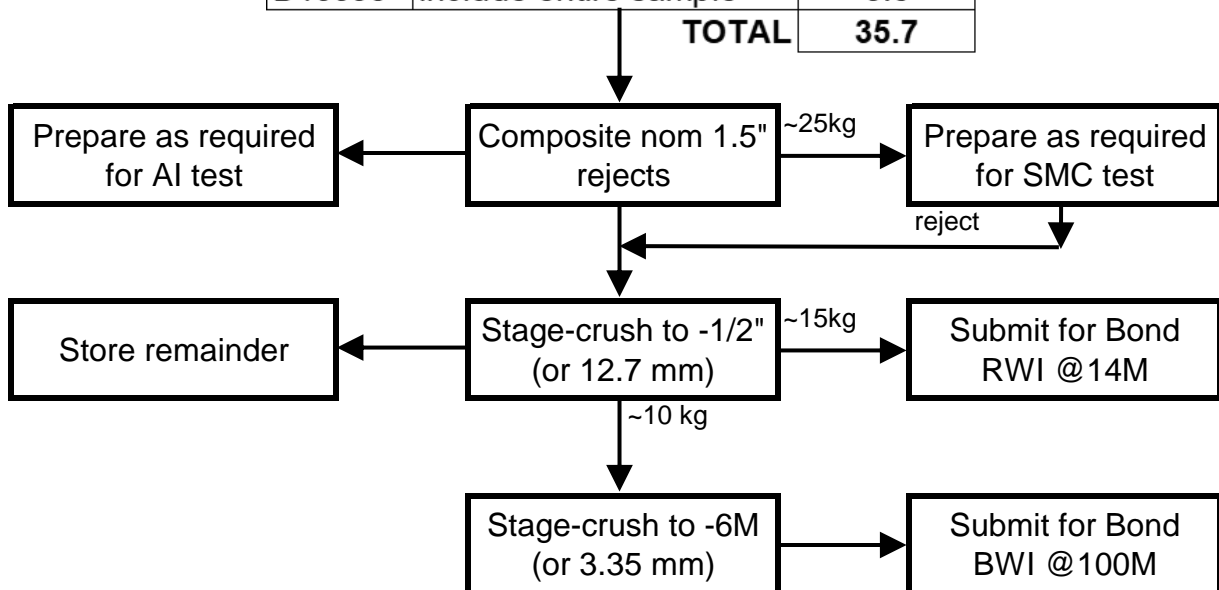

Appendix B – Head Characterization

SGS Canada Inc.
 P.O. Box 4300 - 185 Concession St.
 Lakefield - Ontario - KOL 2HO
 Phone: 705-652-2000 FAX: 705-652-6365

LR Internal Dept 14
 Attn : D. Imeson

28-June-2021

Date Rec. : 10 June 2021
LR Report : CA02461-JUN21
Project : CA20M-00000-110-18559-0
 1

CERTIFICATE OF ANALYSIS

Final Report

Sample ID	Cu %	Ni %	S %
1: D15551	1.08	2.30	33.3
2: D15552	0.86	2.44	35.7
3: D15553	0.68	2.42	34.6
4: D15554	< 0.01	< 0.01	0.14
5: D15555	1.11	2.24	33.1
6: D15556	1.21	2.46	36.1
7: D15558	0.41	0.40	5.78
8: D15559	0.072	0.096	0.96
9: D15560	0.31	0.27	3.77
10: D15561	0.028	0.016	0.18
11: D15562	1.10	0.97	15.2
12: D15563	15.2	0.49	21.5
13: D15564	1.62	1.67	25.0
14: D15565	2.24	1.99	29.9
15: D15566	< 0.01	< 0.01	0.07
16: D15567	< 0.01	< 0.01	0.10
17: D15568	1.90	2.57	34.0
18: D15569	1.26	2.86	37.4
19: D15570	0.69	1.04	14.5
20: D15571	0.41	0.94	12.3

Control Quality Analysis
 Not suitable for commercial exchange

**SGS Canada Inc.**

P.O. Box 4300 - 185 Concession St.

Lakefield - Ontario - KOL 2H0

Phone: 705-652-2000 FAX: 705-652-6365

LR Report : CA02461-JUN21

Sarah Thyret-Arbour
Technologist, Mineral Services, Analytical

SGS Canada Inc.
P.O. Box 4300 - 185 Concession St.
Lakefield - Ontario - KOL 2HO
Phone: 705-652-2000 FAX: 705-652-6365

LR Internal Dept 14
Attn : D. Imeson

28-June-2021

Date Rec. : 10 June 2021
LR Report : CA02462-JUN21
Project : CA20M-00000-110-18559-0
1

CERTIFICATE OF ANALYSIS

Final Report

Sample ID	Cu %	Ni %	S %
1: D15572	0.29	1.05	14.0
2: D15573	0.26	0.91	11.7
3: D15581	0.064	0.012	0.12
4: D15574	< 0.01	< 0.01	0.04
5: D15575	< 0.01	< 0.01	0.05
6: D15576	0.16	0.24	2.41
7: D15577	0.94	0.35	4.71
8: D15578	20.2	0.88	32.2
9: D15579	0.28	3.09	35.0
10: D15580	16.0	1.24	31.5
11: D15582	2.90	0.72	11.0
12: D15583	3.28	0.74	11.9
13: D15584	2.84	0.68	10.3
14: D15585	3.98	0.22	6.43
15: D15586	< 0.01	< 0.01	0.04
16: D15587	< 0.01	< 0.01	0.06
17: D15588	0.17	0.073	0.60
18: D15589	0.10	0.063	0.28
19: D15590	0.098	0.68	7.44

Control Quality Assay
Not Suitable for Commercial Exchange

Sarah Thyret-Arbour
Technologist, Mineral Services, Analytical



QEMSCAN DATA

prepared for:

North American Nickel

Project 18559-01

MI5046-JUN21

July 14, 2021

Prepared by:



Margot Aldis/Chris Gunning
Mineralogist/Senior Mineralogist

High Definition Mineralogical Analysis using QEMSCAN (Quantitative Evaluation of Materials by Scanning Electron Microscopy) (METH# 8.11.1) used by SGS Minerals Services

SGS Canada

P.O. Box 4300, 185 Concession Street, Lakefield, Ontario, Canada K0L 2H0
Tel. (705) 652-6365 www.sgs.com www.sgs.com/met

Member of the SGS Group (SGS SA)

North American Nickel
 18559-01
 MI5046-JUN21

High Definition Mineralogical Analysis using QEMSCAN (Quantitative Evaluation of Materials by Scanning Electron Microscopy)

Assay Reconciliation

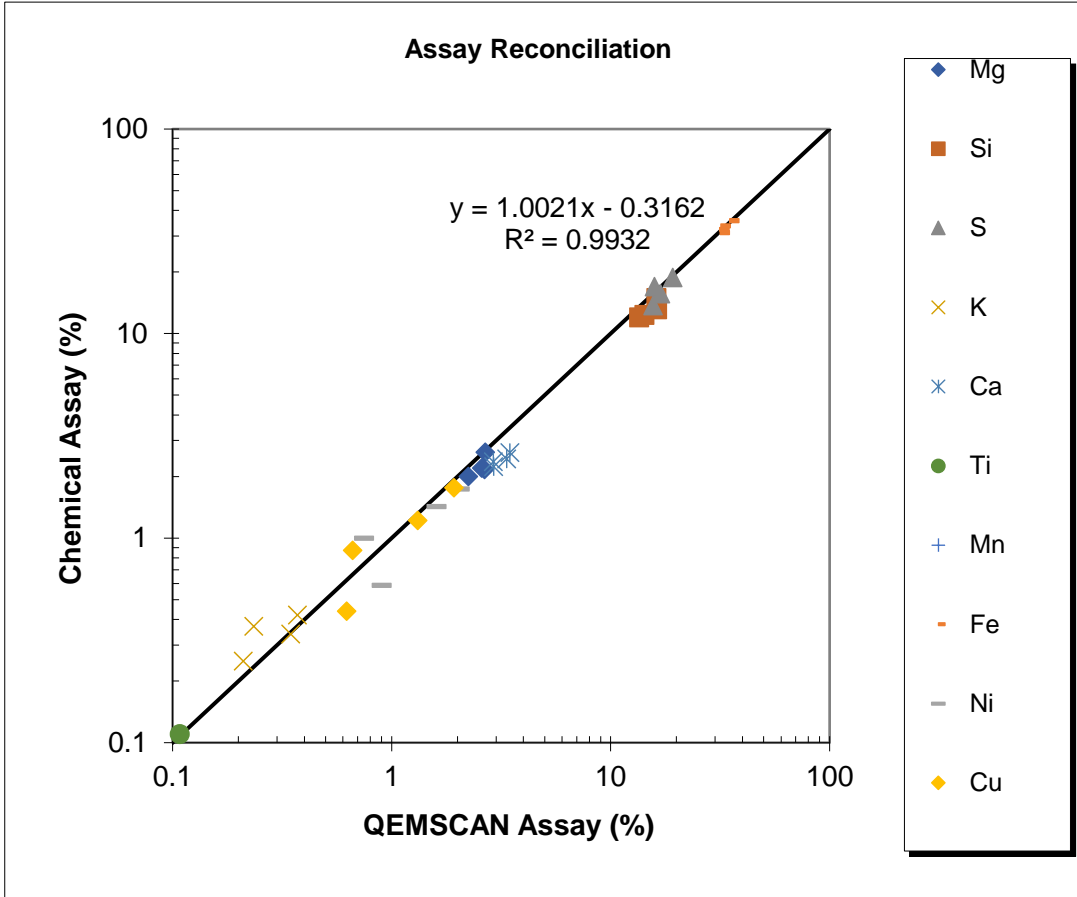

Sample	SN Comp 30 Min				
	Combined	+106um	-106/+53um	-53/+20um	-20um
Mg (QEMSCAN)	2.55	2.67	2.66	2.24	2.58
Mg (Chemical)	2.24	2.63	2.17	2.00	2.20
Si (QEMSCAN)	15.23	16.19	16.32	13.53	14.29
Si (Chemical)	13.08	14.90	13.10	12.00	12.30
S (QEMSCAN)	16.79	15.63	15.85	19.24	16.88
S (Chemical)	16.39	13.70	17.00	18.80	15.70
K (QEMSCAN)	0.30	0.37	0.35	0.21	0.24
K (Chemical)	0.34	0.42	0.34	0.25	0.37
Ca (QEMSCAN)	3.19	3.46	3.35	2.93	2.91
Ca (Chemical)	2.42	2.62	2.44	2.24	2.36
Ti (QEMSCAN)	0.09	0.08	0.11	0.08	0.07
Ti (Chemical)	0.13	0.14	0.11	0.10	0.16
Mn (QEMSCAN)	0.09	0.07	0.07	0.07	0.17
Mn (Chemical)	0.08	0.09	0.08	0.07	0.08
Fe (QEMSCAN)	32.43	31.61	31.85	34.97	31.56
Fe (Chemical)	33.31	31.20	33.70	35.70	32.40
Ni (QEMSCAN)	1.26	0.90	0.75	1.61	2.05
Ni (Chemical)	1.17	0.59	1.00	1.43	1.74
Cu (QEMSCAN)	1.07	0.62	0.66	1.32	1.93
Cu (Chemical)	1.05	0.44	0.87	1.22	1.76

North American Nickel
18559-01
MI5046-JUN21

High Definition Mineralogical Analysis using QEMSCAN (Quantitative
Evaluation of Materials by Scanning Electron Microscopy)

Modals

Survey		18559-01 / MI5046-JUN21									
Project		North American Nickel									
Sample		SN Comp 30 Min									
Fraction		Combined	+106um		-106/+53um		-53/+20um		-20um		
Mass Size Distribution (%)			22.3		33.6		22.4		21.7		
Calculated ESD Particle Size		22	60		62		22		8		
Mineral	Mass (%)	Sample	Sample	Fraction	Sample	Fraction	Sample	Fraction	Sample	Fraction	
Pyrrhotite		37.03	8.04	36.04	12.41	36.92	9.36	41.80	7.22	33.29	
Chalcopyrite		3.10	0.40	1.80	0.64	1.91	0.85	3.80	1.21	5.56	
Pentlandite		3.13	0.47	2.11	0.55	1.65	0.92	4.09	1.19	5.47	
Pyrite/Marcasite		0.12	0.02	0.10	0.04	0.11	0.03	0.15	0.03	0.14	
Other_Sulphides		0.04	0.01	0.05	0.01	0.02	0.00	0.02	0.02	0.08	
Fe-Oxides		6.25	1.54	6.90	2.27	6.75	1.33	5.96	1.11	5.12	
Other_Oxides		0.15	0.03	0.12	0.08	0.23	0.03	0.13	0.01	0.07	
Chlorite/Clays		7.90	1.60	7.16	2.21	6.58	1.42	6.33	2.67	12.31	
Biotite		1.77	0.48	2.16	0.79	2.36	0.26	1.16	0.24	1.10	
Talc		0.17	0.01	0.05	0.02	0.04	0.04	0.17	0.11	0.50	
Quartz		7.71	1.76	7.89	2.91	8.66	1.55	6.94	1.49	6.85	
Plagioclase		10.22	2.49	11.17	3.68	10.94	2.12	9.48	1.93	8.88	
Amphibole/Pyroxene		20.57	4.93	22.10	7.42	22.07	4.14	18.46	4.09	18.85	
K-Feldspar		0.65	0.20	0.89	0.24	0.71	0.11	0.48	0.10	0.48	
Epidote		0.56	0.16	0.70	0.15	0.44	0.11	0.50	0.14	0.65	
Titanite/sphene		0.10	0.02	0.09	0.02	0.06	0.02	0.08	0.04	0.18	
Other Silicates		0.34	0.11	0.51	0.15	0.45	0.06	0.25	0.02	0.09	
Carbonates		0.02	0.00	0.01	0.01	0.02	0.01	0.03	0.01	0.03	
Apatite		0.11	0.03	0.14	0.01	0.04	0.02	0.11	0.04	0.18	
Other		0.06	0.01	0.03	0.01	0.02	0.02	0.07	0.04	0.16	
Total		100.00	22.30	100.0	33.60	100.0	22.40	100.0	21.70	100.0	
Mean Grain Size by Frequency (µm)											
Pyrrhotite		22	57		58		21		9		
Chalcopyrite		14	45		47		23		7		
Pentlandite		12	26		22		17		7		
Pyrite/Marcasite		12	38		38		16		5		
Other_Sulphides		5	14		8		5		4		
Fe-Oxides		24	56		57		18		9		
Other_Oxides		16	22		25		12		6		
Chlorite/Clays		9	18		16		9		5		
Biotite		18	29		31		13		7		
Talc		5	9		8		6		5		
Quartz		21	54		56		21		7		
Plagioclase		21	43		43		19		8		
Amphibole/Pyroxene		21	46		46		19		8		
K-Feldspar		10	15		12		9		6		
Epidote		8	18		13		7		5		
Titanite/sphene		7	11		10		8		6		
Other Silicates		10	13		12		6		5		
Carbonates		11	11		13		11		9		
Apatite		13	55		30		19		7		
Other		6	9		8		9		5		

North American Nickel
18559-01
MI5046-JUN21

High Definition Mineralogical Analysis using QEMSCAN (Quantitative Evaluation of Materials by Scanning Electron Microscopy)

Cu Department

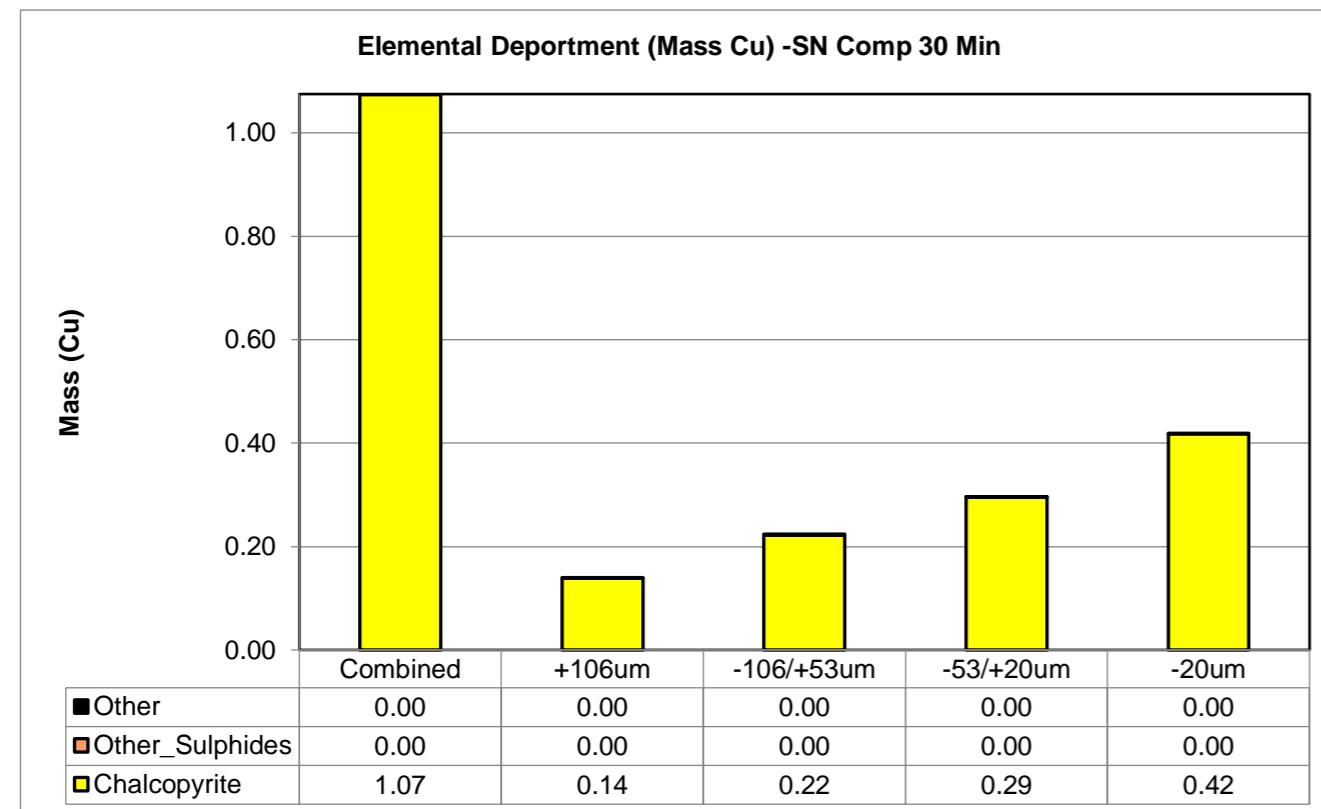

Elemental Department (Mass Cu)

Mineral Name	Combined	+106um	-106/+53um	-53/+20um	-20um
Chalcopyrite	1.07	0.14	0.22	0.29	0.42
Other_Sulphides	0.00	0.00	0.00	0.00	0.00
Other	0.00	0.00	0.00	0.00	0.00
Total	1.07	0.14	0.22	0.30	0.42
Total (% in fraction)	100.00	12.94	20.72	27.46	38.88

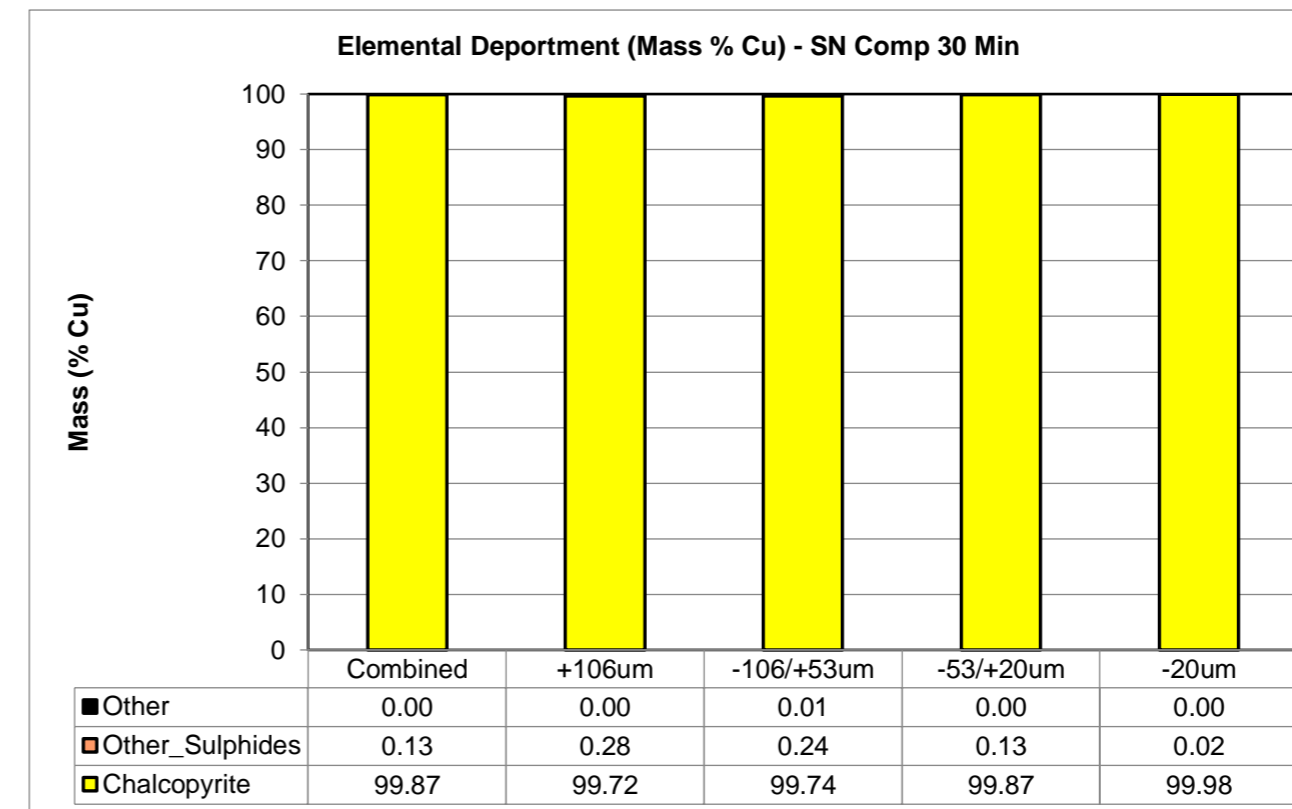

Elemental Department (Mass % Cu)

Mineral Name	Combined	+106um	-106/+53um	-53/+20um	-20um
Chalcopyrite	99.87	99.72	99.74	99.87	99.98
Other_Sulphides	0.13	0.28	0.24	0.13	0.02
Other	0.00	0.00	0.01	0.00	0.00
Total	100.00	100.00	100.00	100.00	100.00

North American Nickel
 18559-01
 MI5046-JUN21

High Definition Mineralogical Analysis using QEMSCAN (Quantitative Evaluation of Materials by Scanning Electron Microscopy)

Ni Department

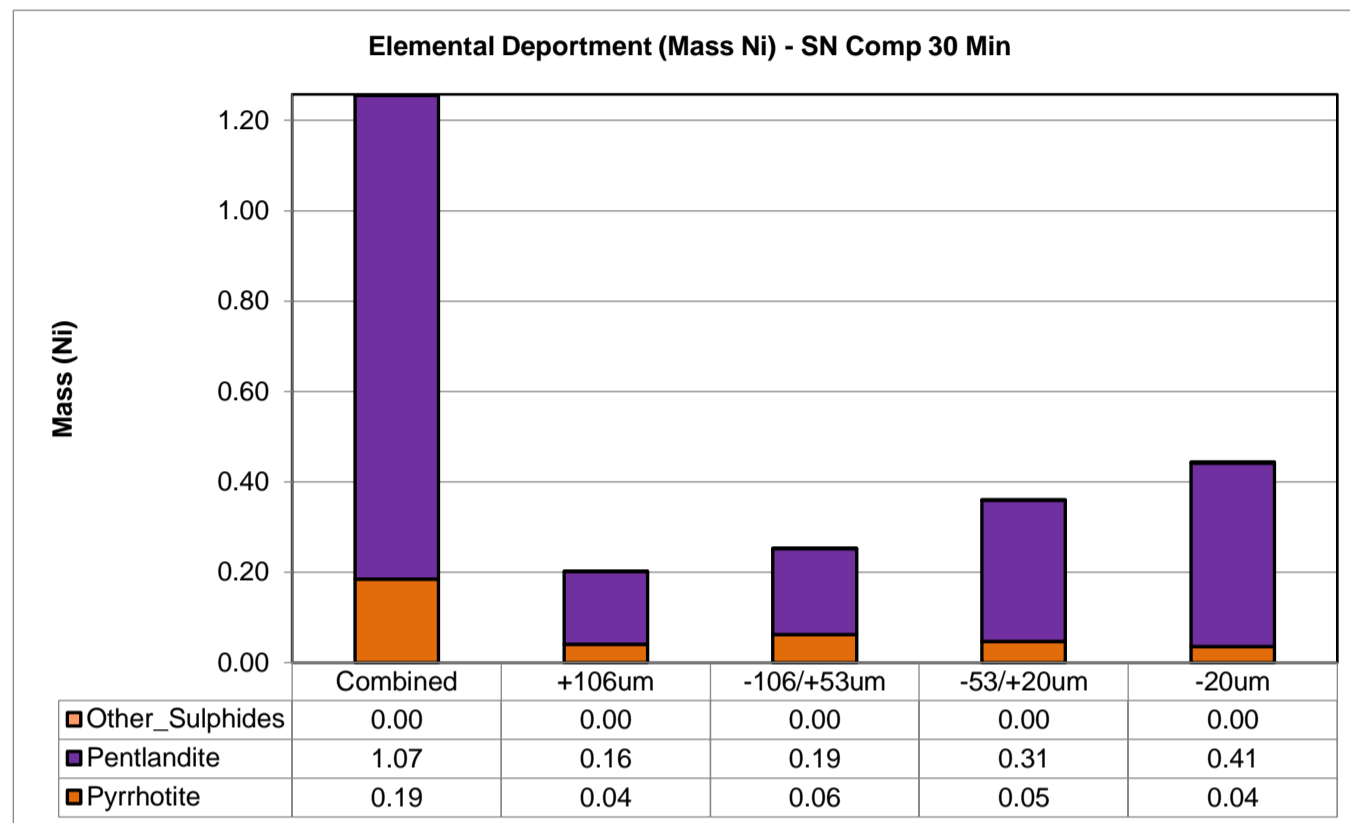

Elemental Department (Mass Ni)

Mineral Name	Combined	+106um	-106/+53um	-53/+20um	-20um
Pyrrhotite	0.19	0.04	0.06	0.05	0.04
Pentlandite	1.07	0.16	0.19	0.31	0.41
Other_Sulphides	0.00	0.00	0.00	0.00	0.00
Total	1.26	0.20	0.25	0.36	0.44
Total (% in fraction)	100.00	16.00	20.01	28.63	35.35

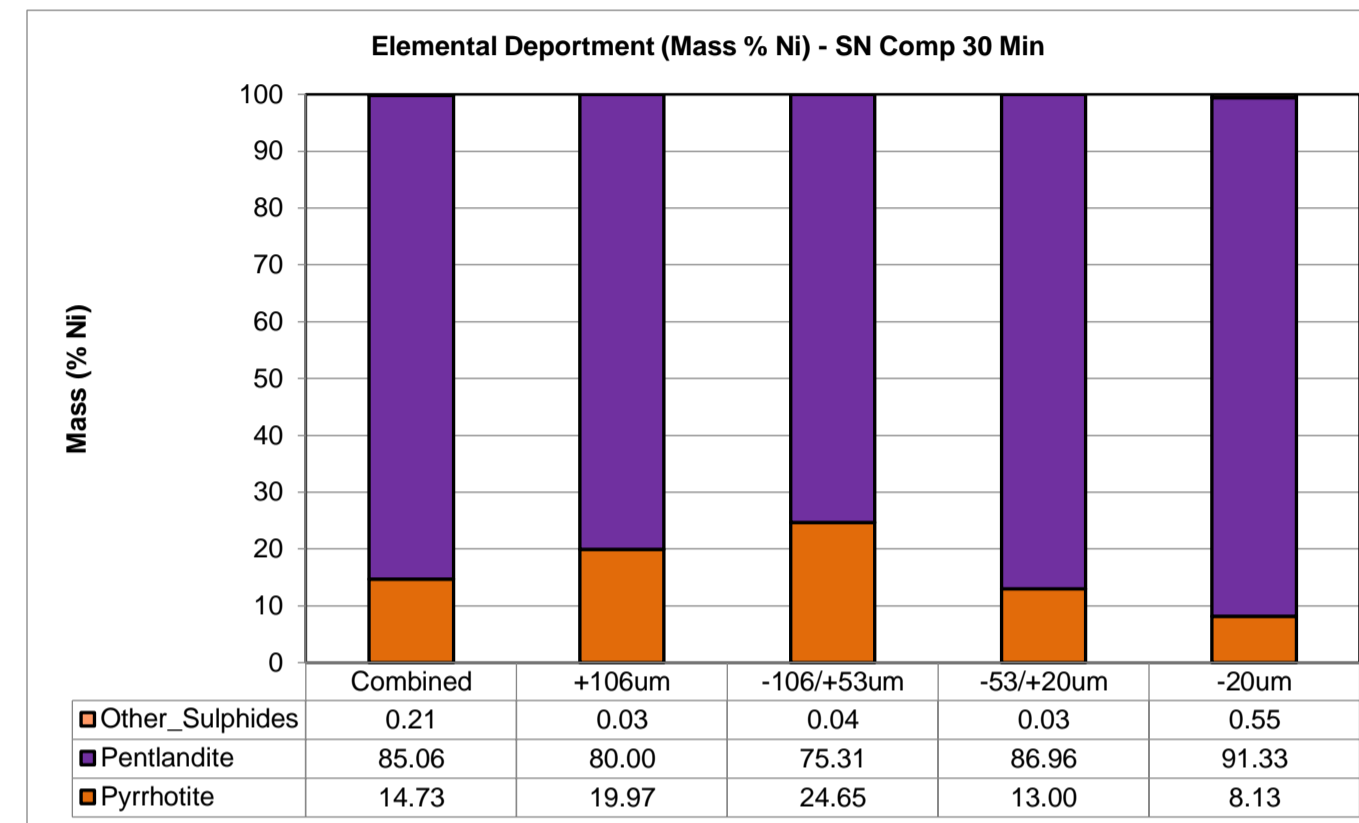

Elemental Department (Mass % Ni)

Mineral Name	Combined	+106um	-106/+53um	-53/+20um	-20um
Pyrrhotite	14.73	19.97	24.65	13.00	8.13
Pentlandite	85.06	80.00	75.31	86.96	91.33
Other_Sulphides	0.21	0.03	0.04	0.03	0.55
Total	100.00	100.00	100.00	100.00	100.00

North American Nickel
 18559-01
 MI5046-JUN21

High Definition Mineralogical Analysis using QEMSCAN (Quantitative Evaluation of Materials by Scanning Electron Microscopy)

Pentlandite Liberation

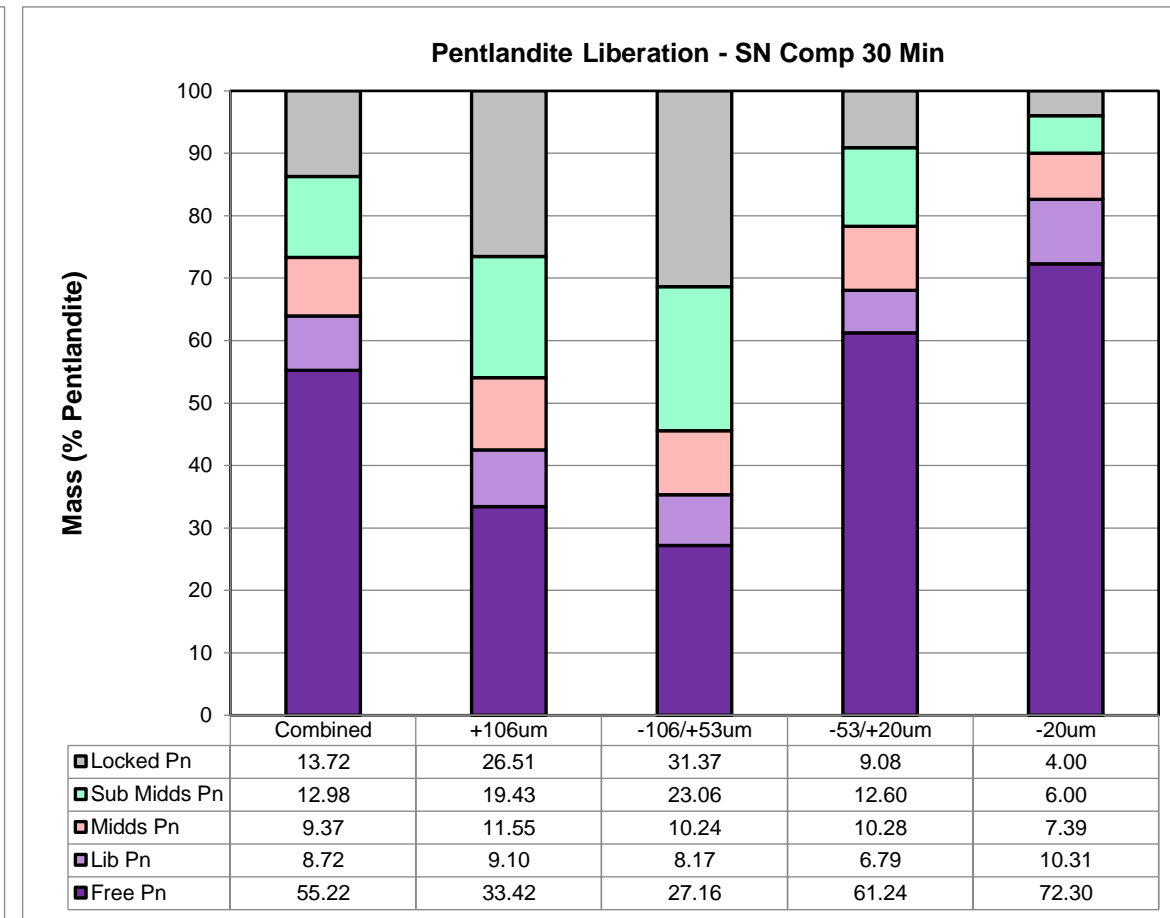
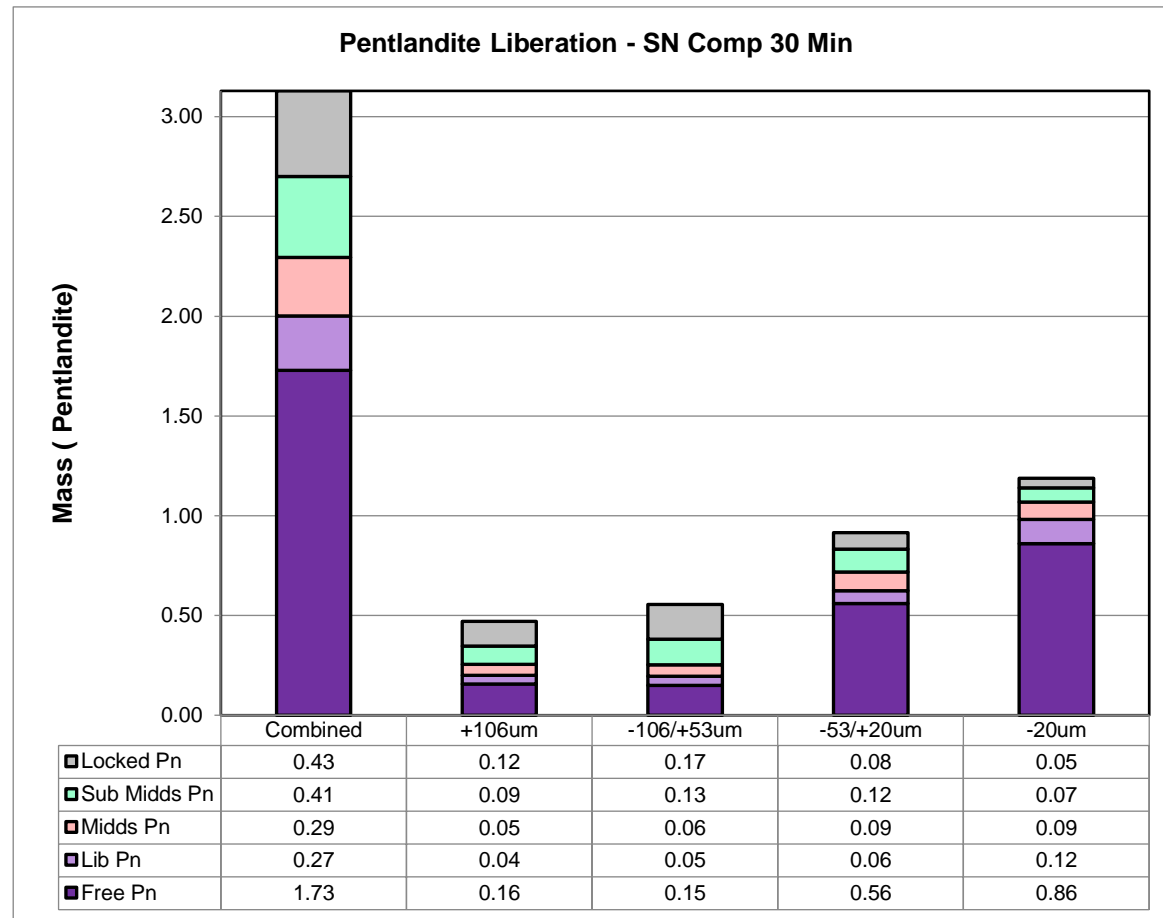

Absolute Mass of Pentlandite Across Fraction

Mineral Name	Combined	+106um	-106/+53um	-53/+20um	-20um
Free Pn	1.73	0.16	0.15	0.56	0.86
Lib Pn	0.27	0.04	0.05	0.06	0.12
Mids Pn	0.29	0.05	0.06	0.09	0.09
Sub Mids Pn	0.41	0.09	0.13	0.12	0.07
Locked Pn	0.43	0.12	0.17	0.08	0.05
Total	3.13	0.47	0.55	0.92	1.19
Total (% in fraction)	100.0	15.1	17.7	29.3	38.0

Normalized Mass of Pentlandite Across Fraction

Mineral Name	Combined	+106um	-106/+53um	-53/+20um	-20um
Free Pn	55.22	33.42	27.16	61.24	72.30
Lib Pn	8.72	9.10	8.17	6.79	10.31
Mids Pn	9.37	11.55	10.24	10.28	7.39
Sub Mids Pn	12.98	19.43	23.06	12.60	6.00
Locked Pn	13.72	26.51	31.37	9.08	4.00
Total	100.0	100.0	100.0	100.0	100.0

North American Nickel
18559-01
MI5046-JUN21

High Definition Mineralogical Analysis using QEMSCAN (Quantitative Evaluation of Materials by Scanning Electron Microscopy)

Pentlandite Association

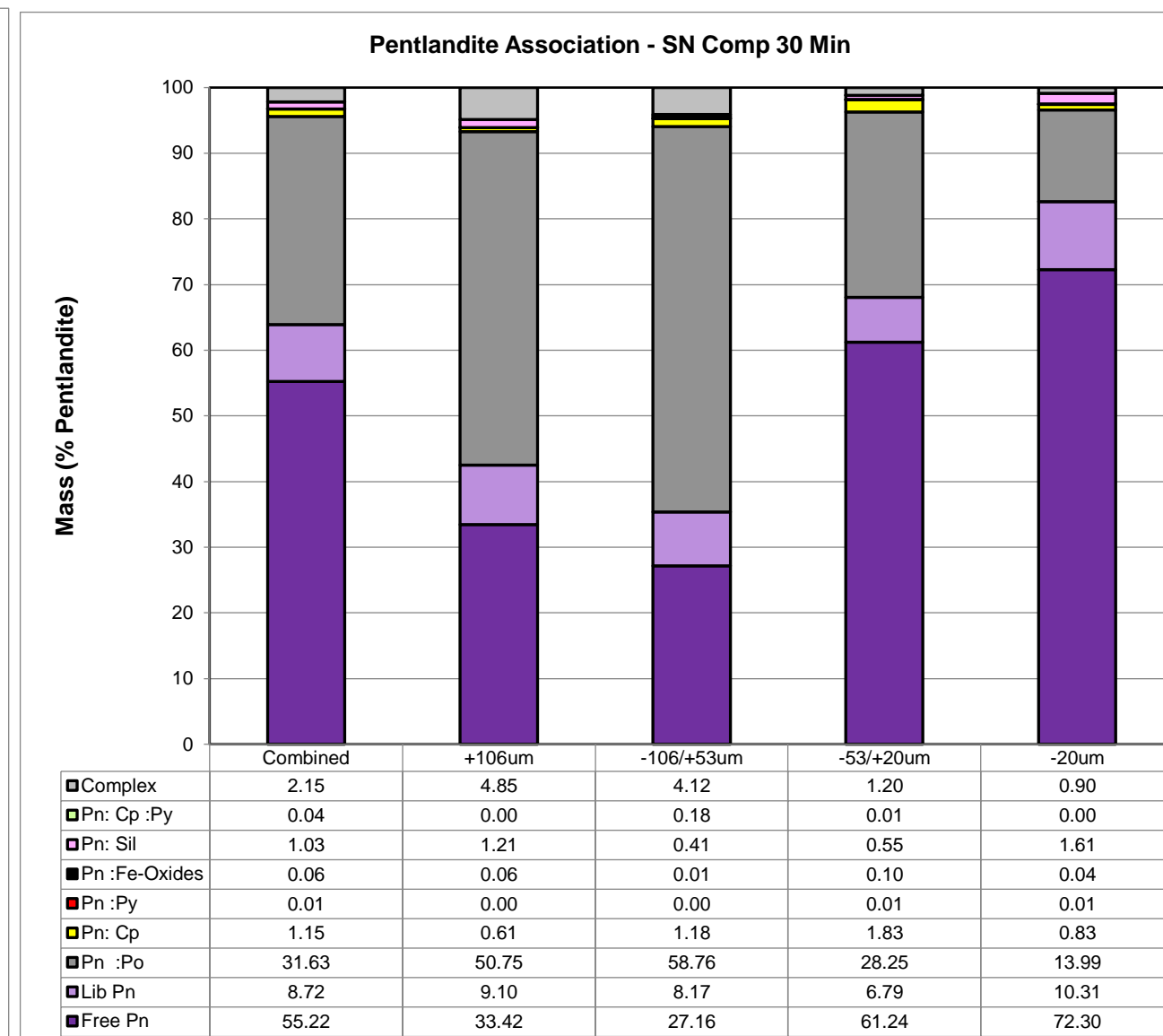
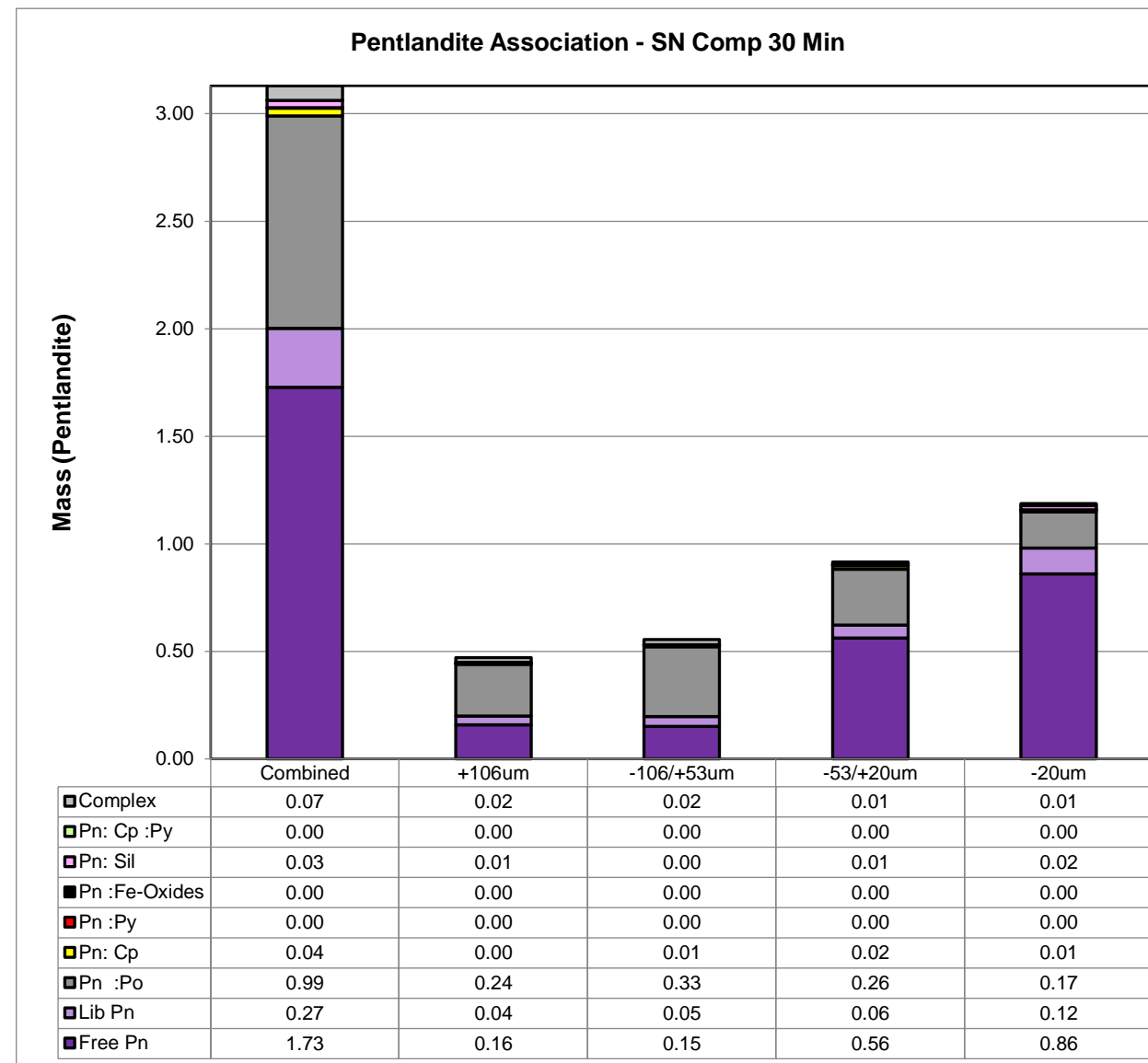

Absolute Mass of Pentlandite Across Fraction

Mineral Name	Combined	+106um	-106/+53um	-53/+20um	-20um
Free Pn	1.73	0.16	0.15	0.56	0.86
Lib Pn	0.27	0.04	0.05	0.06	0.12
Pn :Po	0.99	0.24	0.33	0.26	0.17
Pn: Cp	0.04	0.00	0.01	0.02	0.01
Pn :Py	0.00	0.00	0.00	0.00	0.00
Pn :Fe-Oxides	0.00	0.00	0.00	0.00	0.00
Pn: Sil	0.03	0.01	0.00	0.01	0.02
Pn: Cp :Py	0.00	0.00	0.00	0.00	0.00
Complex	0.07	0.02	0.02	0.01	0.01
Total	3.13	0.47	0.55	0.92	1.19
Total (% in fraction)	100.0	15.1	17.7	29.3	38.0

Normalized Mass of Pentlandite Across Fraction

Mineral Name	Combined	+106um	-106/+53um	-53/+20um	-20um
Free Pn	55.22	33.42	27.16	61.24	72.30
Lib Pn	8.72	9.10	8.17	6.79	10.31
Pn :Po	31.63	50.75	58.76	28.25	13.99
Pn: Cp	1.15	0.61	1.18	1.83	0.83
Pn :Py	0.01	0.00	0.00	0.01	0.01
Pn :Fe-Oxides	0.06	0.06	0.01	0.10	0.04
Pn: Sil	1.03	1.21	0.41	0.55	1.61
Pn: Cp :Py	0.04	0.00	0.18	0.01	0.00
Complex	2.15	4.85	4.12	1.20	0.90
Total	100.0	100.0	100.0	100.0	100.0
Liberated	63.93407182	42.5146886	35.33442787	68.03659564	82.61122419

North American Nickel
18559-01
M15046-JUN21

High Definition Mineralogical Analysis using

Image Grid - Pentlandite Association

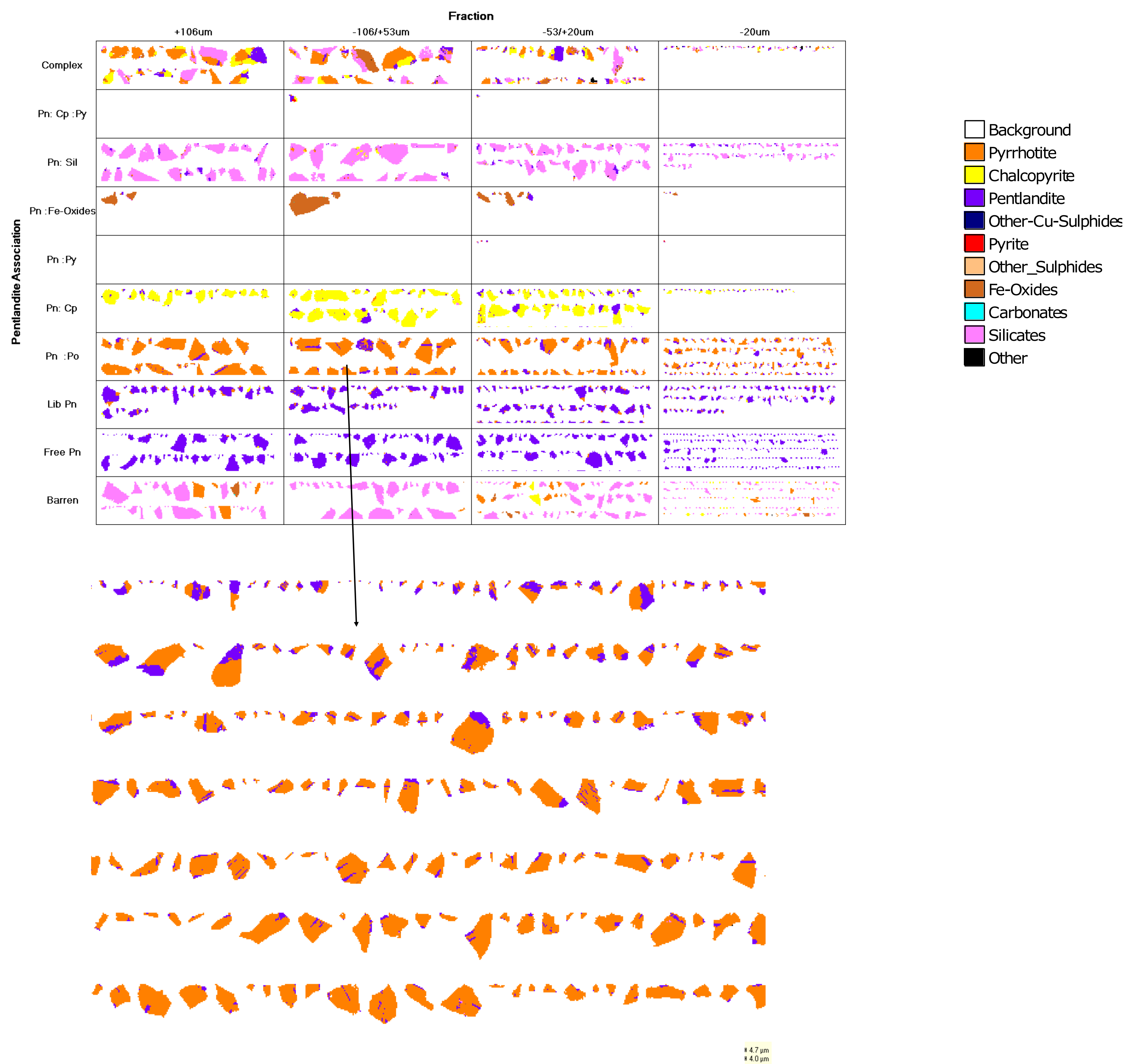

North American Nickel
18559-01
M15046-JUN21

High Definition Mineralogical Analysis using QEMSCAN (Quantitative
Evaluation of Materials by Scanning Electron Microscopy)

Pyrrhotite Liberation

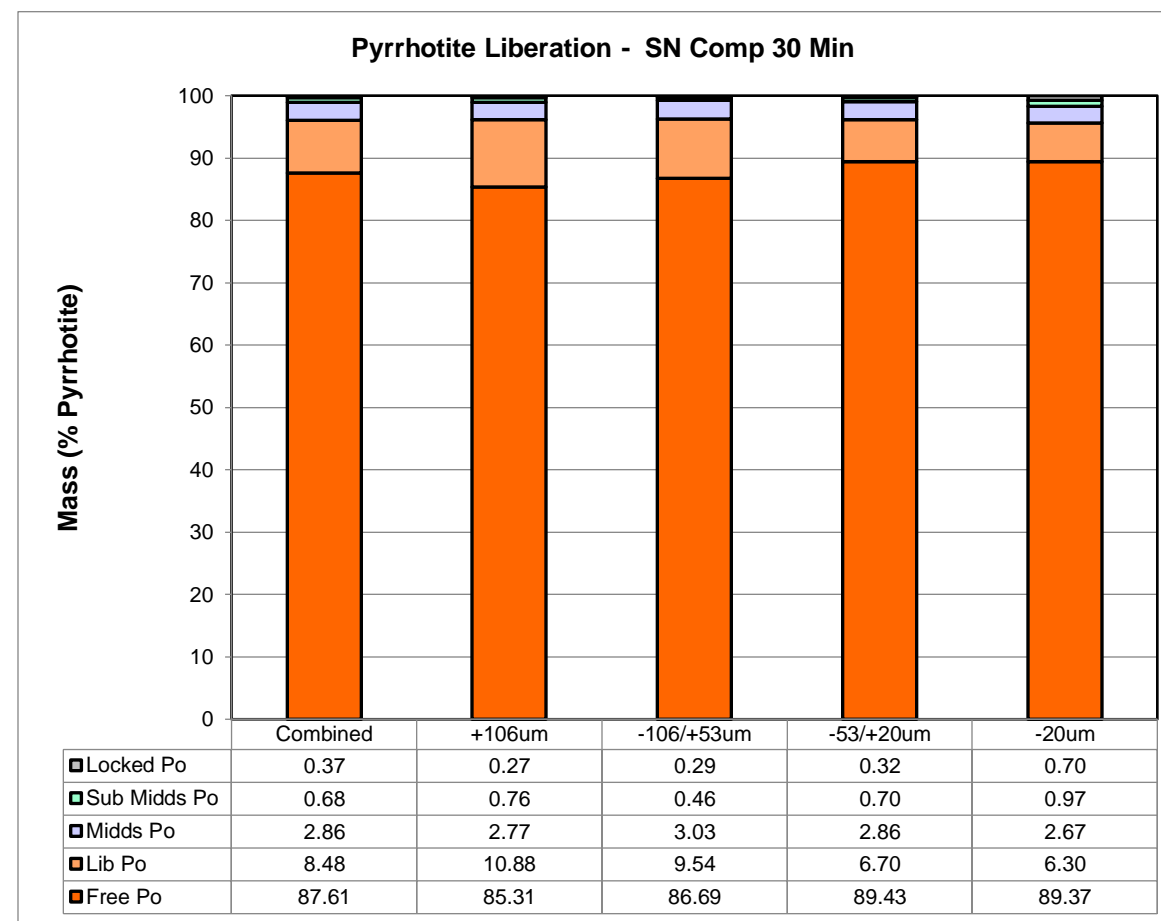
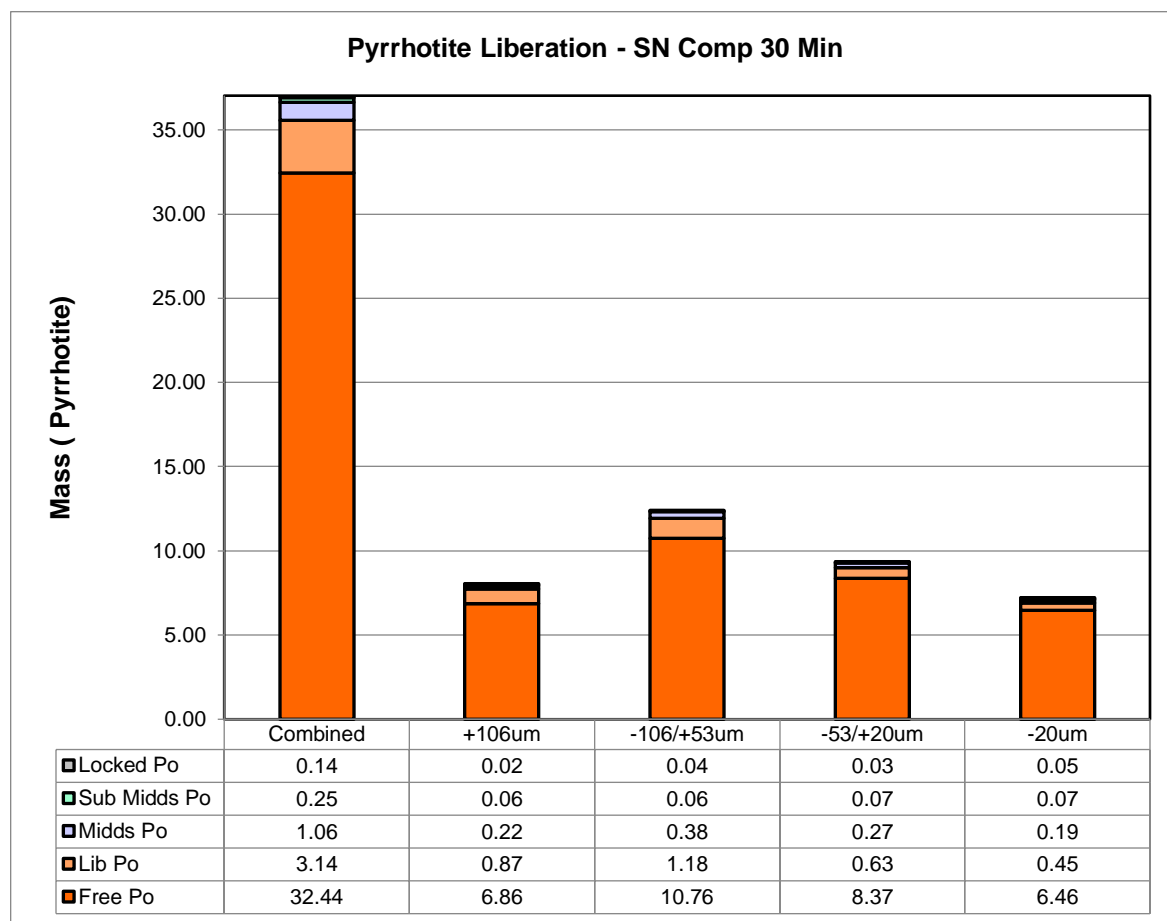

Absolute Mass of Pyrrhotite Across Fraction

Mineral Name	Combined	+106um	-106/+53um	-53/+20um	-20um
Free Po	32.44	6.86	10.76	8.37	6.46
Lib Po	3.14	0.87	1.18	0.63	0.45
Midds Po	1.06	0.22	0.38	0.27	0.19
Sub Midds Po	0.25	0.06	0.06	0.07	0.07
Locked Po	0.14	0.02	0.04	0.03	0.05
Total	37.03	8.04	12.41	9.36	7.22
Total (% in fraction)	100.0	21.7	33.5	25.3	19.5

Normalized Mass of Pyrrhotite Across Fraction

Mineral Name	Combined	+106um	-106/+53um	-53/+20um	-20um
Free Po	87.61	85.31	86.69	89.43	89.37
Lib Po	8.48	10.88	9.54	6.70	6.30
Midds Po	2.86	2.77	3.03	2.86	2.67
Sub Midds Po	0.68	0.76	0.46	0.70	0.97
Locked Po	0.37	0.27	0.29	0.32	0.70
Total	100.0	100.0	100.0	100.0	100.0

North American Nickel
 18559-01
 MI5046-JUN21

High Definition Mineralogical Analysis using QEMSCAN (Quantitative Evaluation of Materials by Scanning Electron Microscopy)

Pyrrhotite Association

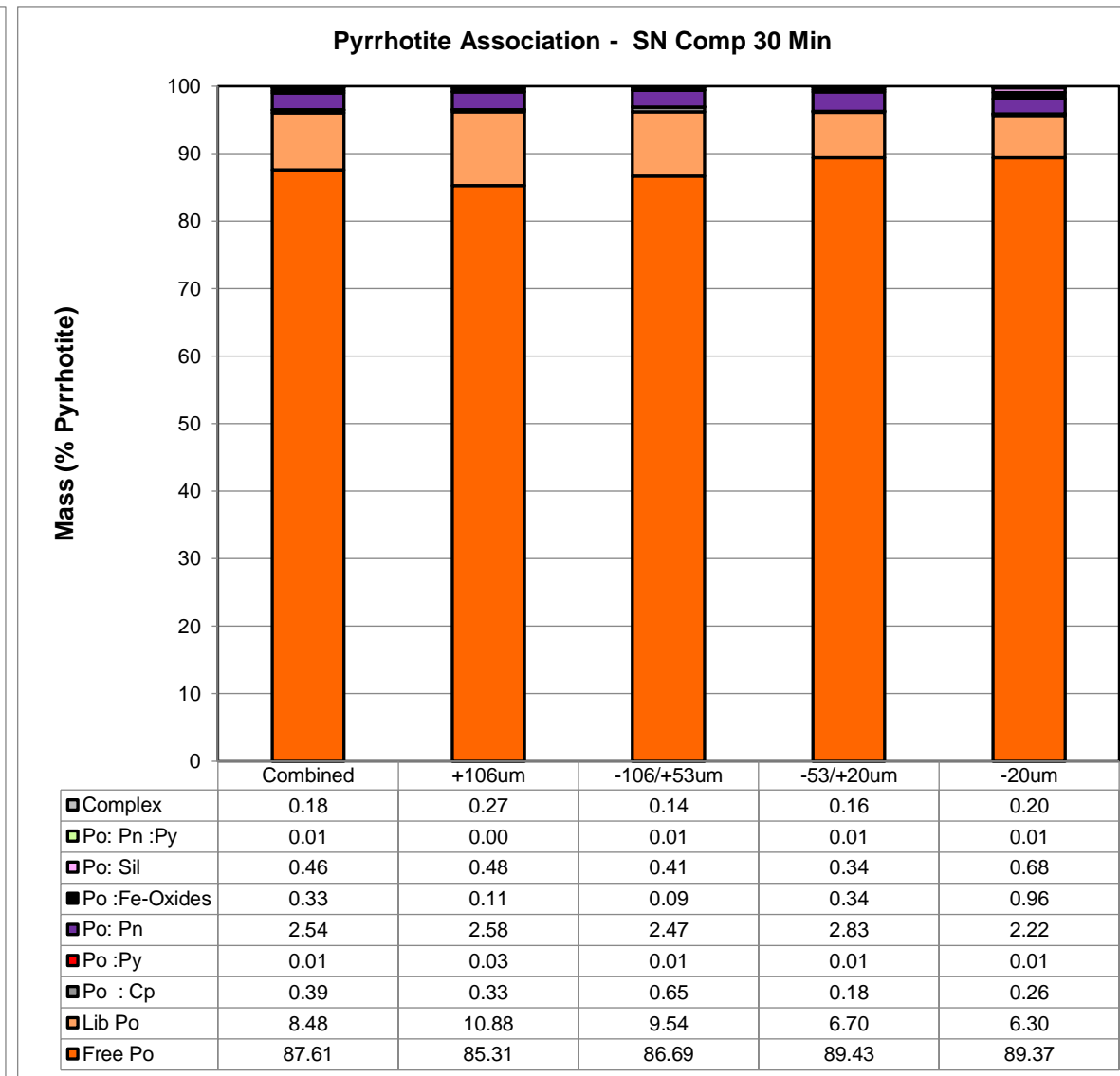
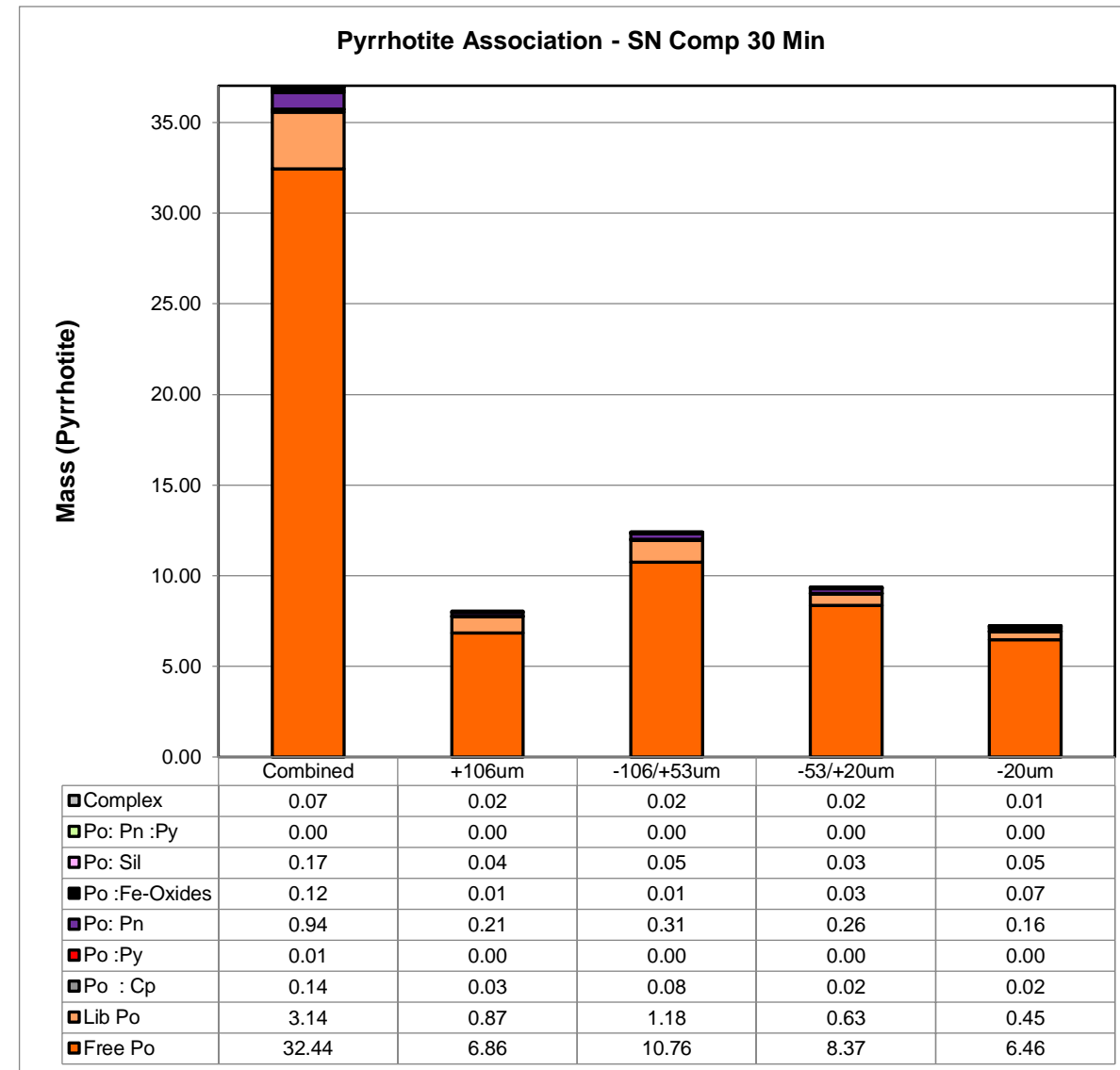

Absolute Mass of Pyrrhotite Across Fraction

Mineral Name	Combined	+106um	-106/+53um	-53/+20um	-20um
Free Po	32.44	6.86	10.76	8.37	6.46
Lib Po	3.14	0.87	1.18	0.63	0.45
Po : Cp	0.14	0.03	0.08	0.02	0.02
Po :Py	0.01	0.00	0.00	0.00	0.00
Po: Pn	0.94	0.21	0.31	0.26	0.16
Po :Fe-Oxides	0.12	0.01	0.01	0.03	0.07
Po: Sil	0.17	0.04	0.05	0.03	0.05
Po: Pn :Py	0.00	0.00	0.00	0.00	0.00
Complex	0.07	0.02	0.02	0.02	0.01
Total	37.03	8.04	12.41	9.36	7.22
Total (% in fraction)	100.0	21.7	33.5	25.3	19.5

Normalized Mass of Pyrrhotite Across Fraction

Mineral Name	Combined	+106um	-106/+53um	-53/+20um	-20um
Free Po	87.61	85.31	86.69	89.43	89.37
Lib Po	8.48	10.88	9.54	6.70	6.30
Po : Cp	0.39	0.33	0.65	0.18	0.26
Po :Py	0.01	0.03	0.01	0.01	0.01
Po: Pn	2.54	2.58	2.47	2.83	2.22
Po :Fe-Oxides	0.33	0.11	0.09	0.34	0.96
Po: Sil	0.46	0.48	0.41	0.34	0.68
Po: Pn :Py	0.01	0.00	0.01	0.01	0.01
Complex	0.18	0.27	0.14	0.16	0.20
Total	100.0	100.0	100.0	100.0	100.0
Liberated	96.08428918	96.18944627	96.22585375	96.13184862	95.66256752

North American Nickel
18559-01
M15046-JUN21

High Definition Mineralogical Analysis using

Image Grid - Pyrrhotite Association

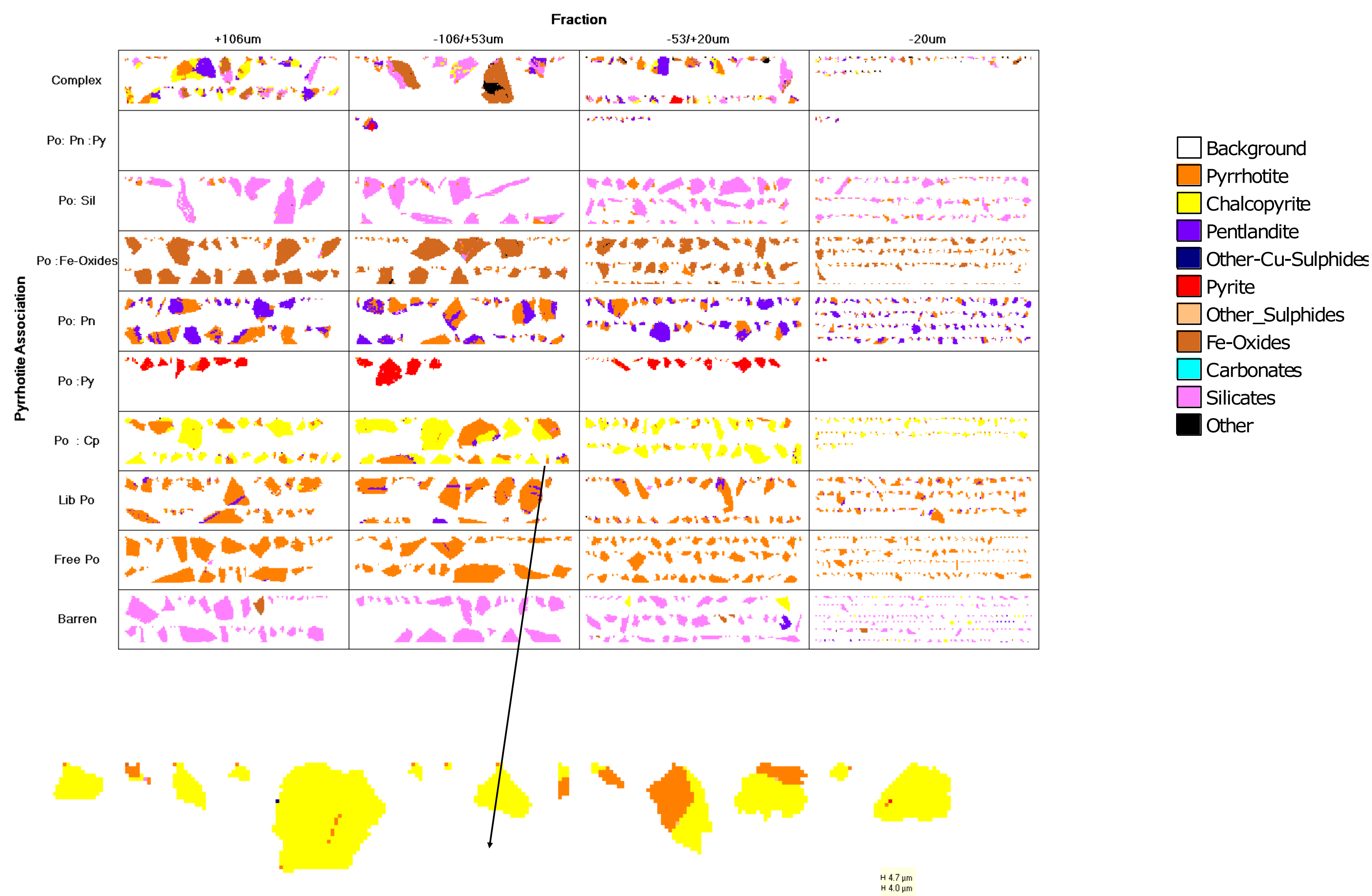

North American Nickel
 18559-01
 MI5046-JUN21

High Definition Mineralogical Analysis using QEMSCAN (Quantitative Evaluation of Materials by Scanning Electron Microscopy)

Chalcopyrite Liberation

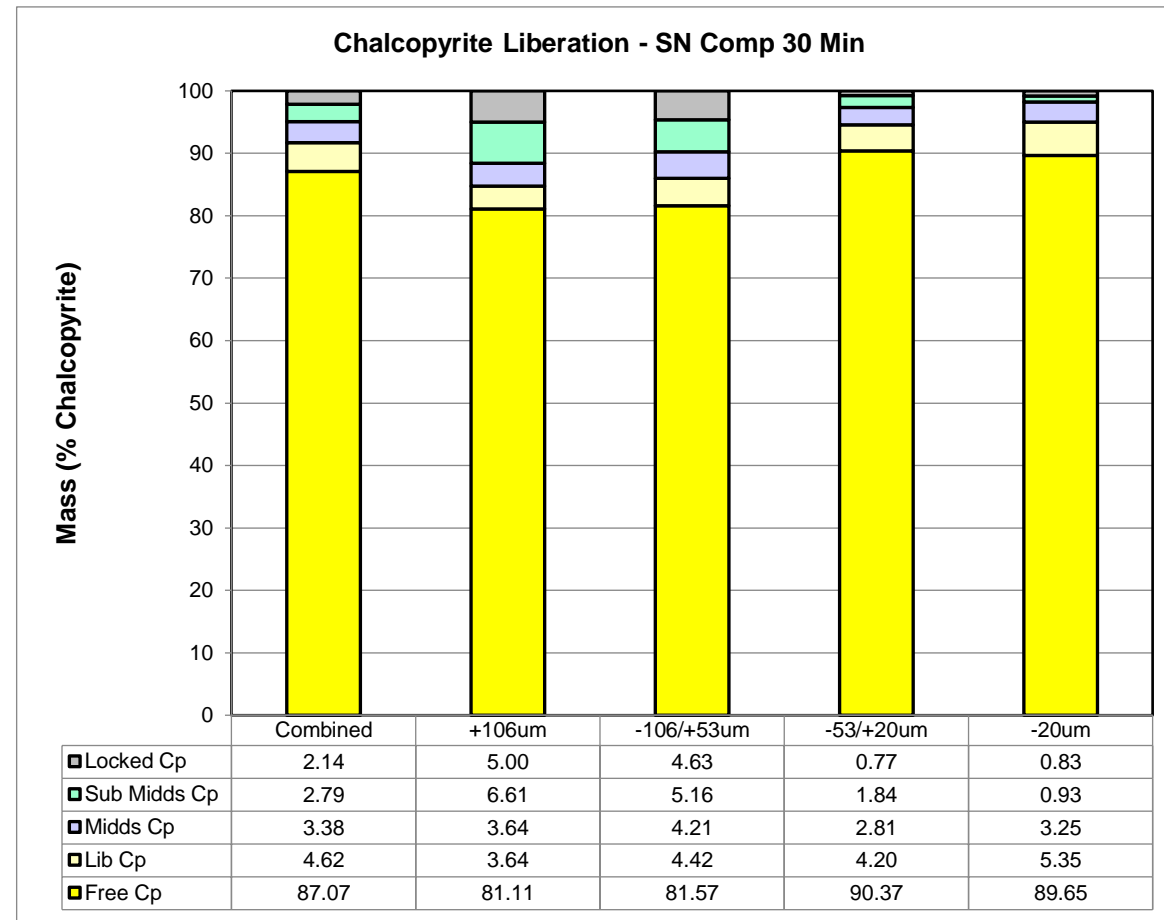
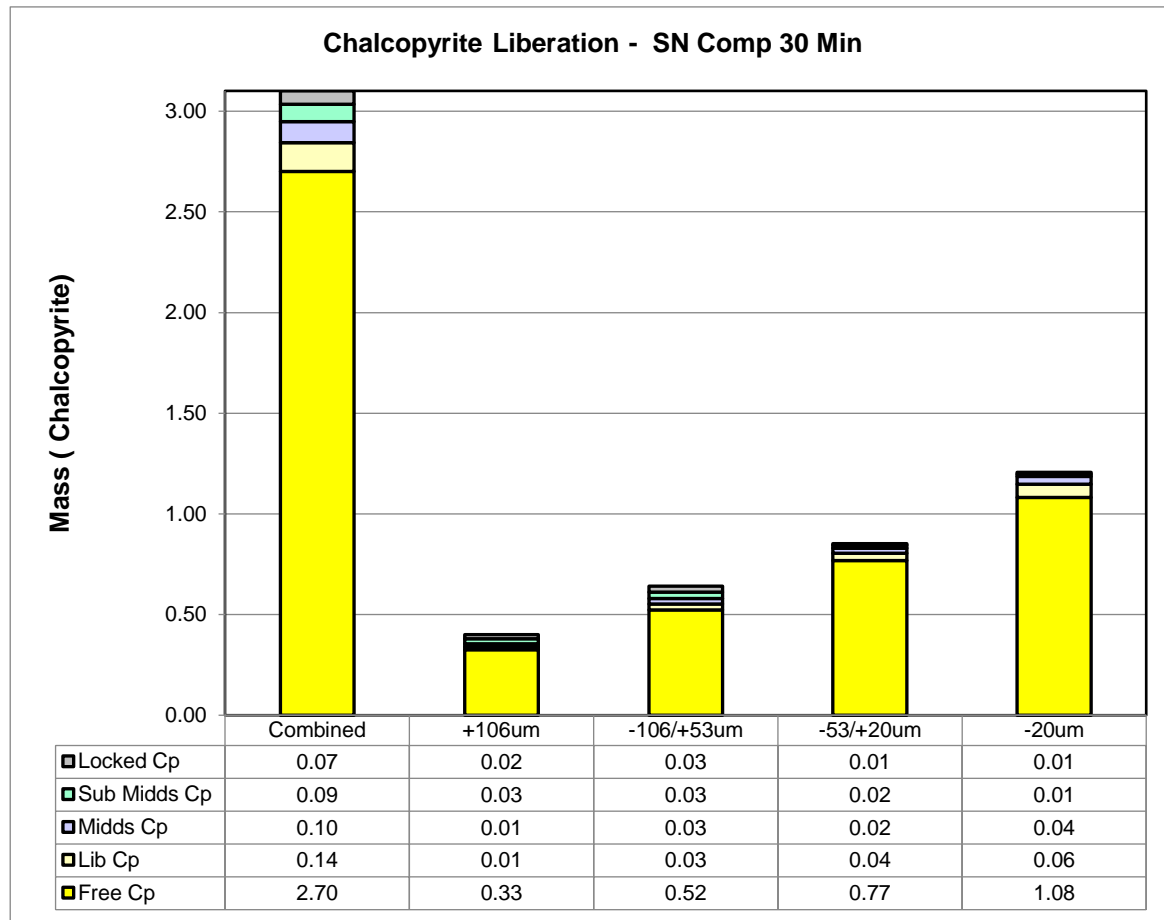

Absolute Mass of Chalcopyrite Across Fraction

Mineral Name	Combined	+106um	-106/+53um	-53/+20um	-20um
Free Cp	2.70	0.33	0.52	0.77	1.08
Lib Cp	0.14	0.01	0.03	0.04	0.06
Mids Cp	0.10	0.01	0.03	0.02	0.04
Sub Mids Cp	0.09	0.03	0.03	0.02	0.01
Locked Cp	0.07	0.02	0.03	0.01	0.01
Total	3.10	0.40	0.64	0.85	1.21
Total (% in fraction)	100.0	12.9	20.7	27.5	38.9

Normalized Mass of Chalcopyrite Across Fraction

Mineral Name	Combined	+106um	-106/+53um	-53/+20um	-20um
Free Cp	87.07	81.11	81.57	90.37	89.65
Lib Cp	4.62	3.64	4.42	4.20	5.35
Mids Cp	3.38	3.64	4.21	2.81	3.25
Sub Mids Cp	2.79	6.61	5.16	1.84	0.93
Locked Cp	2.14	5.00	4.63	0.77	0.83
Total	100.0	100.0	100.0	100.0	100.0

North American Nickel
 18559-01
 MI5046-JUN21

High Definition Mineralogical Analysis using QEMSCAN (Quantitative Evaluation of Materials by Scanning Electron Microscopy)

Chalcopyrite Association

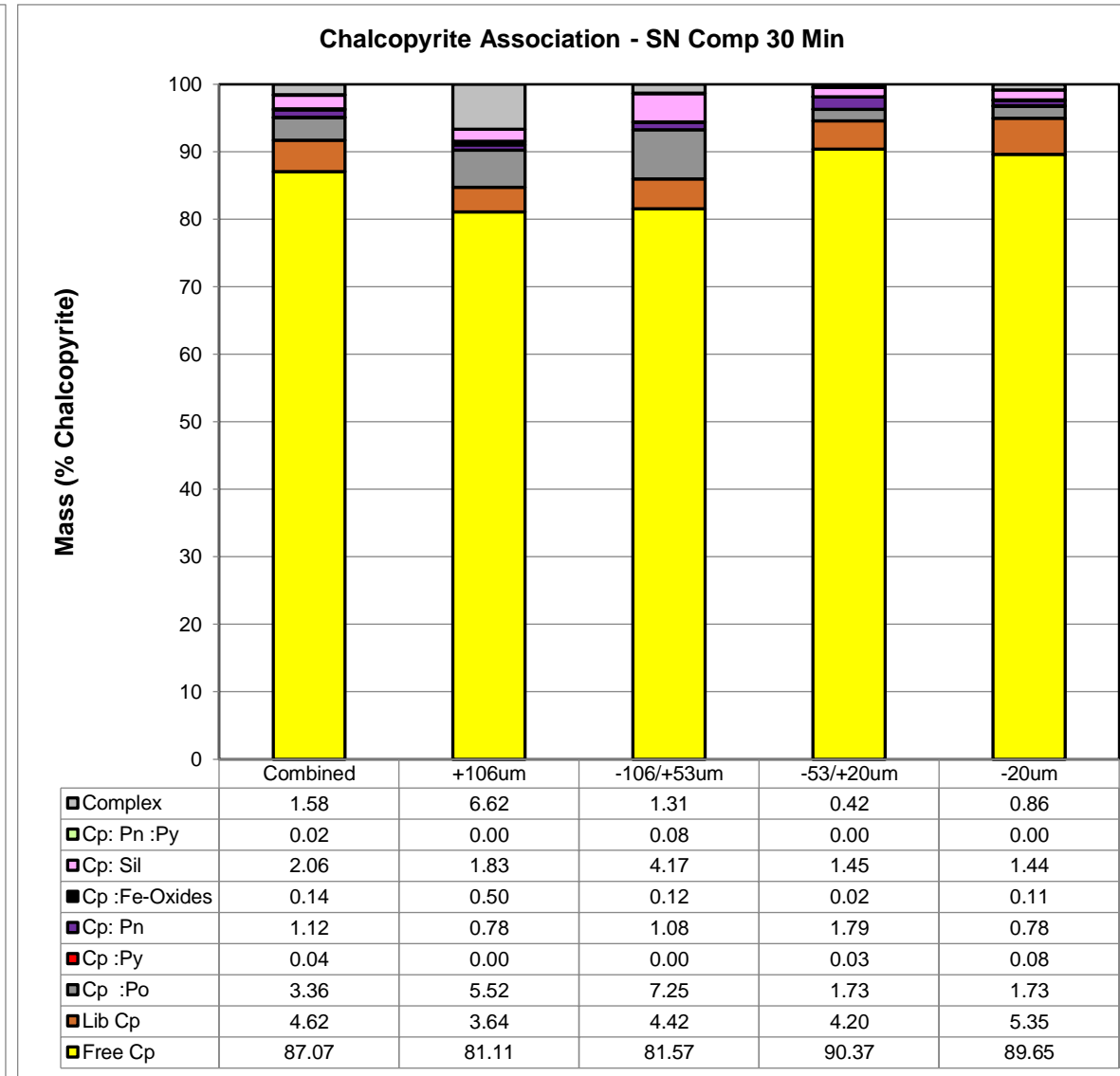
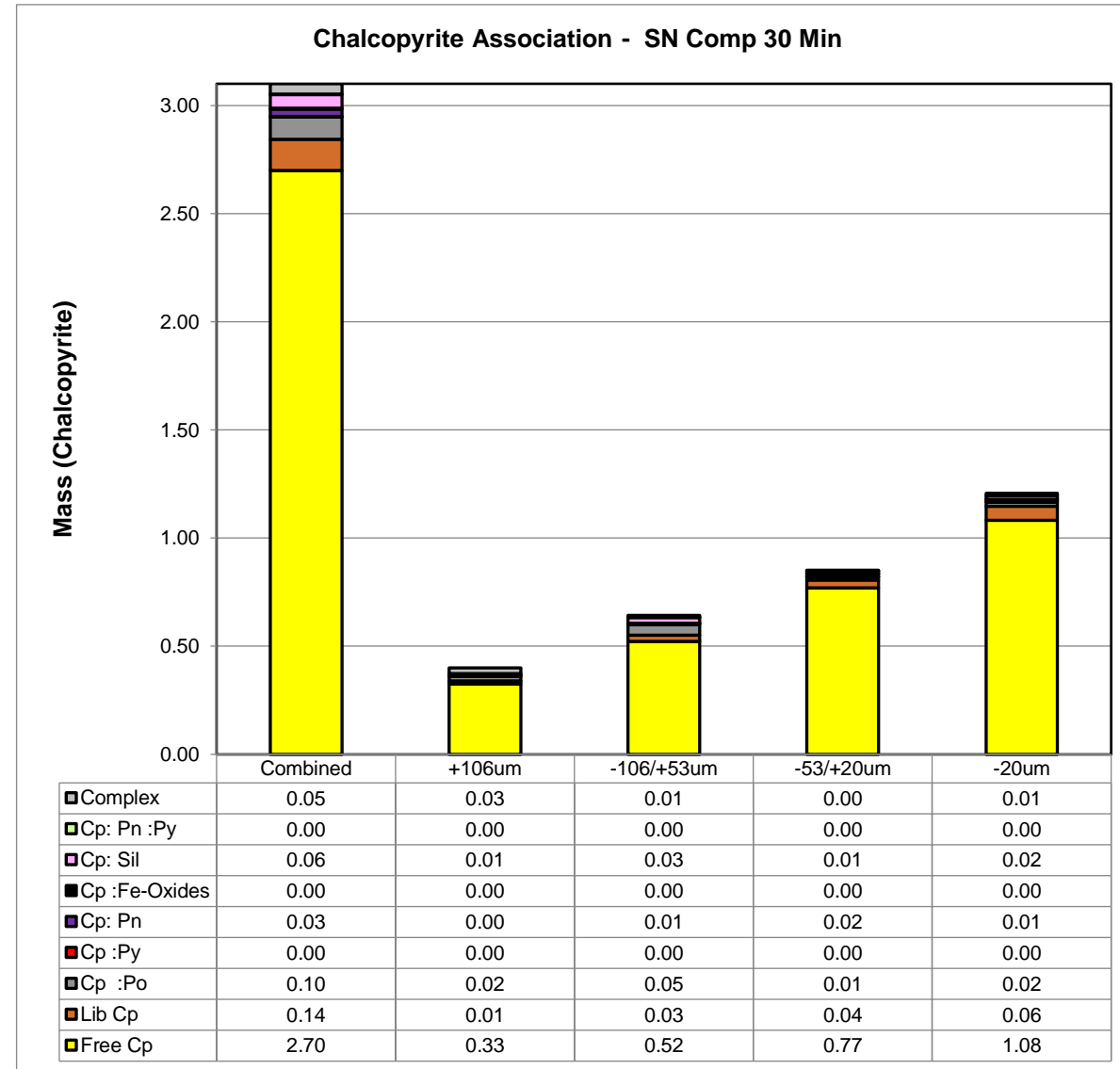

Absolute Mass of Chalcopyrite Across Fraction

Mineral Name	Combined	+106um	-106/+53um	-53/+20um	-20um
Free Cp	2.70	0.33	0.52	0.77	1.08
Lib Cp	0.14	0.01	0.03	0.04	0.06
Cp :Po	0.10	0.02	0.05	0.01	0.02
Cp :Py	0.00	0.00	0.00	0.00	0.00
Cp: Pn	0.03	0.00	0.01	0.02	0.01
Cp :Fe-Oxides	0.00	0.00	0.00	0.00	0.00
Cp: Sil	0.06	0.01	0.03	0.01	0.02
Cp: Pn :Py	0.00	0.00	0.00	0.00	0.00
Complex	0.05	0.03	0.01	0.00	0.01
Total	3.10	0.40	0.64	0.85	1.21
Total (% in fraction)	100.0	12.9	20.7	27.5	38.9

Normalized Mass of Chalcopyrite Across Fraction

Mineral Name	Combined	+106um	-106/+53um	-53/+20um	-20um
Free Cp	87.07	81.11	81.57	90.37	89.65
Lib Cp	4.62	3.64	4.42	4.20	5.35
Cp :Po	3.36	5.52	7.25	1.73	1.73
Cp :Py	0.04	0.00	0.00	0.03	0.08
Cp: Pn	1.12	0.78	1.08	1.79	0.78
Cp :Fe-Oxides	0.14	0.50	0.12	0.02	0.11
Cp: Sil	2.06	1.83	4.17	1.45	1.44
Cp: Pn :Py	0.02	0.00	0.08	0.00	0.00
Complex	1.58	6.62	1.31	0.42	0.86
Total	100.0	100.0	100.0	100.0	100.0
Liberated	87.07408896	81.11426127	81.57195984	90.37000945	89.6539388

North American Nickel
18559-01
M15046-JUN21

High Definition Mineralogical Analysis using

Image Grid - Pyrrhotite Association

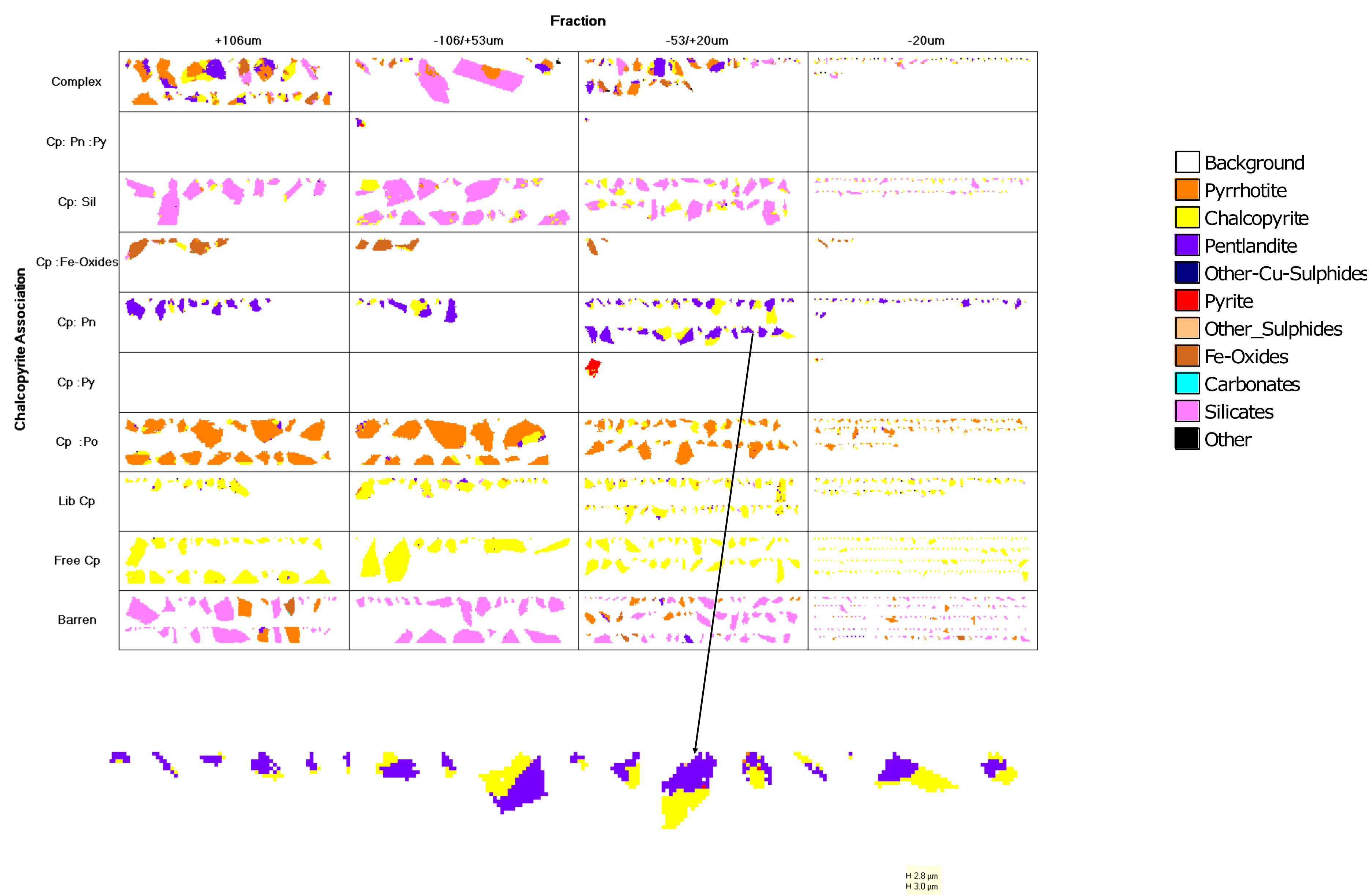

North American Nickel
 18559-01
 MI5046-JUN21

High Definition Mineralogical Analysis using QEMSCAN (Quantitative Evaluation of Materials by Scanning Electron Microscopy)

Silicates Liberation

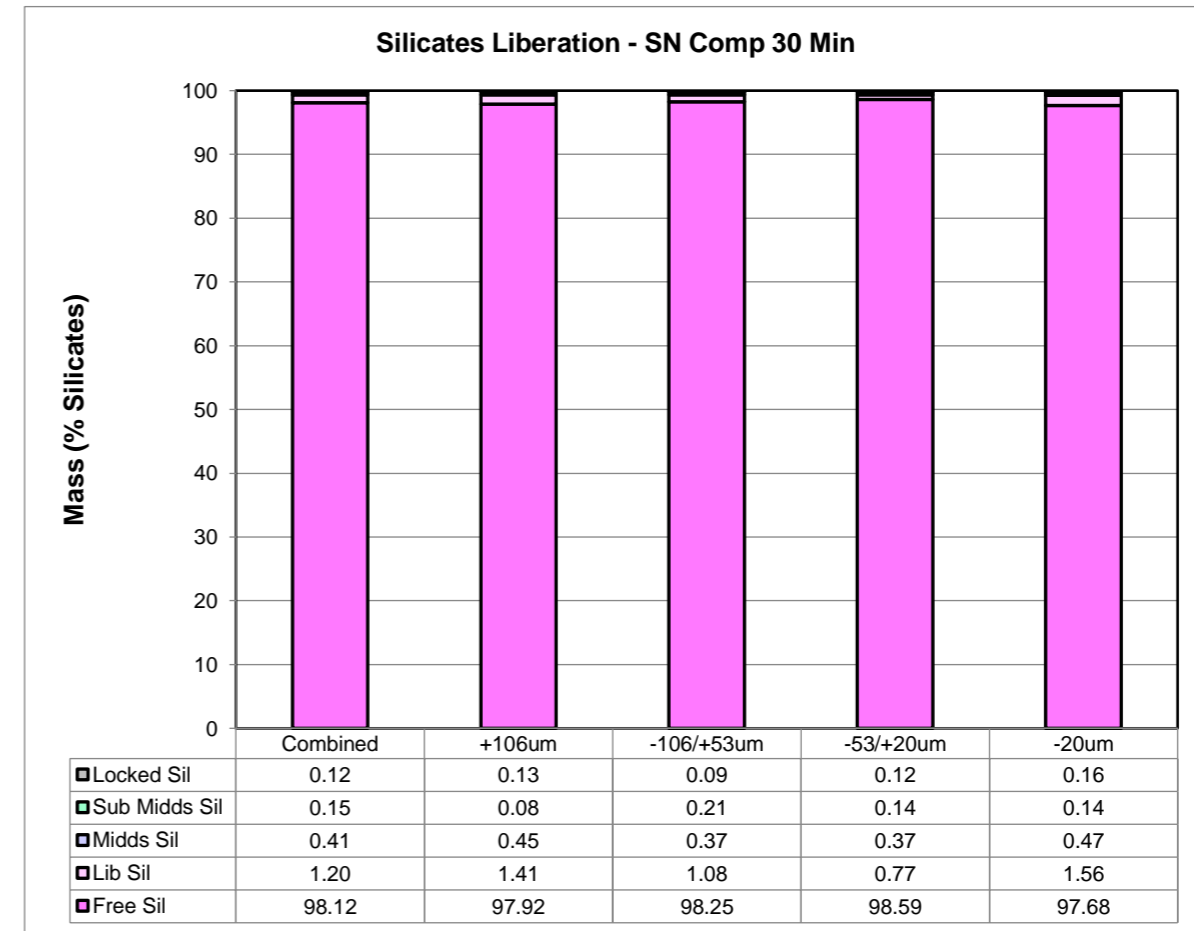
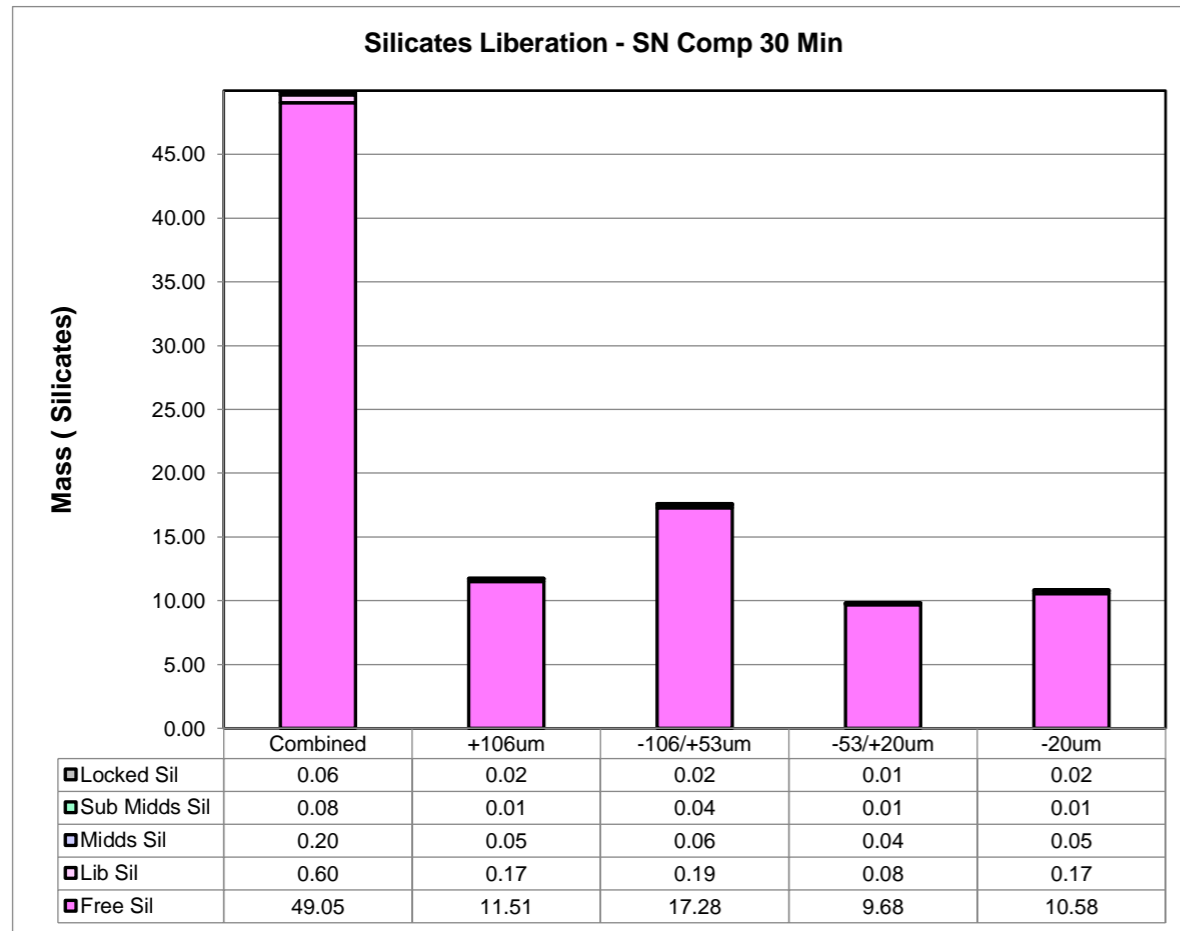

Absolute Mass of Silicates Across Fraction

Mineral Name	Combined	+106um	-106/+53um	-53/+20um	-20um
Free Sil	49.05	11.51	17.28	9.68	10.58
Lib Sil	0.60	0.17	0.19	0.08	0.17
Midds Sil	0.20	0.05	0.06	0.04	0.05
Sub Midds Sil	0.08	0.01	0.04	0.01	0.01
Locked Sil	0.06	0.02	0.02	0.01	0.02
Total	49.99	11.76	17.58	9.82	10.83
Total (% in fraction)	100.0	23.5	35.2	19.6	21.7

Normalized Mass of Silicates Across Fraction

Mineral Name	Combined	+106um	-106/+53um	-53/+20um	-20um
Free Sil	98.12	97.92	98.25	98.59	97.68
Lib Sil	1.20	1.41	1.08	0.77	1.56
Midds Sil	0.41	0.45	0.37	0.37	0.47
Sub Midds Sil	0.15	0.08	0.21	0.14	0.14
Locked Sil	0.12	0.13	0.09	0.12	0.16
Total	100.0	100.0	100.0	100.0	100.0

North American Nickel
 18559-01
 MI5046-JUN21

High Definition Mineralogical Analysis using QEMSCAN (Quantitative Evaluation of Materials by Scanning Electron Microscopy)

Silicates Association

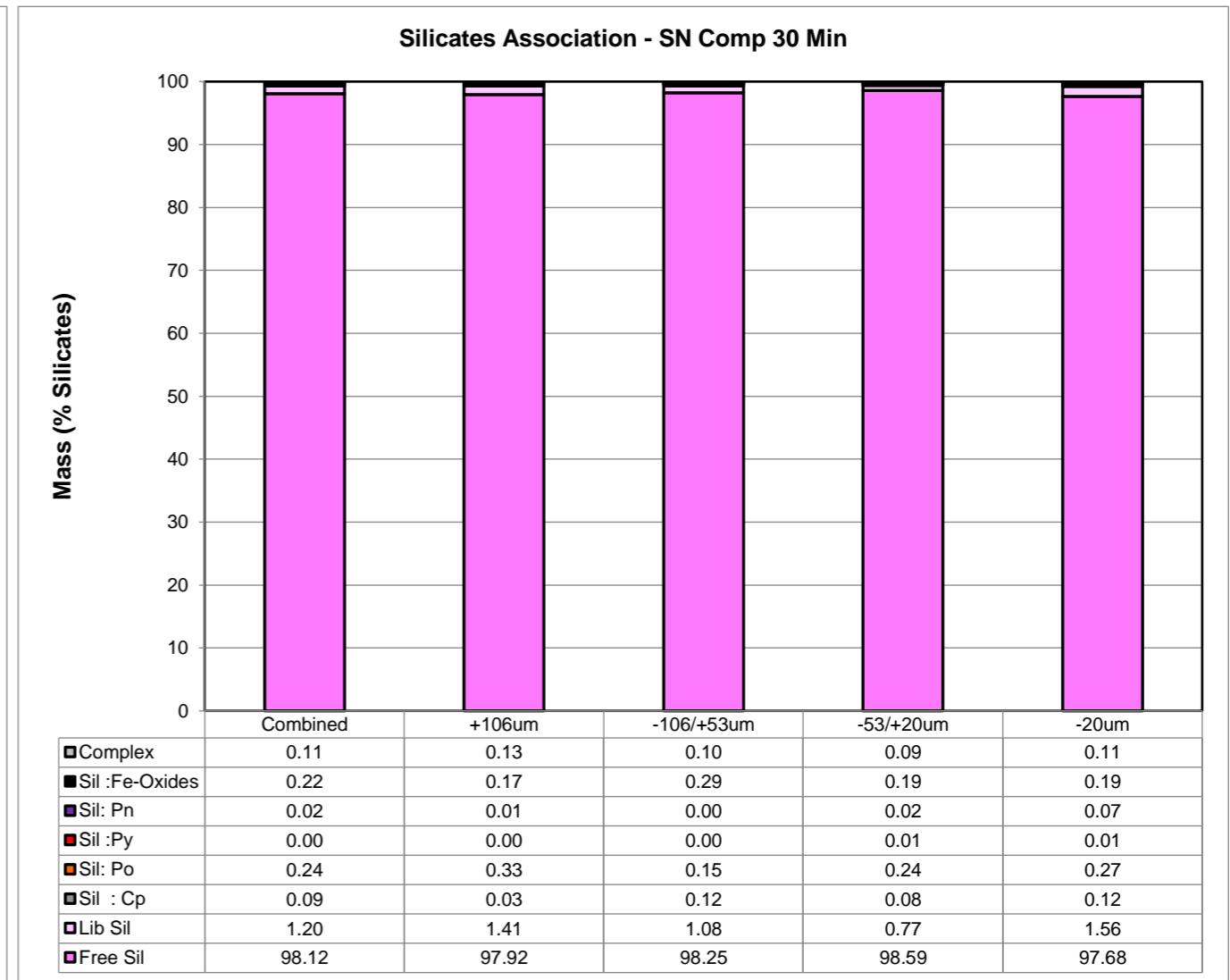
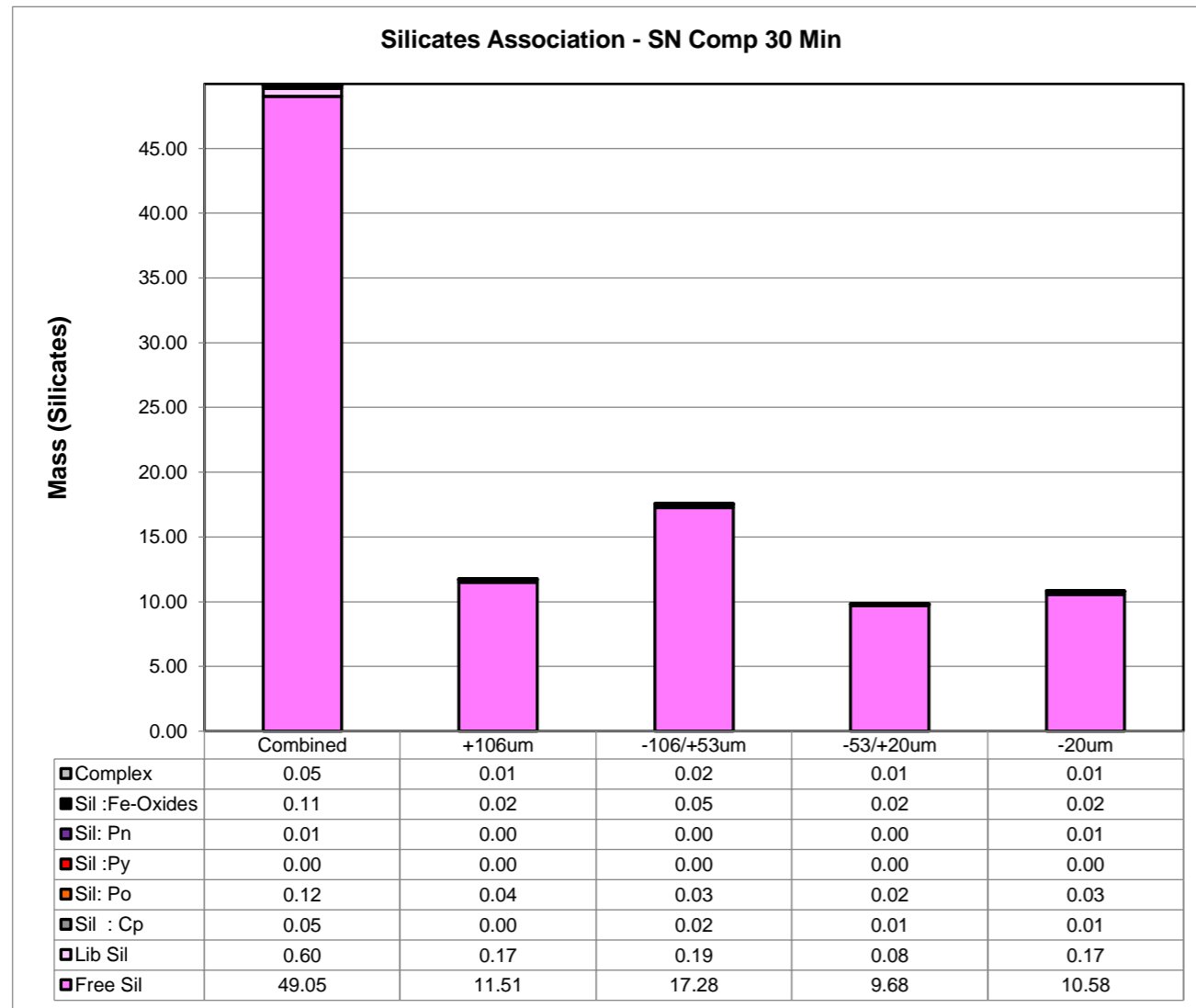

Absolute Mass of Silicates Across Fraction

Mineral Name	Combined	+106um	-106/+53um	-53/+20um	-20um
Free Sil	49.05	11.51	17.28	9.68	10.58
Lib Sil	0.60	0.17	0.19	0.08	0.17
Sil : Cp	0.05	0.00	0.02	0.01	0.01
Sil: Po	0.12	0.04	0.03	0.02	0.03
Sil :Py	0.00	0.00	0.00	0.00	0.00
Sil: Pn	0.01	0.00	0.00	0.00	0.01
Sil :Fe-Oxides	0.11	0.02	0.05	0.02	0.02
Complex	0.05	0.01	0.02	0.01	0.01
Total	49.99	11.76	17.58	9.82	10.83
Total (% in fraction)	100.0	23.5	35.2	19.6	21.7

Normalized Mass of Silicates Across Fraction

Mineral Name	Combined	+106um	-106/+53um	-53/+20um	-20um
Free Sil	98.12	97.92	98.25	98.59	97.68
Lib Sil	1.20	1.41	1.08	0.77	1.56
Sil : Cp	0.09	0.03	0.12	0.08	0.12
Sil: Po	0.24	0.33	0.15	0.24	0.27
Sil :Py	0.00	0.00	0.00	0.01	0.01
Sil: Pn	0.02	0.01	0.00	0.02	0.07
Sil :Fe-Oxides	0.22	0.17	0.29	0.19	0.19
Complex	0.11	0.13	0.10	0.09	0.11
Total	100.0	100.0	100.0	100.0	100.0
Liberated	99.3183327	99.33643318	99.33167266	99.36137106	99.23798243

North American Nickel
 18559-01
 MI5046-JUN21

High Definition Mineralogical Analysis using QEMSCAN (Quantitative Evaluation of Materials by Scanning Electron Microscopy)

Mineral Release Curves

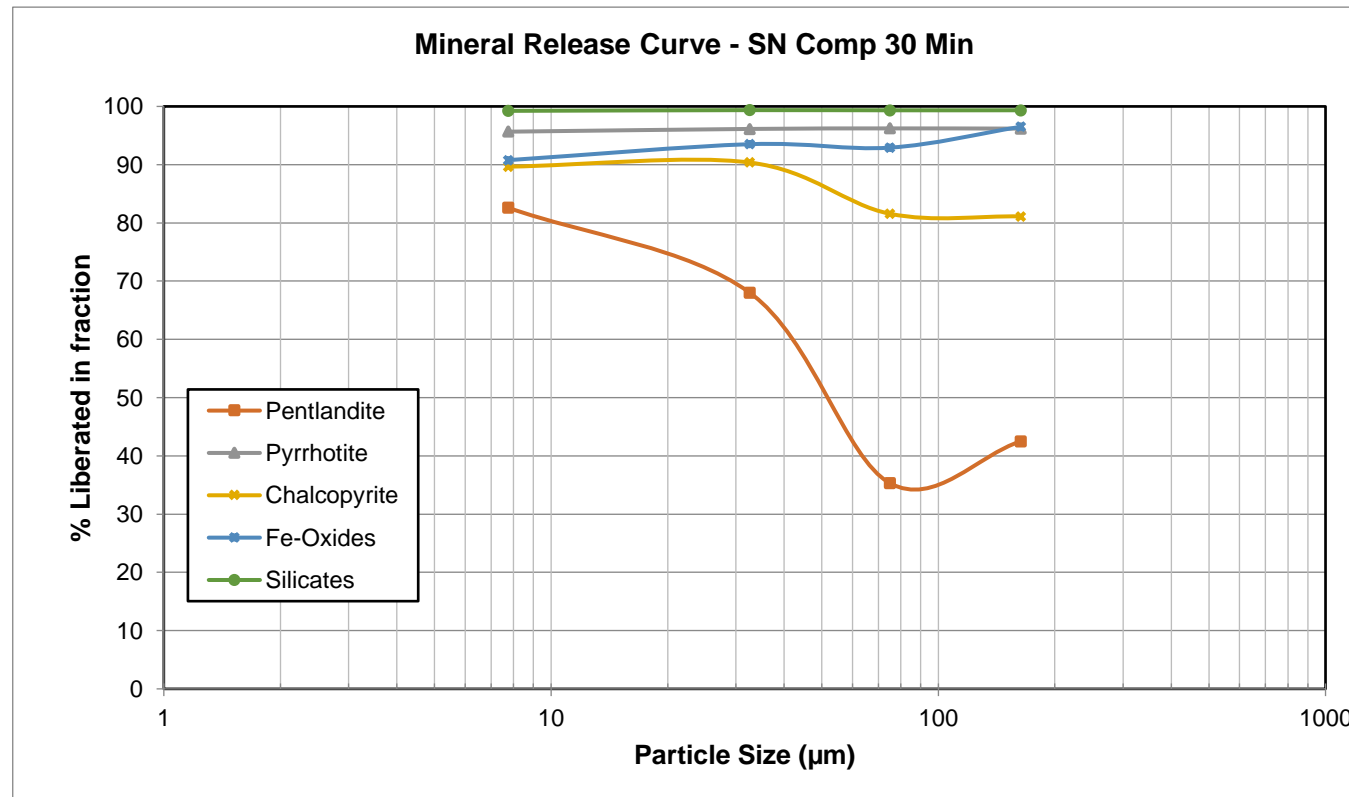

Sample				
Fraction				
Average Particle Size (µm)	163.44	74.95	32.56	7.75
Mineral Mass % 80% Lib				
Pentlandite	42.51	35.33	68.04	82.61
Pyrrhotite	96.19	96.23	96.13	95.66
Chalcopyrite	81.11	81.57	90.37	89.65
Fe-Oxides	96.51	92.93	93.51	90.77
Silicates	99.34	99.33	99.36	99.24

North American Nickel
18559-01
MI5046-JUN21

High Definition Mineralogical Analysis using QEMSCAN (Quantitative
Evaluation of Materials by Scanning Electron Microscopy)

Cumulative Retained Grain Size Distribution

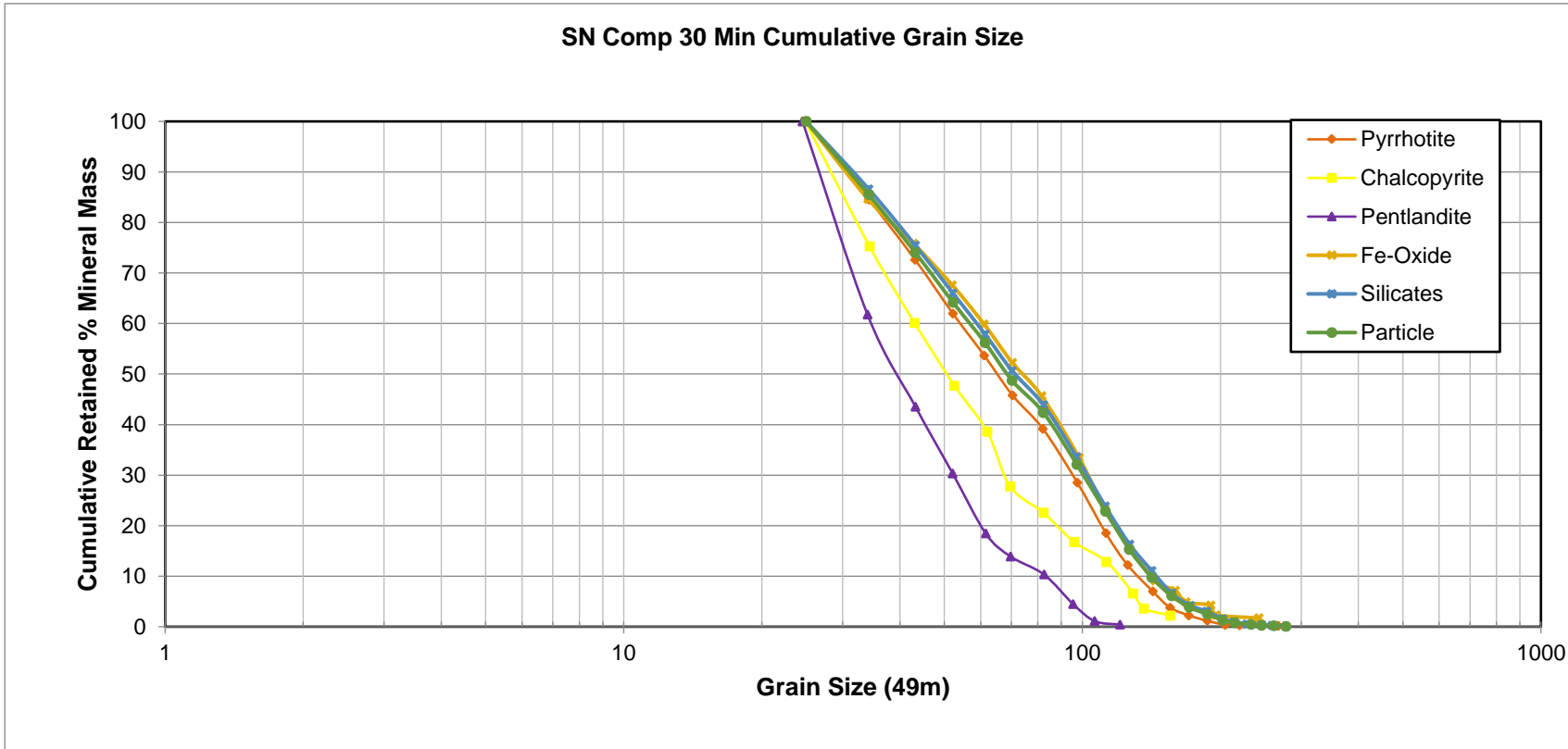

North American Nickel
18559-01
MI5046-JUN21

High Definition Mineralogical Analysis using QEMSCAN (Quantitative Evaluation of Materials by Scanning Electron Microscopy)

Copper Grade vs. Recovery: SN Comp 30 Min

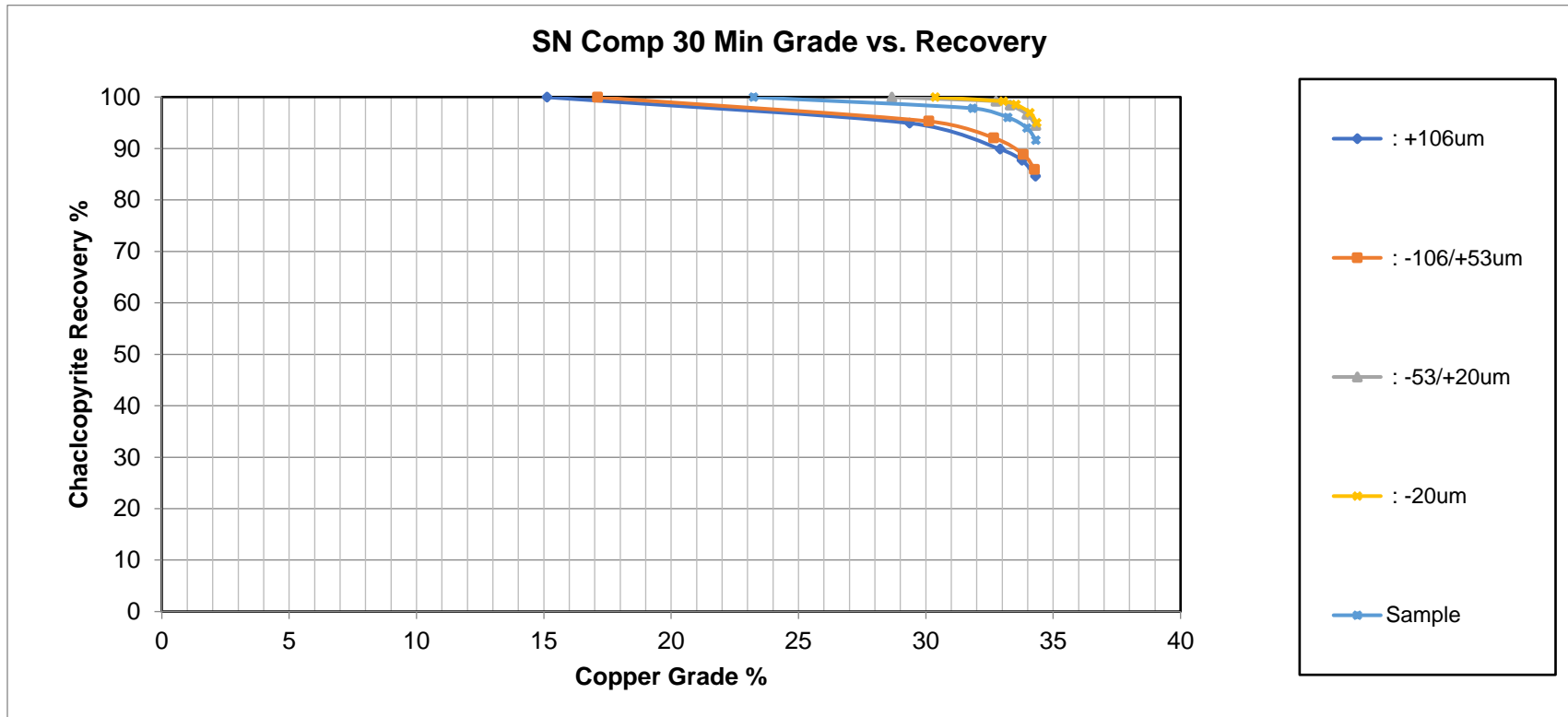

North American Nickel
18559-01
MI5046-JUN21

High Definition Mineralogical Analysis using QEMSCAN (Quantitative Evaluation of Materials by Scanning Electron Microscopy)

Nickle Grade vs. Recovery: SN Comp 30 Min

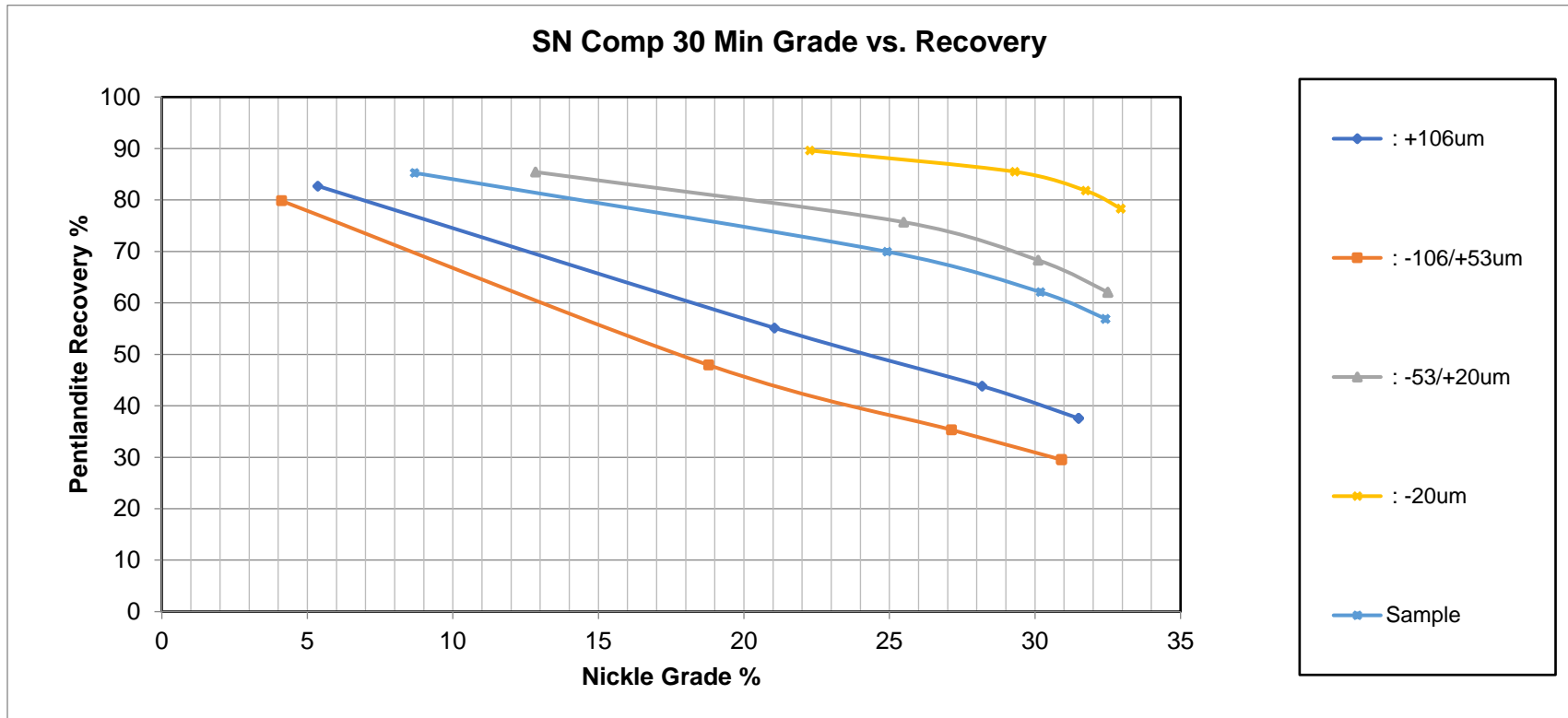



QEMSCAN DATA

prepared for:

North American Nickel

Project 18559-01

MI5046-JUN21

July 15, 2021

Prepared by:



Margot Aldis/Chris Gunning
Mineralogist/Senior Mineralogist

High Definition Mineralogical Analysis using QEMSCAN (Quantitative Evaluation of Materials by Scanning Electron Microscopy) (METH# 8.11.1) used by SGS Minerals Services

SGS Canada

P.O. Box 4300, 185 Concession Street, Lakefield, Ontario, Canada K0L 2H0
Tel. (705) 652-6365 www.sgs.com www.sgs.com/met

Member of the SGS Group (SGS SA)

North American Nickel
18559-01
MI5046-JUN21

High Definition Mineralogical Analysis using QEMSCAN (Quantitative Evaluation of Materials by Scanning Electron Microscopy)

Assay Reconciliation

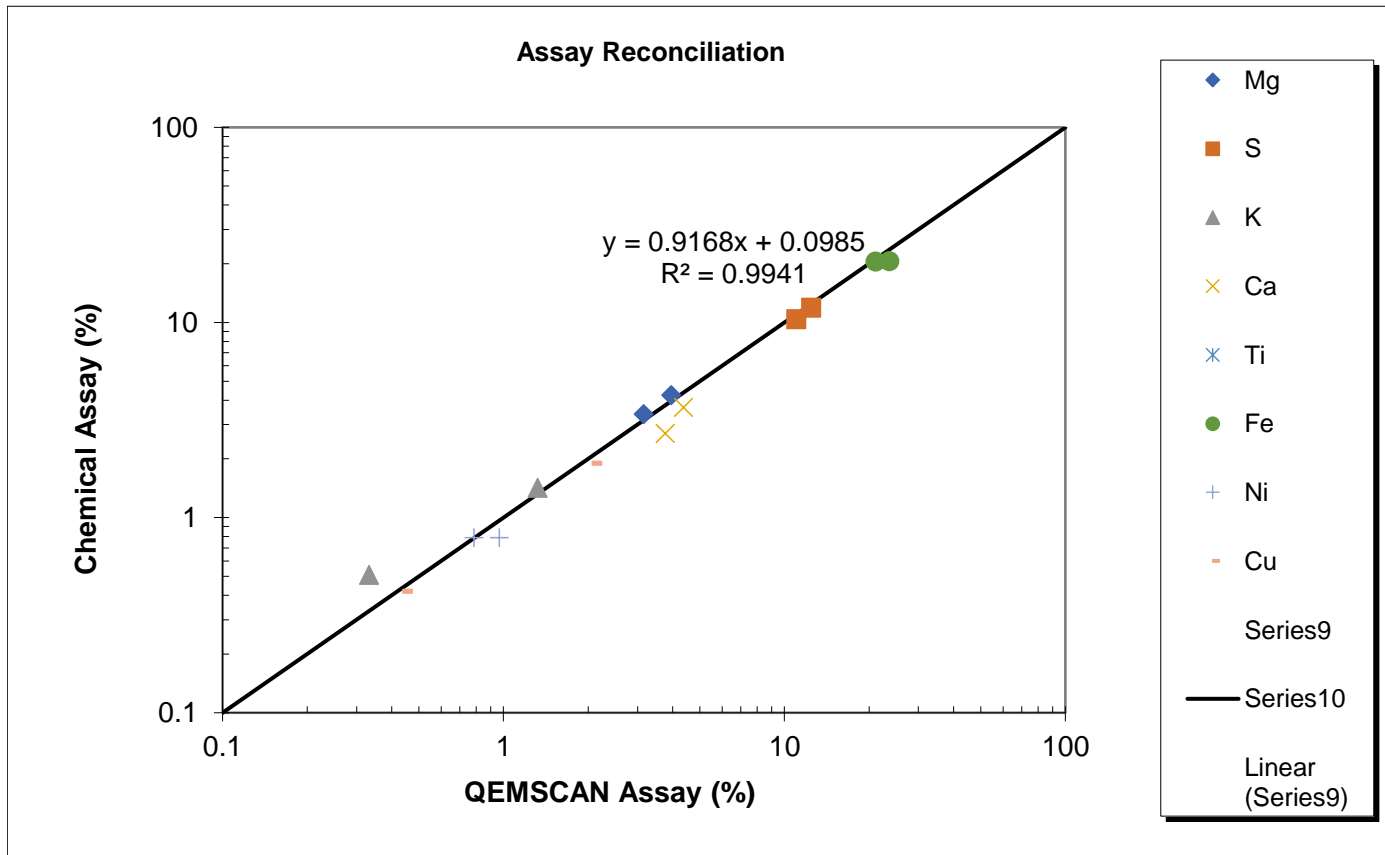

Sample	P Comp 30 Min	S Comp 30 Min
Element	-300/+3um	-300/+3um
Mg (QEMSCAN)	3.15	3.95
Mg (Chemical)	3.39	4.24
S (QEMSCAN)	11.01	12.44
S (Chemical)	10.40	11.90
K (QEMSCAN)	1.32	0.33
K (Chemical)	1.42	0.51
Ca (QEMSCAN)	3.77	4.37
Ca (Chemical)	2.70	3.67
Ti (QEMSCAN)	0.04	0.05
Ti (Chemical)	0.20	0.14
Fe (QEMSCAN)	21.07	23.65
Fe (Chemical)	20.50	20.60
Ni (QEMSCAN)	0.79	0.97
Ni (Chemical)	0.79	0.79
Cu (QEMSCAN)	0.44	2.07
Cu (Chemical)	0.42	1.90

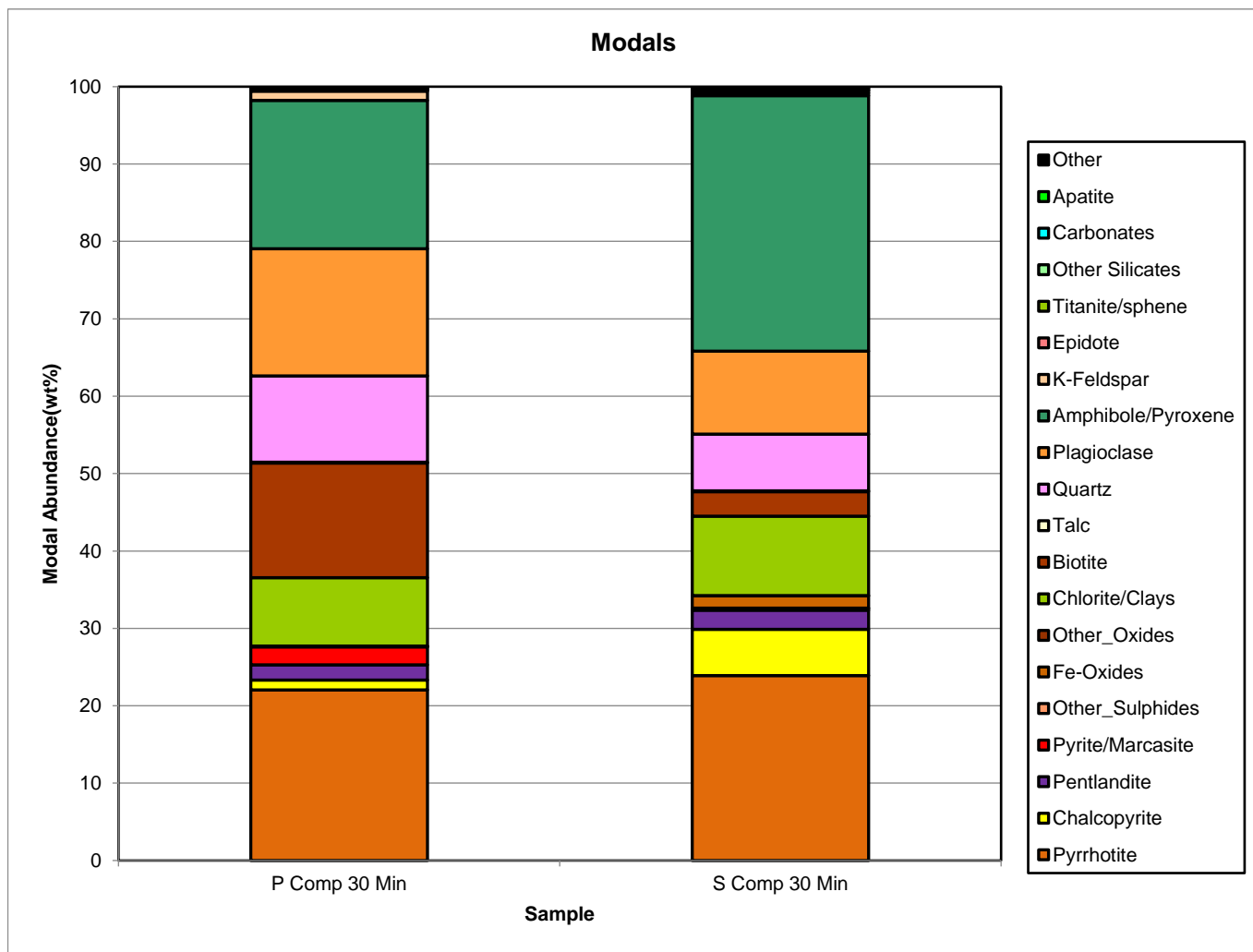

North American Nickel
18559-01
MI5046-JUN21

High Definition Mineralogical Analysis using QEMSCAN (Quantitative Evaluation of Materials by Scanning Electron Microscopy)

Modals

Survey		18559-01 / MI5046-JUN21	
Project		North American Nickel	
Sample		P Comp 30 Min	S Comp 30 Min
Fraction		-300/+3um	-300/+3um
Mass Size Distribution (%)		100.0	100.0
Calculated ESD Particle Size		32	34
		Sample	Sample
Mineral Mass (%)	Pyrrhotite	22.06	23.91
	Chalcopyrite	1.26	5.97
	Pentlandite	1.97	2.47
	Pyrite/Marcasite	2.31	0.22
	Other_Sulphides	0.03	0.04
	Fe-Oxides	0.07	1.59
	Other_Oxides	0.04	0.05
	Chlorite/Clays	8.82	10.26
	Biotite	14.80	3.16
	Talc	0.12	0.13
	Quartz	11.17	7.31
	Plagioclase	16.43	10.74
	Amphibole/Pyroxene	19.14	32.99
	K-Feldspar	1.22	0.38
	Epidote	0.11	0.31
	Titanite/sphene	0.06	0.01
	Other Silicates	0.07	0.19
	Carbonates	0.09	0.13
	Apatite	0.19	0.09
	Other	0.05	0.07
	Total	100.00	100.00
Mean Grain Size by Frequency (µm)	Pyrrhotite	33	34
	Chalcopyrite	25	27
	Pentlandite	17	21
	Pyrite/Marcasite	25	10
	Other_Sulphides	9	9
	Fe-Oxides	12	34
	Other_Oxides	14	27
	Chlorite/Clays	11	17
	Biotite	25	22
	Talc	9	9
	Quartz	27	30
	Plagioclase	29	32
	Amphibole/Pyroxene	29	34
	K-Feldspar	15	16
	Epidote	10	9
	Titanite/sphene	10	10
	Other Silicates	9	13
	Carbonates	25	16
	Apatite	24	17
	Other	11	13

North American Nickel
 18559-01
 MI5046-JUN21

High Definition Mineralogical Analysis using QEMSCAN (Quantitative Evaluation of Materials by Scanning Electron Microscopy)

Cu Department - Absolute

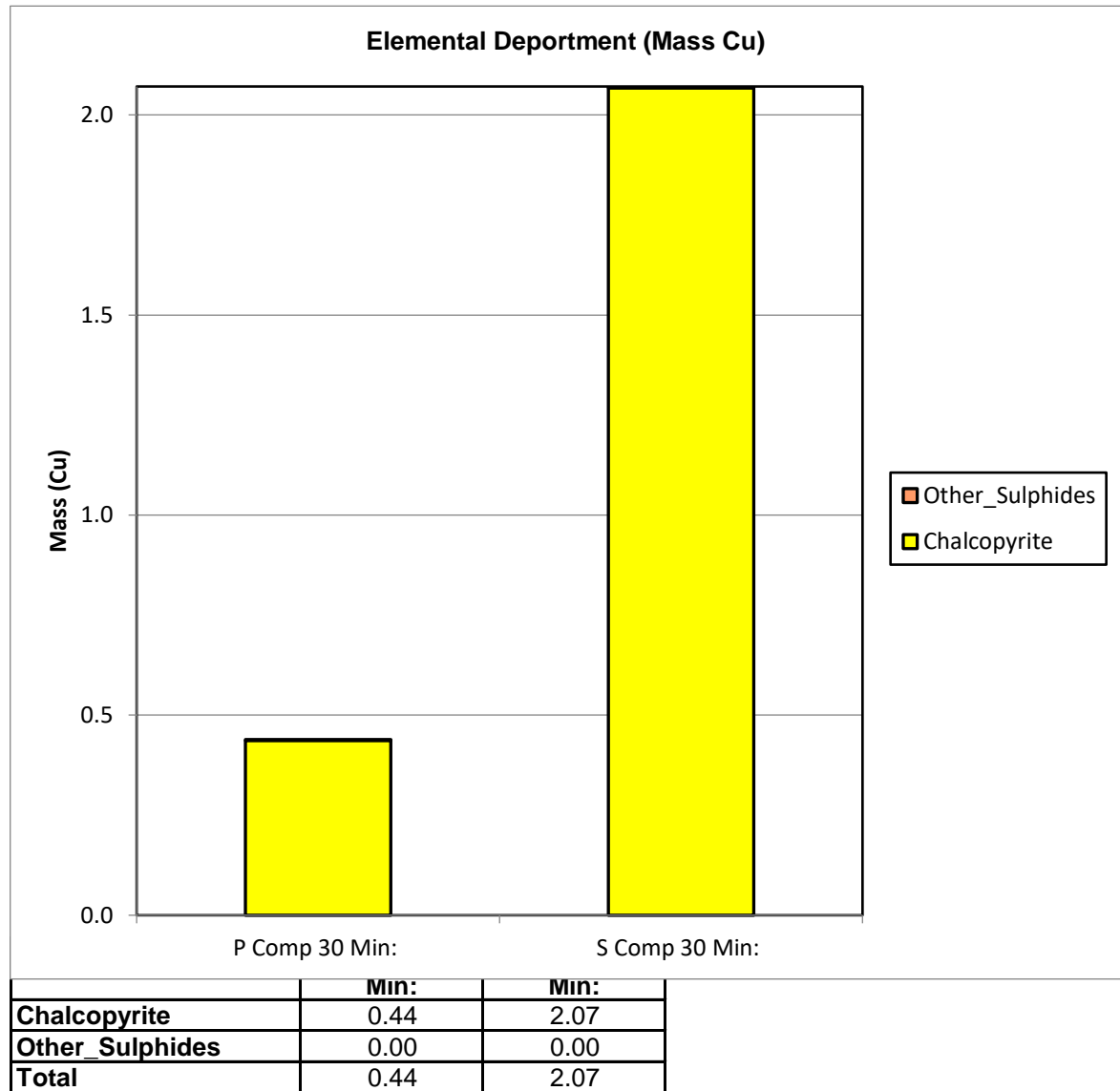

Cu Department - Normalized

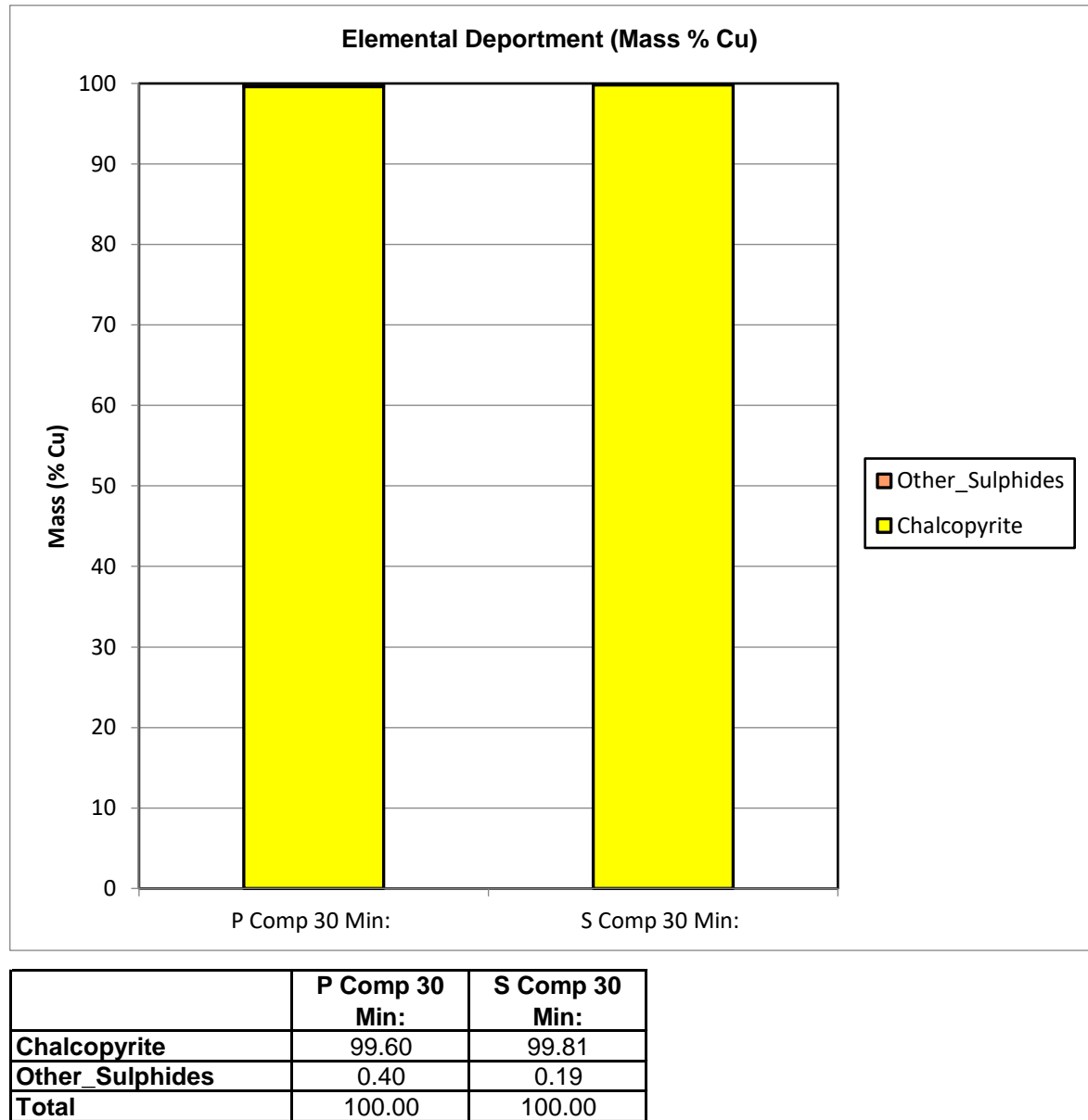

North American Nickel
 18559-01
 MI5046-JUN21

High Definition Mineralogical Analysis using QEMSCAN (Quantitative Evaluation of Materials by Scanning Electron Microscopy)

Ni Department - Absolute

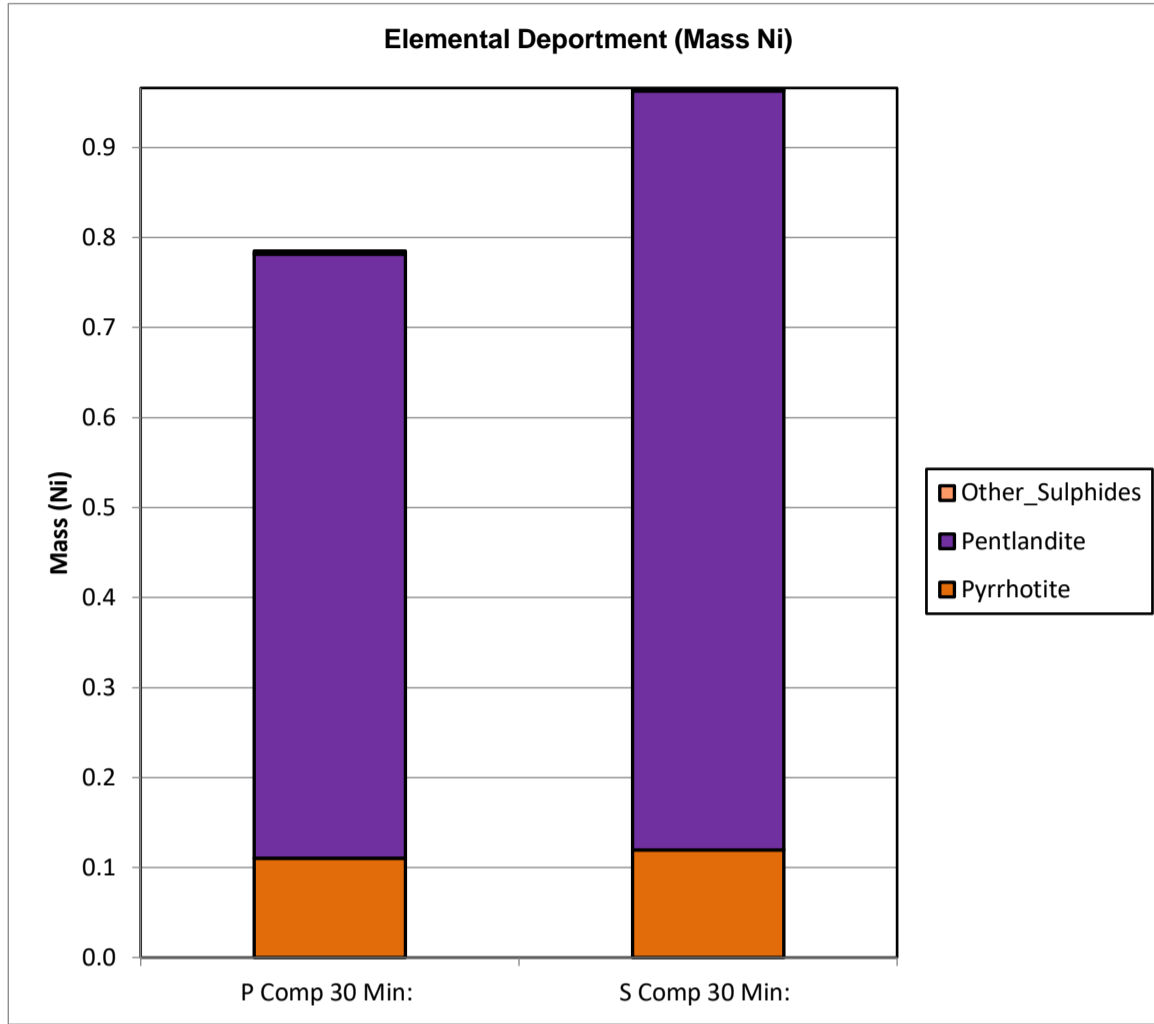

	P Comp 30 Min:	S Comp 30 Min:
Pyrrhotite	0.11	0.12
Pentlandite	0.67	0.84
Other Sulphides	0.00	0.00
Total	0.79	0.97

Ni Department - Normalized

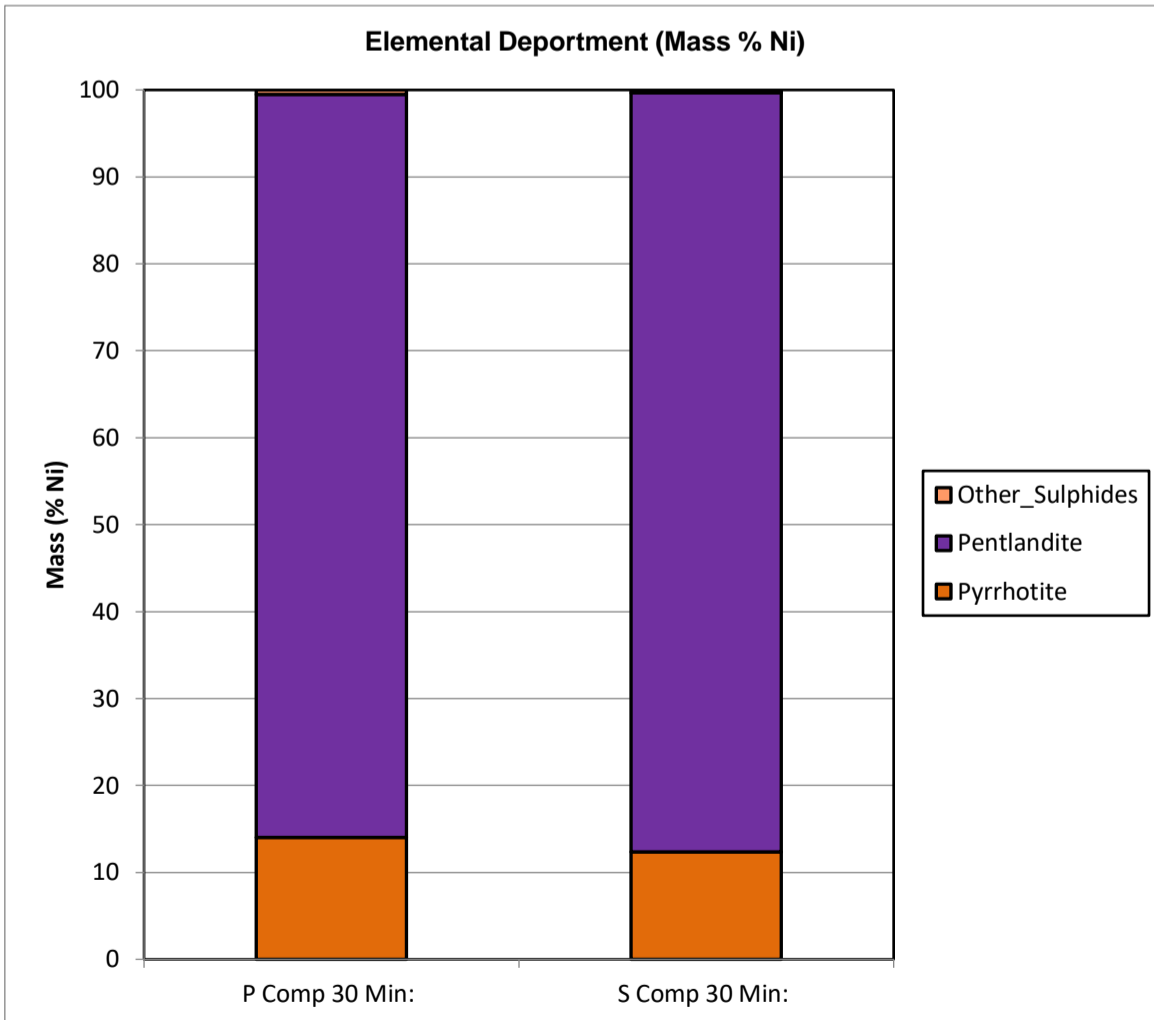

	P Comp 30 Min:	S Comp 30 Min:
Pyrrhotite	14.04	12.37
Pentlandite	85.47	87.29
Other Sulphides	0.49	0.34
Total	100.00	100.00

North American Nickel
18559-01
MI5046-JUN21

High Definition Mineralogical Analysis using QEMSCAN (Quantitative Evaluation of Materials by Scanning Electron Microscopy)

Pentlandite Liberation

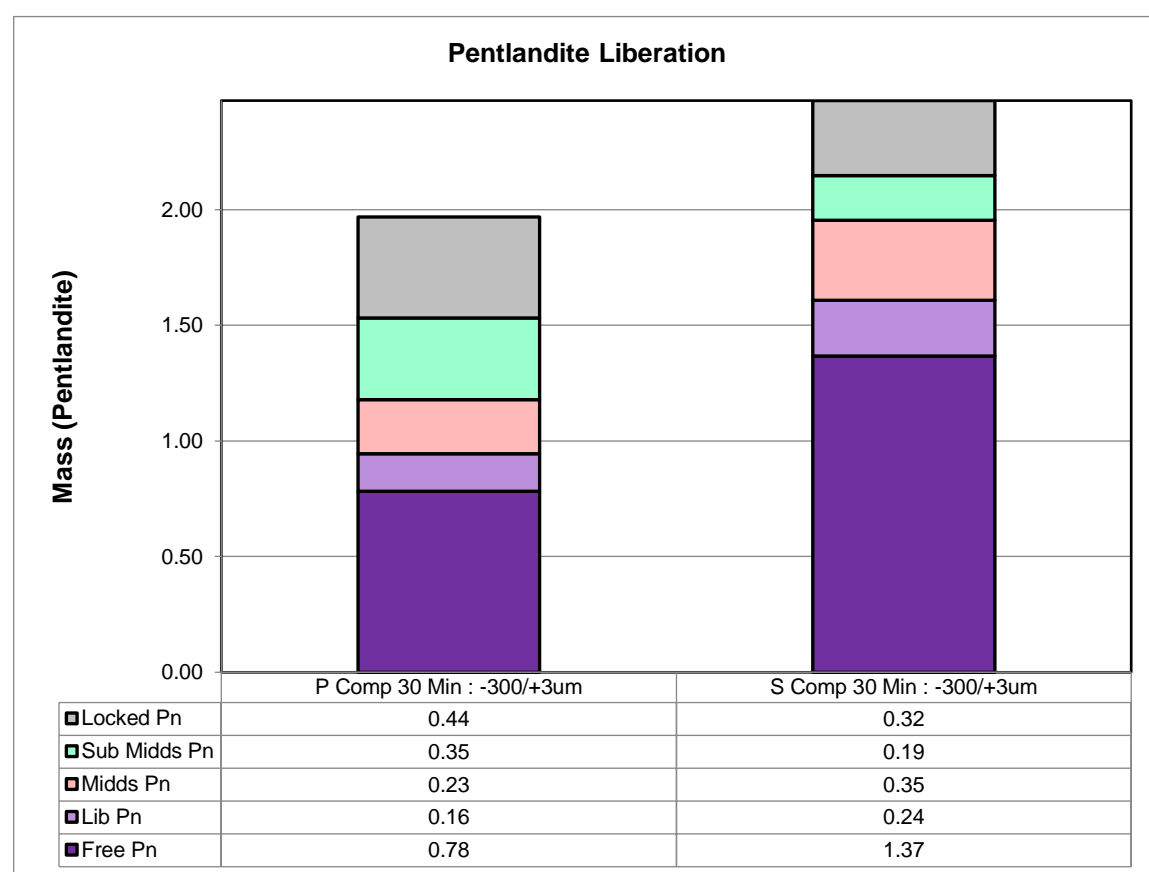

Absolute Mass of Pentlandite Across Samples

Mineral Name	P Comp 30 Min : -300/+3um	S Comp 30 Min : -300/+3um
Free Pn	0.78	1.37
Lib Pn	0.16	0.24
Mids Pn	0.23	0.35
Sub Midds Pn	0.35	0.19
Locked Pn	0.44	0.32
Total	1.97	2.47

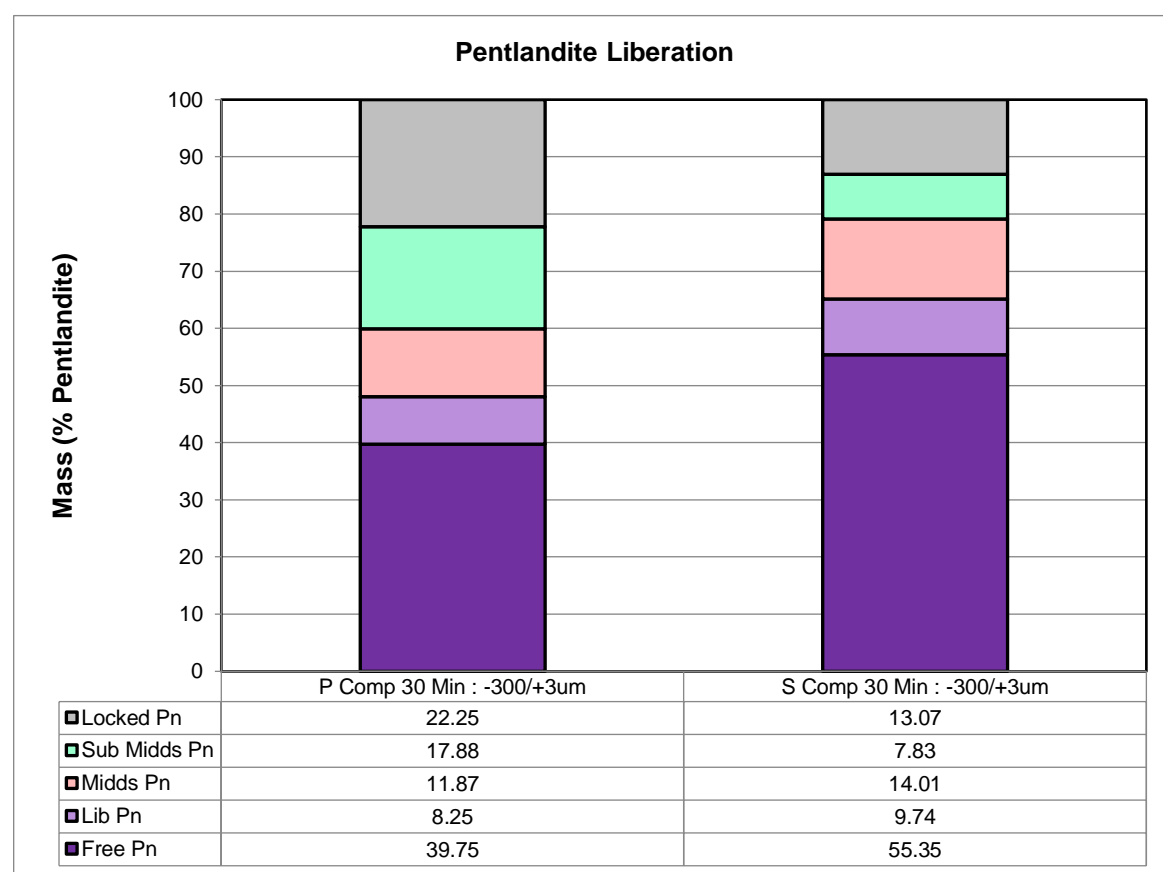

Normalized Mass of Pentlandite Across Samples

Mineral Name	P Comp 30 Min : -300/+3um	S Comp 30 Min : -300/+3um
Free Pn	39.75	55.35
Lib Pn	8.25	9.74
Mids Pn	11.87	14.01
Sub Midds Pn	17.88	7.83
Locked Pn	22.25	13.07
Total	100.00	100.00

North American Nickel
18559-01
MI5046-JUN21

High Definition Mineralogical Analysis using QEMSCAN (Quantitative Evaluation of Materials by Scanning Electron Microscopy)

Pentlandite Association

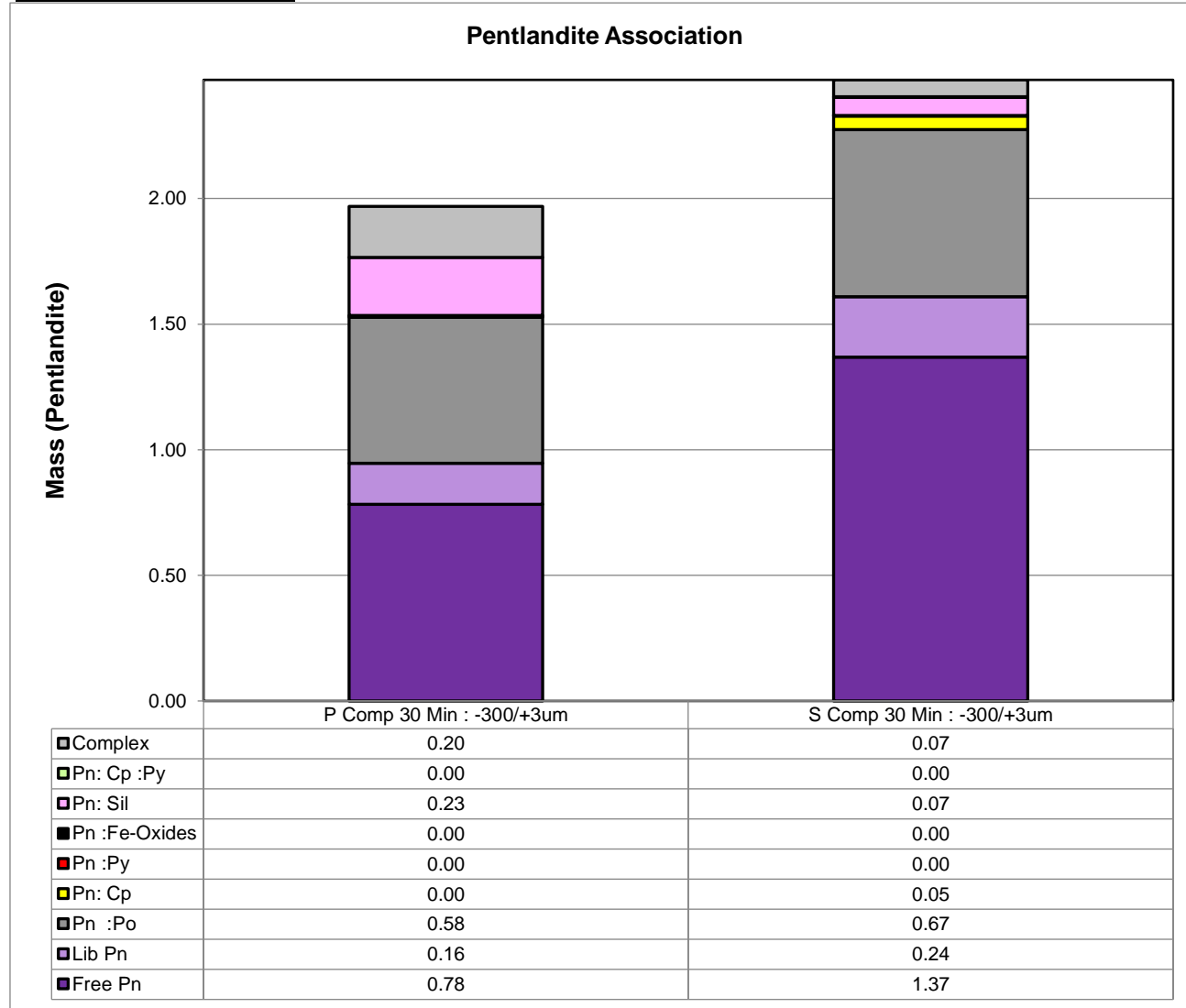

Absolute Mass of Pentlandite Across Samples

Mineral Name	P Comp 30 Min : -300/+3um	S Comp 30 Min : -300/+3um
Free Pn	0.78	1.37
Lib Pn	0.16	0.24
Pn :Po	0.58	0.67
Pn: Cp	0.00	0.05
Pn :Py	0.00	0.00
Pn :Fe-Oxides	0.00	0.00
Pn: Sil	0.23	0.07
Pn: Cp :Py	0.00	0.00
Complex	0.20	0.07
Total	1.97	2.47

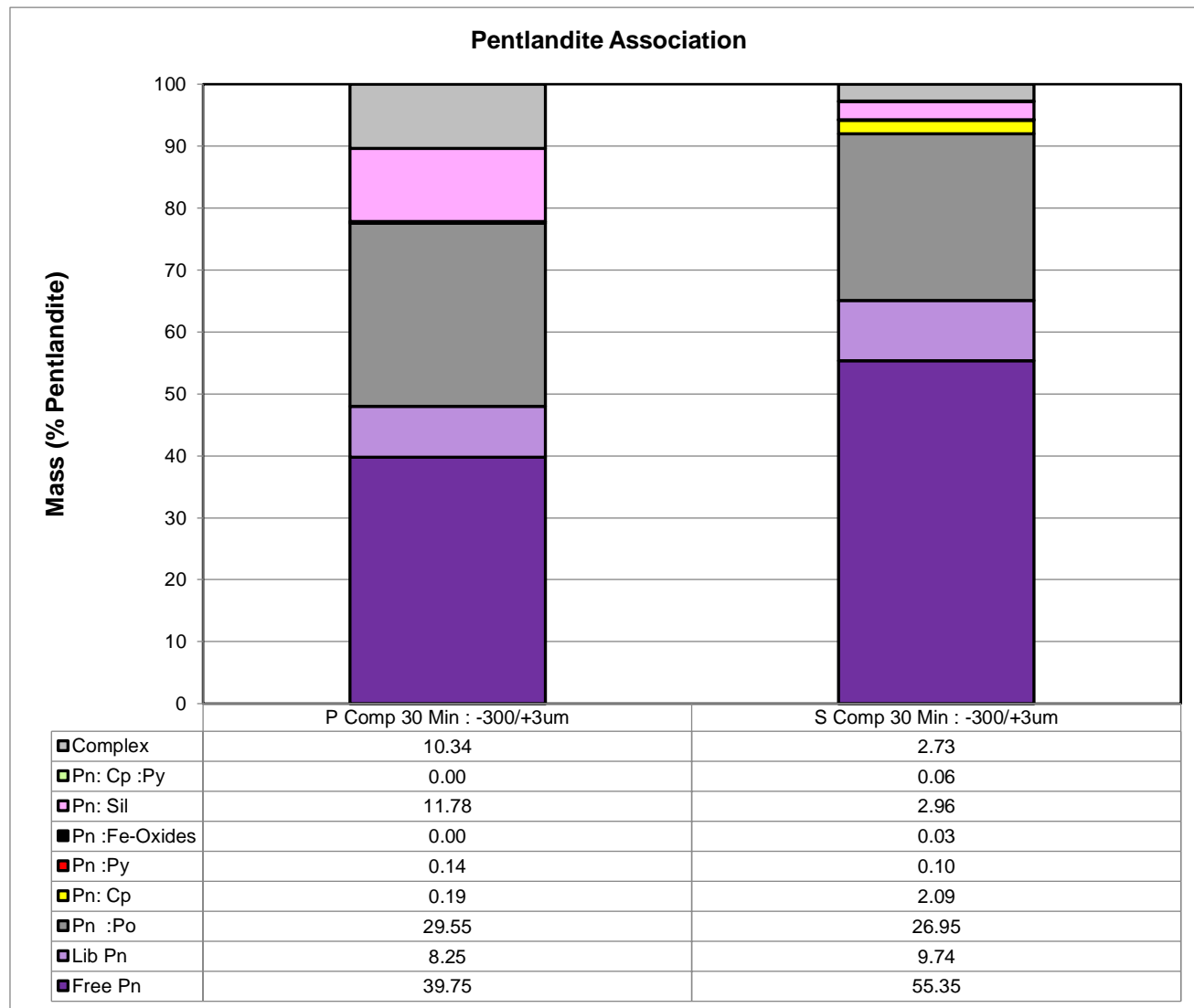

Normalized Mass of Pentlandite Across Samples

Mineral Name	P Comp 30 Min : -300/+3um	S Comp 30 Min : -300/+3um
Free Pn	39.75	55.35
Lib Pn	8.25	9.74
Pn :Po	29.55	26.95
Pn: Cp	0.19	2.09
Pn :Py	0.14	0.10
Pn :Fe-Oxides	0.00	0.03
Pn: Sil	11.78	2.96
Pn: Cp :Py	0.00	0.06
Complex	10.34	2.73
Total	100.00	100.00

North American Nickel
18559-01
M15046-JUN21

High Definition Mineralogical Analysis using

Image Grid - Pentlandite Association

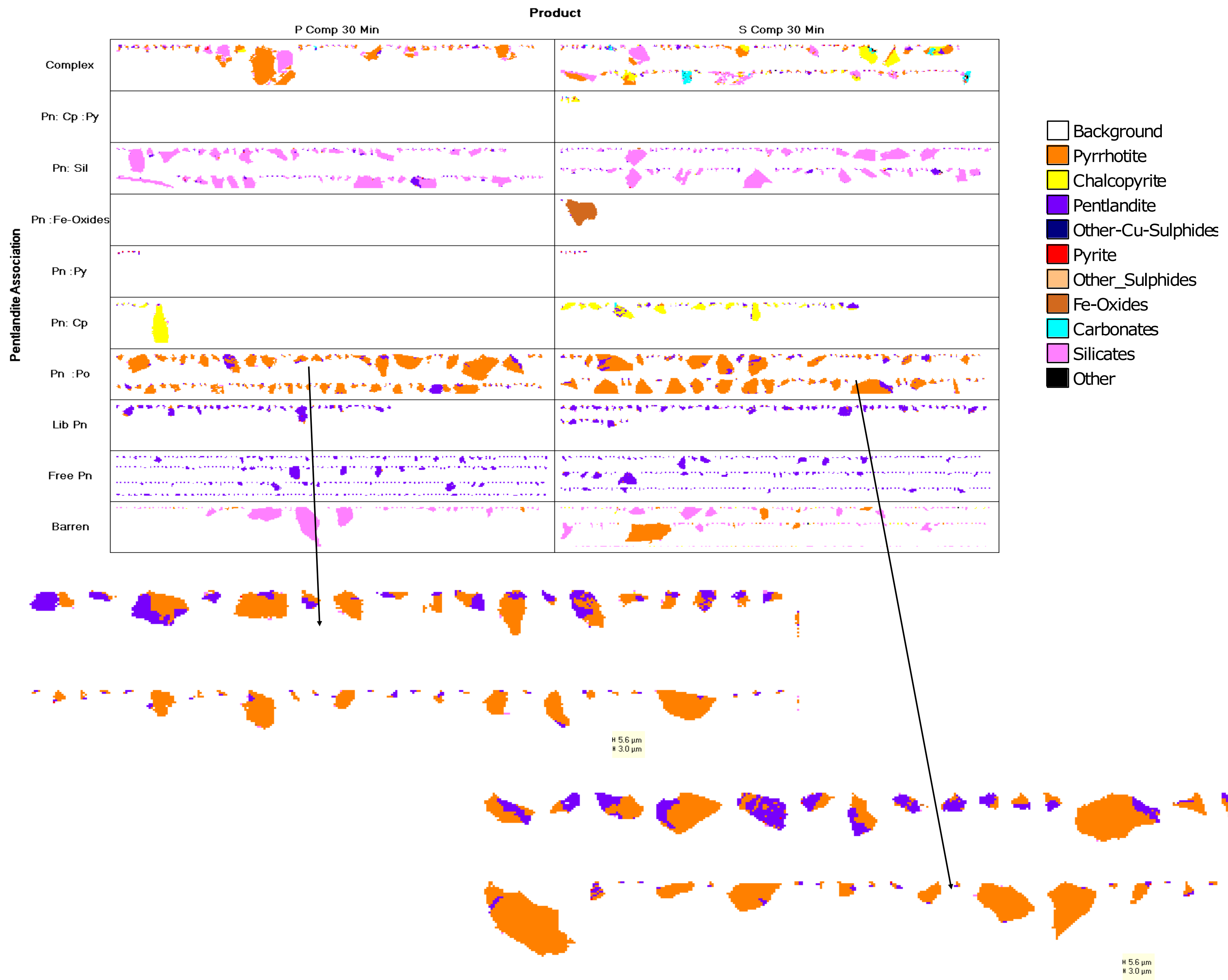

North American Nickel
 18559-01
 MI5046-JUN21

High Definition Mineralogical Analysis using QEMSCAN (Quantitative Evaluation of Materials by Scanning Electron Microscopy)

Pyrrhotite Liberation

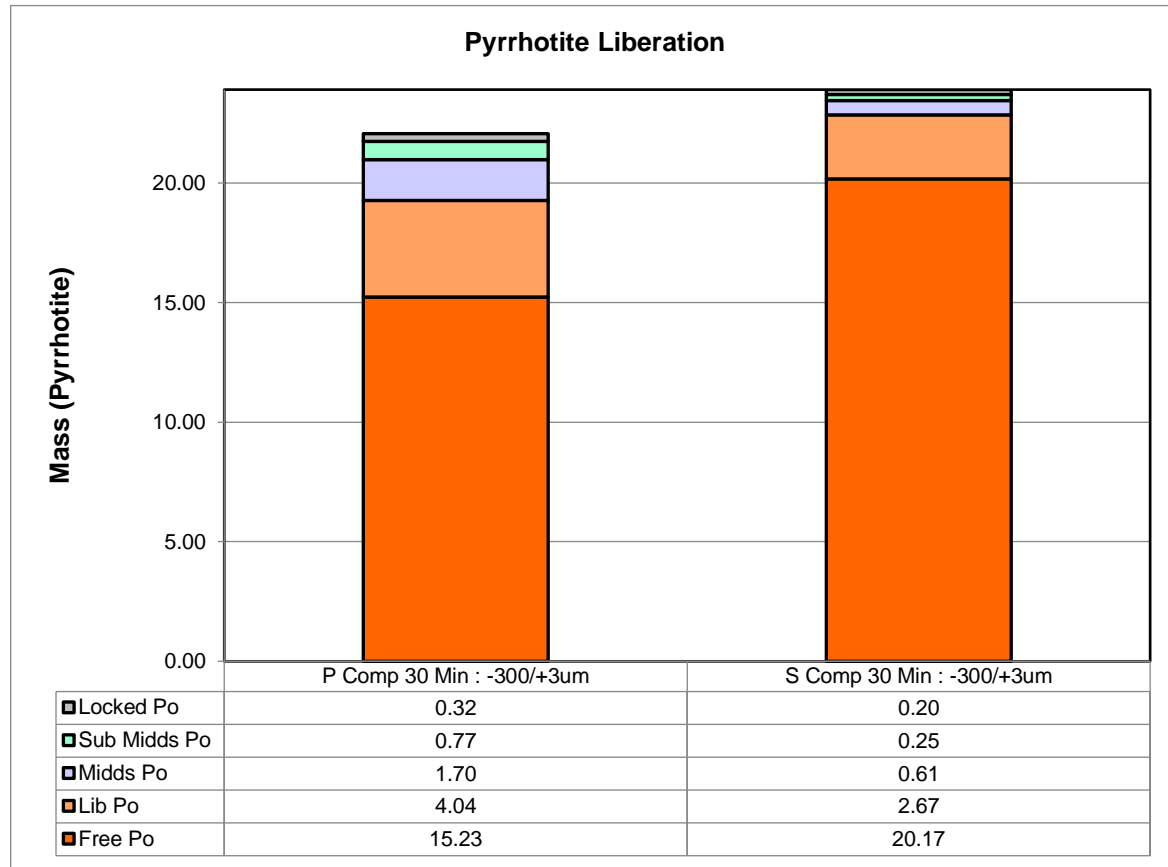

Absolute Mass of Pyrrhotite Across Samples

Mineral Name	P Comp 30 Min : -300/+3um	S Comp 30 Min : -300/+3um
Free Po	15.23	20.17
Lib Po	4.04	2.67
Mids Po	1.70	0.61
Sub Mids Po	0.77	0.25
Locked Po	0.32	0.20
Total	22.06	23.91

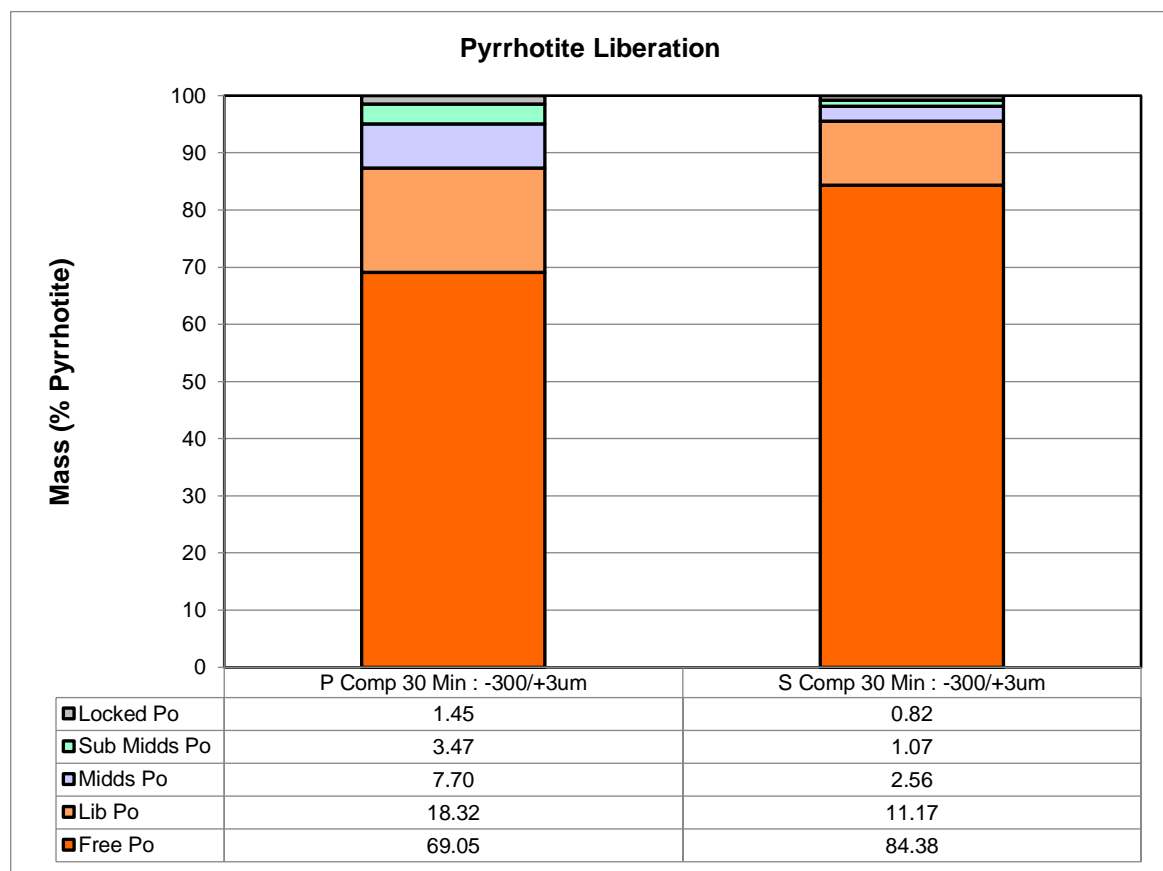

Normalized Mass of Pyrrhotite Across Samples

Mineral Name	P Comp 30 Min : -300/+3um	S Comp 30 Min : -300/+3um
Free Po	69.05	84.38
Lib Po	18.32	11.17
Mids Po	7.70	2.56
Sub Mids Po	3.47	1.07
Locked Po	1.45	0.82
Total	100.00	100.00

North American Nickel
 18559-01
 MI5046-JUN21

High Definition Mineralogical Analysis using QEMSCAN (Quantitative Evaluation of Materials by Scanning Electron Microscopy)

Pyrrhotite Association

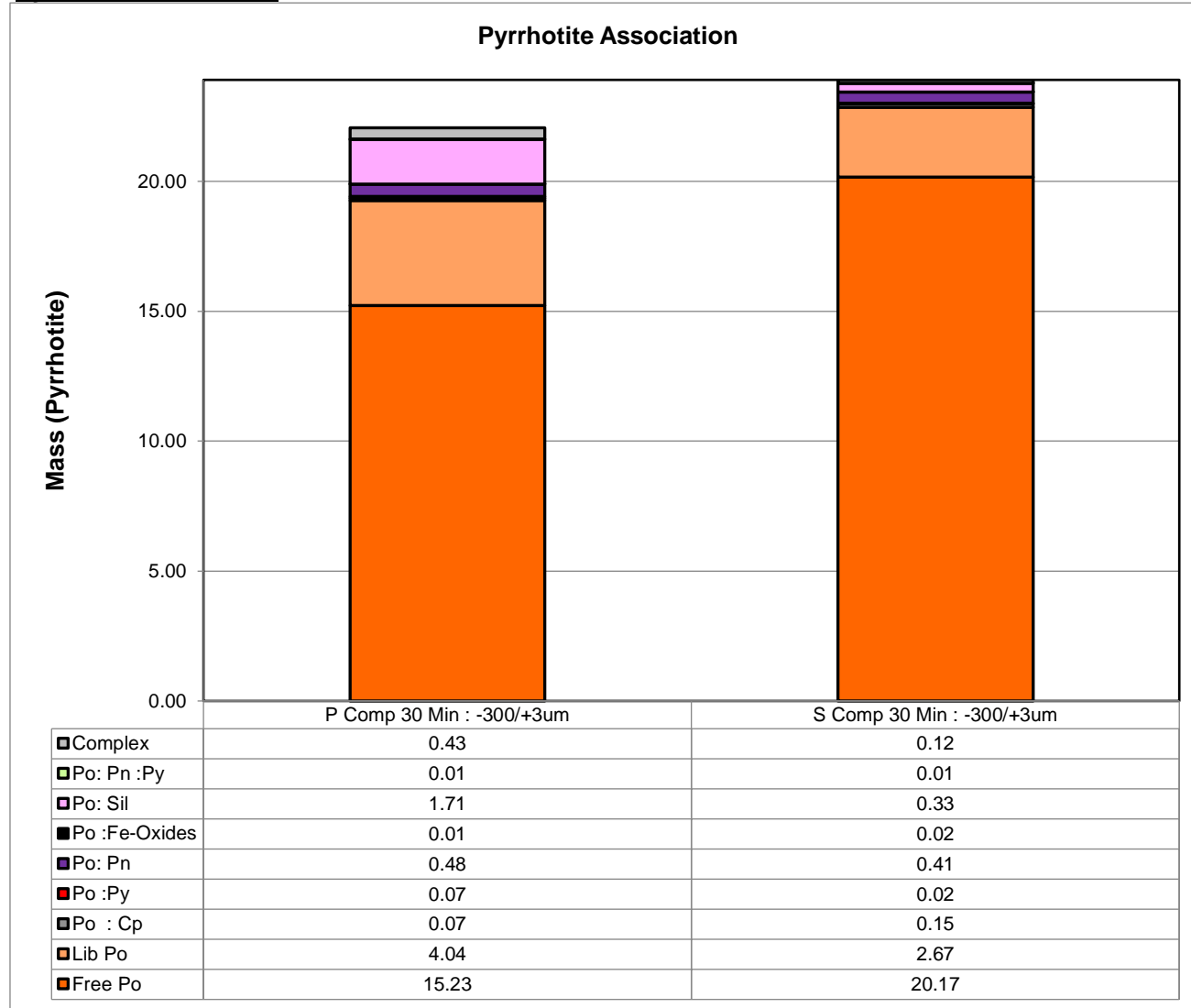

Absolute Mass of Pyrrhotite Across Samples

Mineral Name	P Comp 30 Min : -300/+3um	S Comp 30 Min : -300/+3um
Free Po	15.23	20.17
Lib Po	4.04	2.67
Po : Cp	0.07	0.15
Po :Py	0.07	0.02
Po: Pn	0.48	0.41
Po :Fe-Oxides	0.01	0.02
Po: Sil	1.71	0.33
Po: Pn :Py	0.01	0.01
Complex	0.43	0.12
Total	22.06	23.91

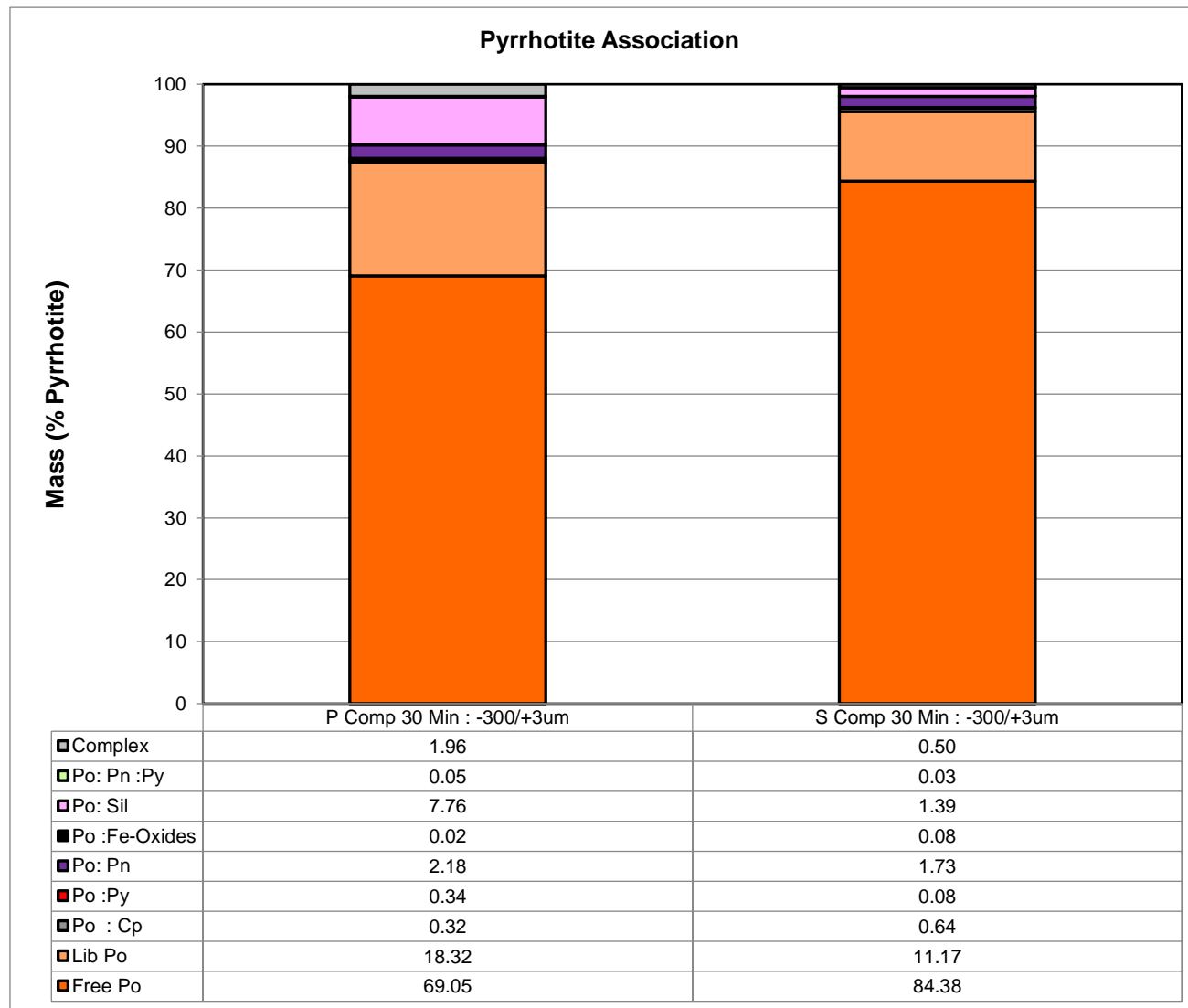

Normalized Mass of Pyrrhotite Across Samples

Mineral Name	P Comp 30 Min : -300/+3um	S Comp 30 Min : -300/+3um
Free Po	69.05	84.38
Lib Po	18.32	11.17
Po : Cp	0.32	0.64
Po :Py	0.34	0.08
Po: Pn	2.18	1.73
Po :Fe-Oxides	0.02	0.08
Po: Sil	7.76	1.39
Po: Pn :Py	0.05	0.03
Complex	1.96	0.50
Total	100.00	100.00

North American Nickel
18559-01
M15046-JUN21

High Definition Mineralogical Analysis using

Image Grid - Pyrrhotite Association

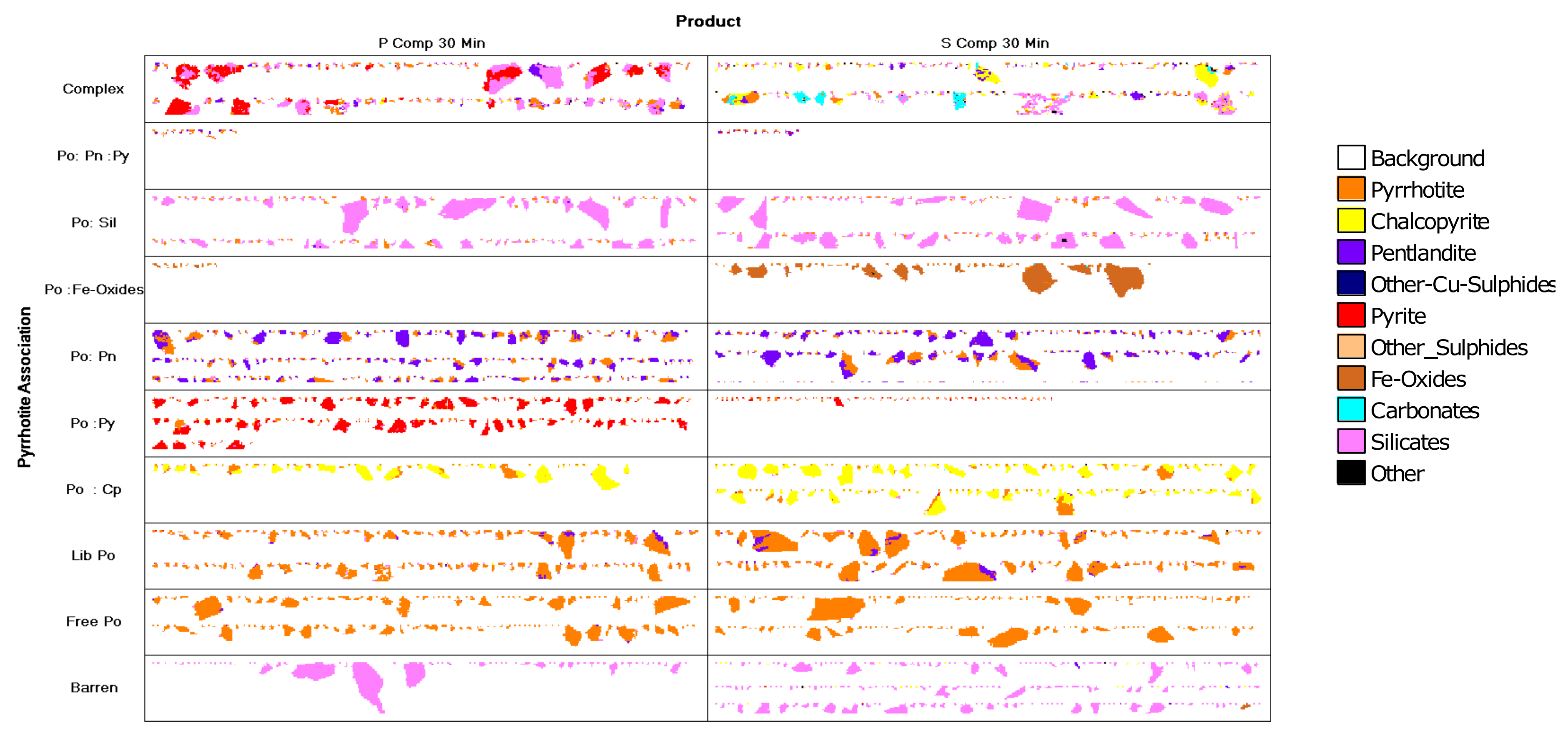

North American Nickel
 18559-01
 MI5046-JUN21

High Definition Mineralogical Analysis using QEMSCAN (Quantitative Evaluation of Materials by Scanning Electron Microscopy)

Chalcopyrite Liberation

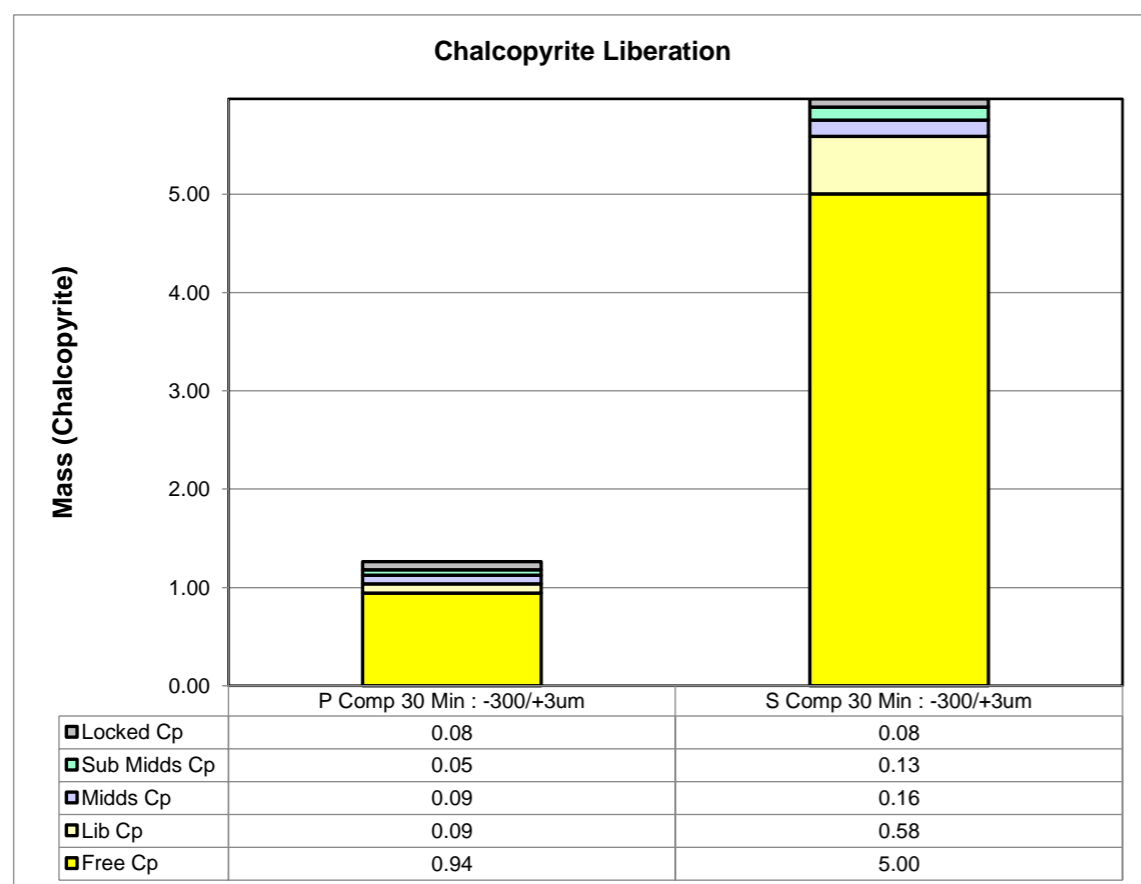

Absolute Mass of Chalcopyrite Across Samples

Mineral Name	P Comp 30 Min : -300/+3um	S Comp 30 Min : -300/+3um
Free Cp	0.94	5.00
Lib Cp	0.09	0.58
Midds Cp	0.09	0.16
Sub Midds Cp	0.05	0.13
Locked Cp	0.08	0.08
Total	1.26	5.97

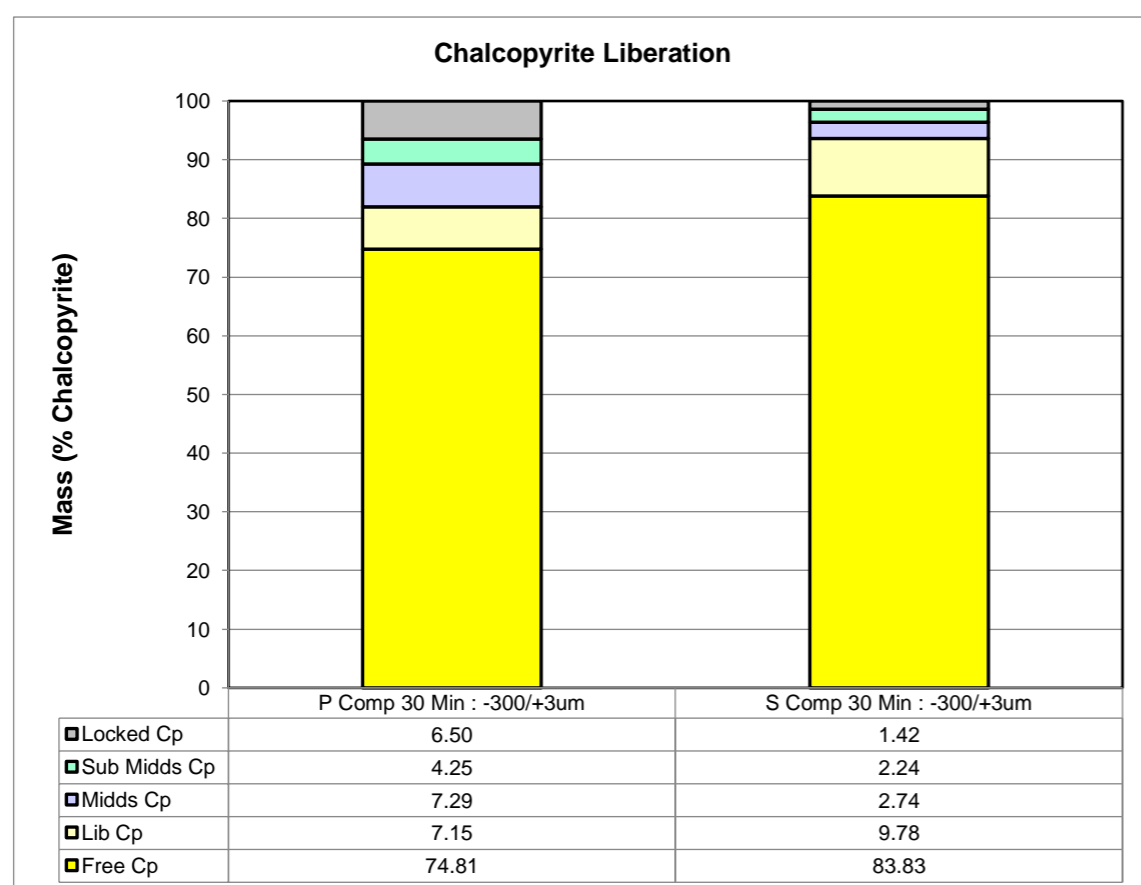

Normalized Mass of Chalcopyrite Across Samples

Mineral Name	P Comp 30 Min : -300/+3um	S Comp 30 Min : -300/+3um
Free Cp	74.81	83.83
Lib Cp	7.15	9.78
Midds Cp	7.29	2.74
Sub Midds Cp	4.25	2.24
Locked Cp	6.50	1.42
Total	100.00	100.00

North American Nickel
18559-01
MI5046-JUN21

High Definition Mineralogical Analysis using QEMSCAN (Quantitative Evaluation of Materials by Scanning Electron Microscopy)

Chalcopyrite Association

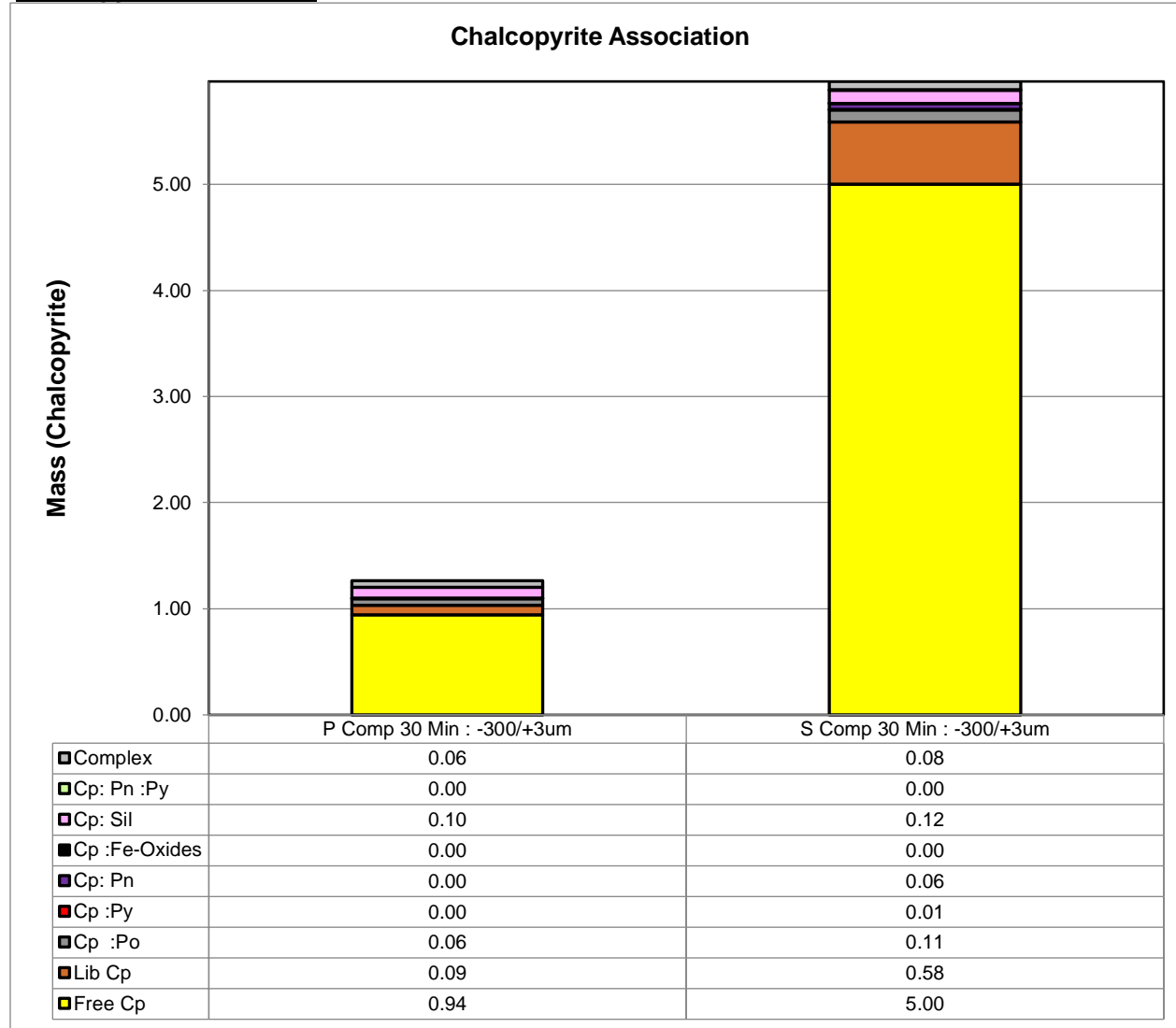

Absolute Mass of Chalcopyrite Across Samples

Mineral Name	P Comp 30 Min : -300/+3um	S Comp 30 Min : -300/+3um
Free Cp	0.94	5.00
Lib Cp	0.09	0.58
Cp :Po	0.06	0.11
Cp :Py	0.00	0.01
Cp: Pn	0.00	0.06
Cp :Fe-Oxides	0.00	0.00
Cp: Sil	0.10	0.12
Cp: Pn :Py	0.00	0.00
Complex	0.06	0.08
Total	1.26	5.97

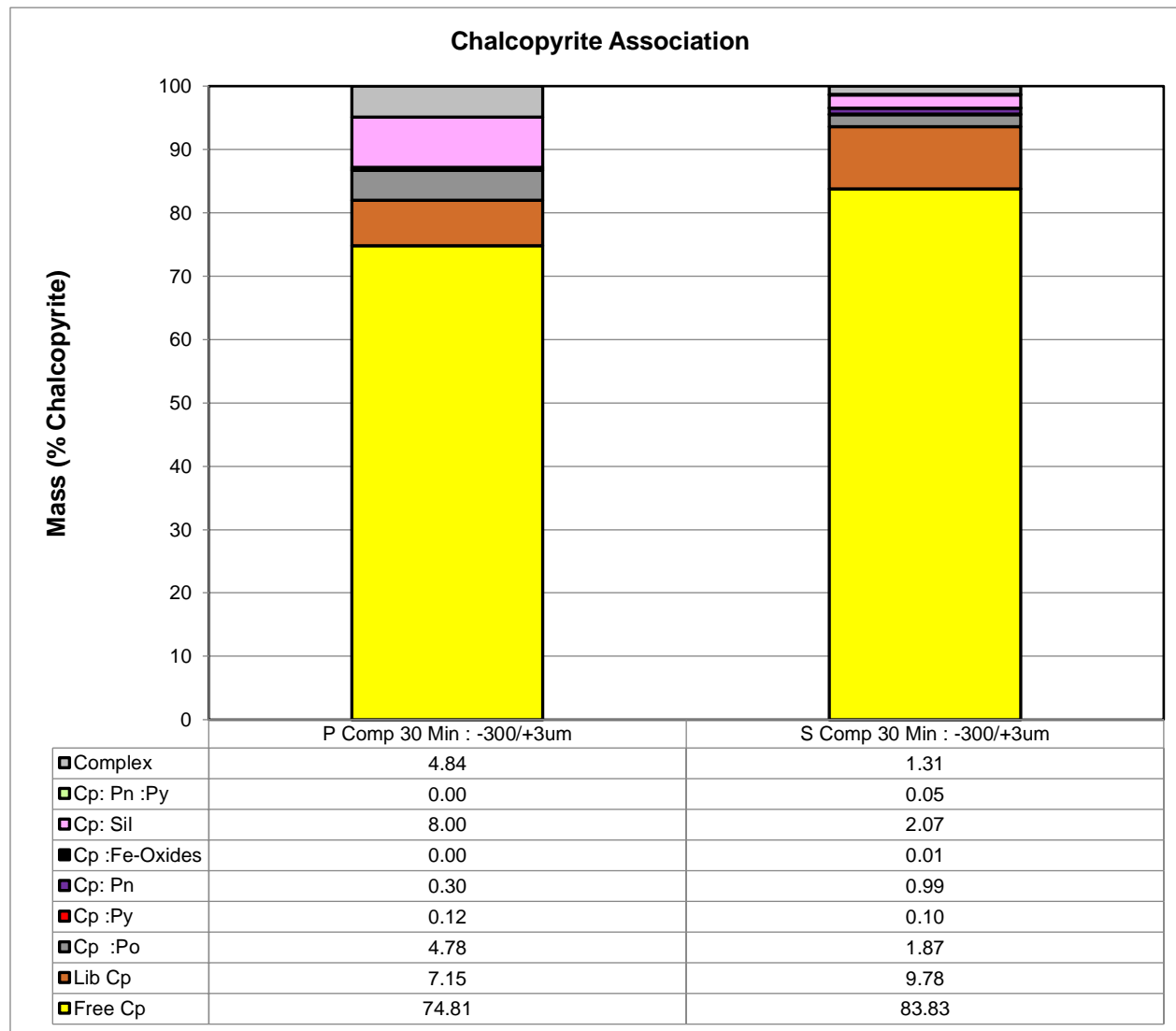

Normalized Mass of Chalcopyrite Across Samples

Mineral Name	P Comp 30 Min : -300/+3um	S Comp 30 Min : -300/+3um
Free Cp	74.81	83.83
Lib Cp	7.15	9.78
Cp :Po	4.78	1.87
Cp :Py	0.12	0.10
Cp: Pn	0.30	0.99
Cp :Fe-Oxides	0.00	0.01
Cp: Sil	8.00	2.07
Cp: Pn :Py	0.00	0.05
Complex	4.84	1.31
Total	100.00	100.00

North American Nickel
18559-01
MI5046-JUN21

High Definition Mineralogical Analysis using

Image Grid - Pyrrhotite Association

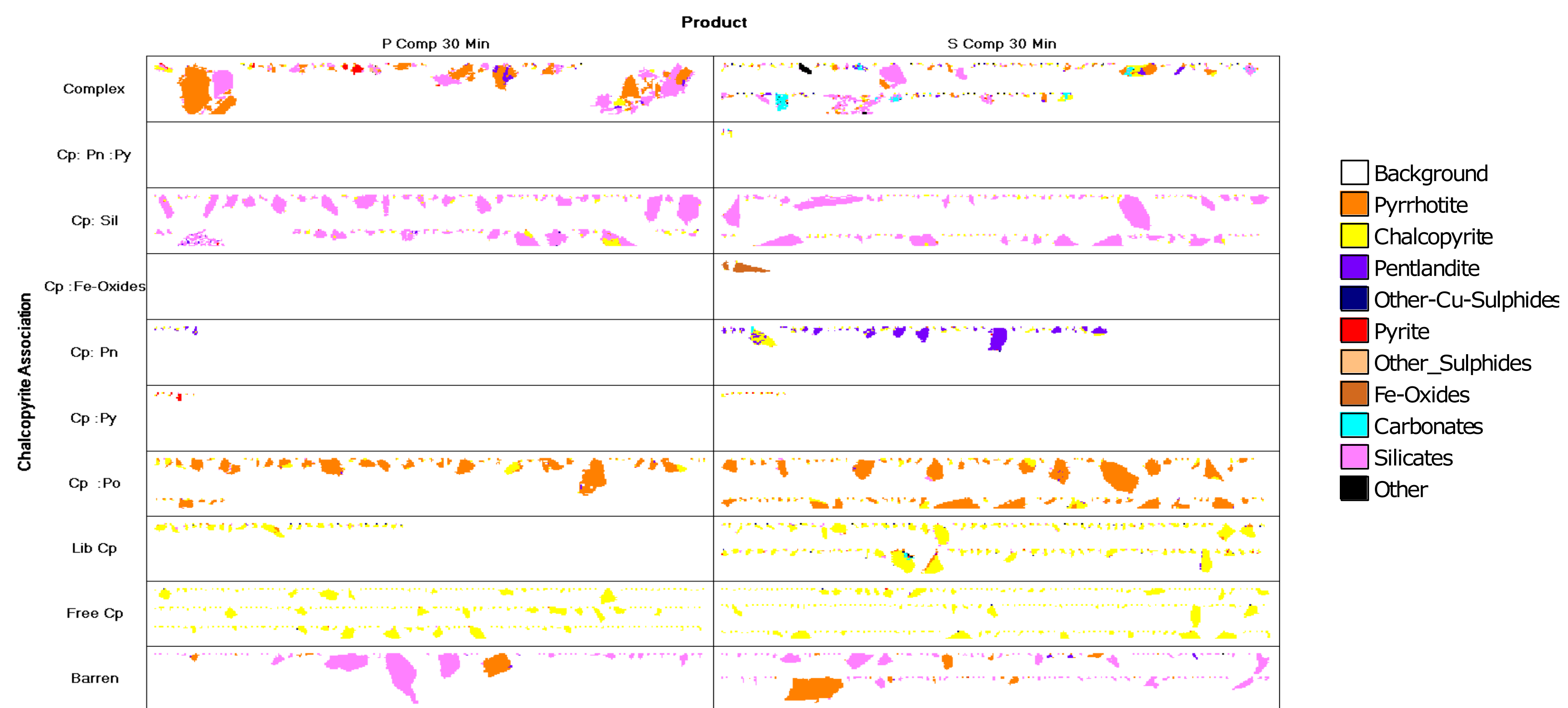

North American Nickel
 18559-01
 MI5046-JUN21

High Definition Mineralogical Analysis using QEMSCAN (Quantitative Evaluation of Materials by Scanning Electron Microscopy)

Pyrite Liberation

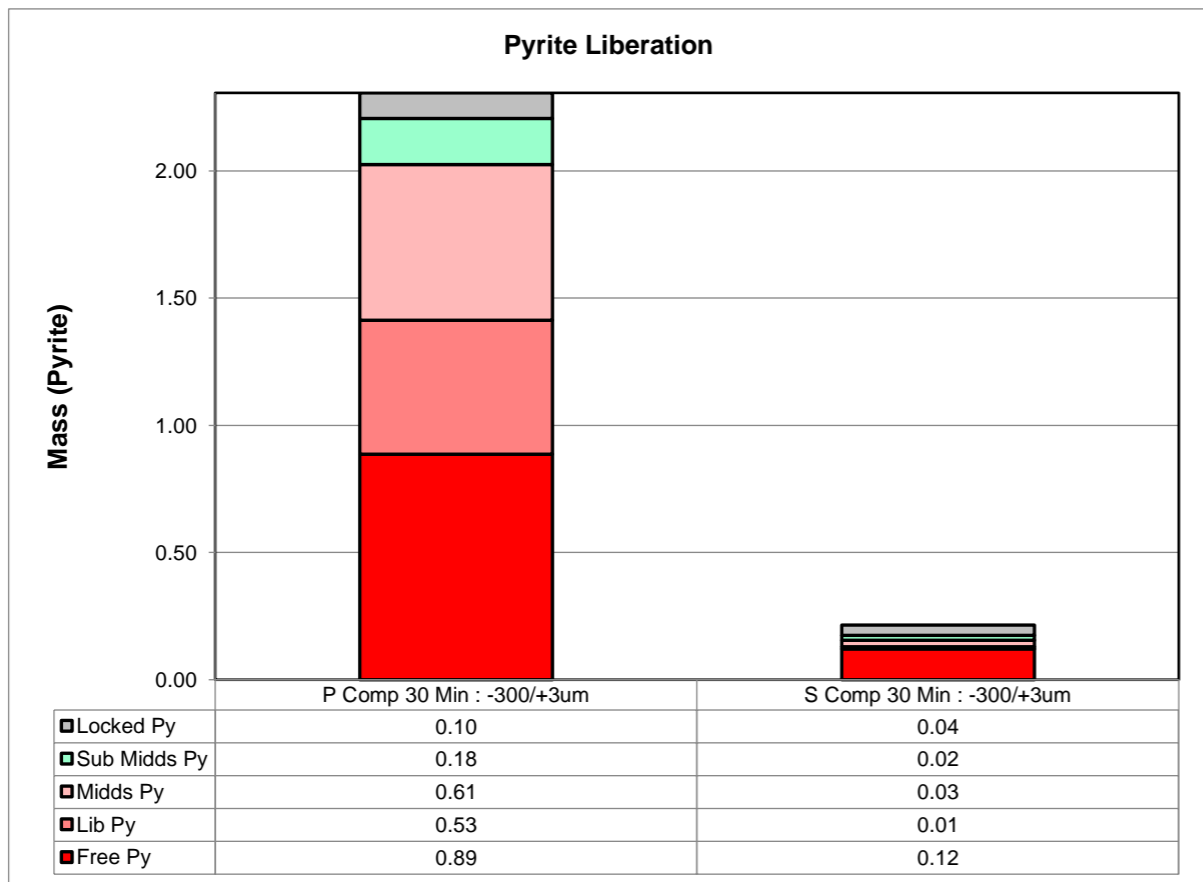

Absolute Mass of Pyrite Across Samples

Mineral Name	P Comp 30 Min : -300/+3um	S Comp 30 Min : -300/+3um
Free Py	0.89	0.12
Lib Py	0.53	0.01
Midds Py	0.61	0.03
Sub Midds Py	0.18	0.02
Locked Py	0.10	0.04
Total	2.31	0.22

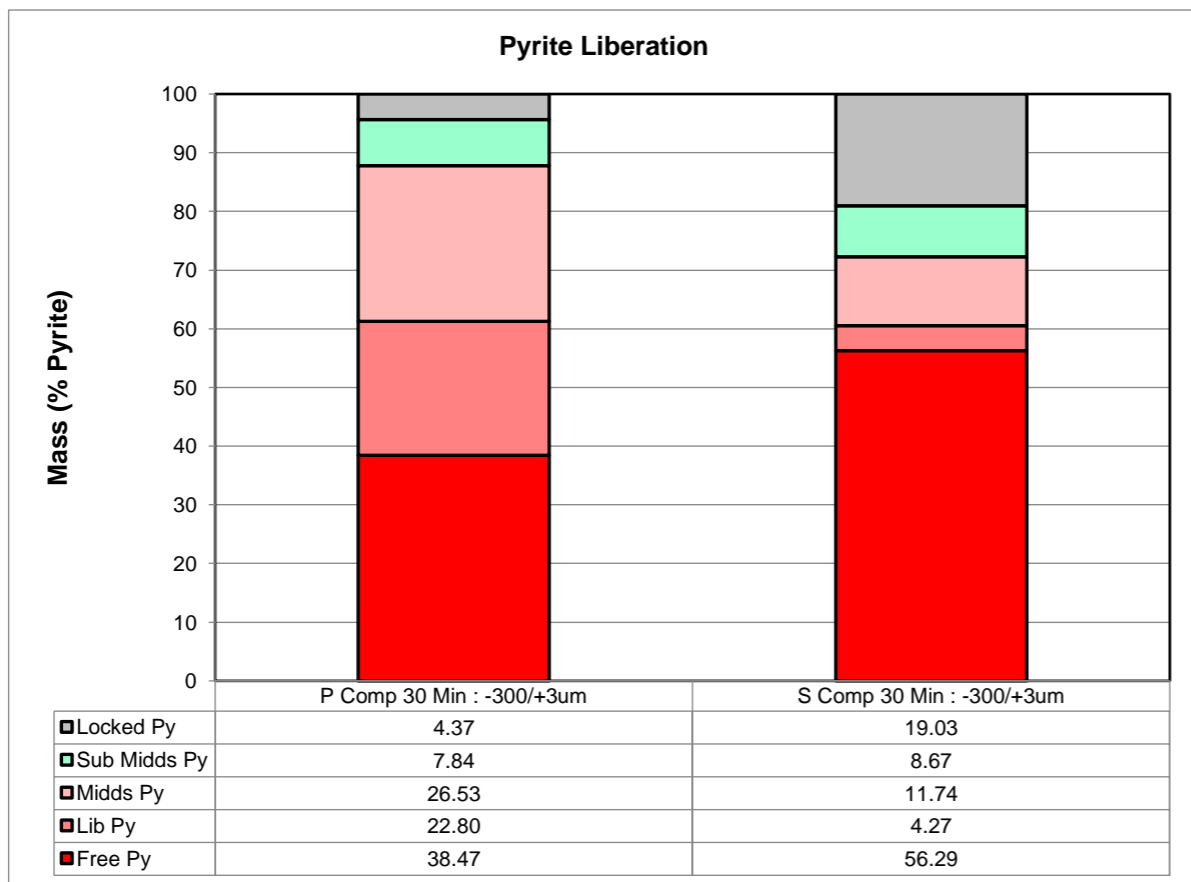

Normalized Mass of Pyrite Across Samples

Mineral Name	P Comp 30 Min : -300/+3um	S Comp 30 Min : -300/+3um
Free Py	38.47	56.29
Lib Py	22.80	4.27
Midds Py	26.53	11.74
Sub Midds Py	7.84	8.67
Locked Py	4.37	19.03
Total	100.00	100.00

North American Nickel
18559-01
MI5046-JUN21

High Definition Mineralogical Analysis using QEMSCAN (Quantitative Evaluation of Materials by Scanning Electron Microscopy)

Pyrite Association

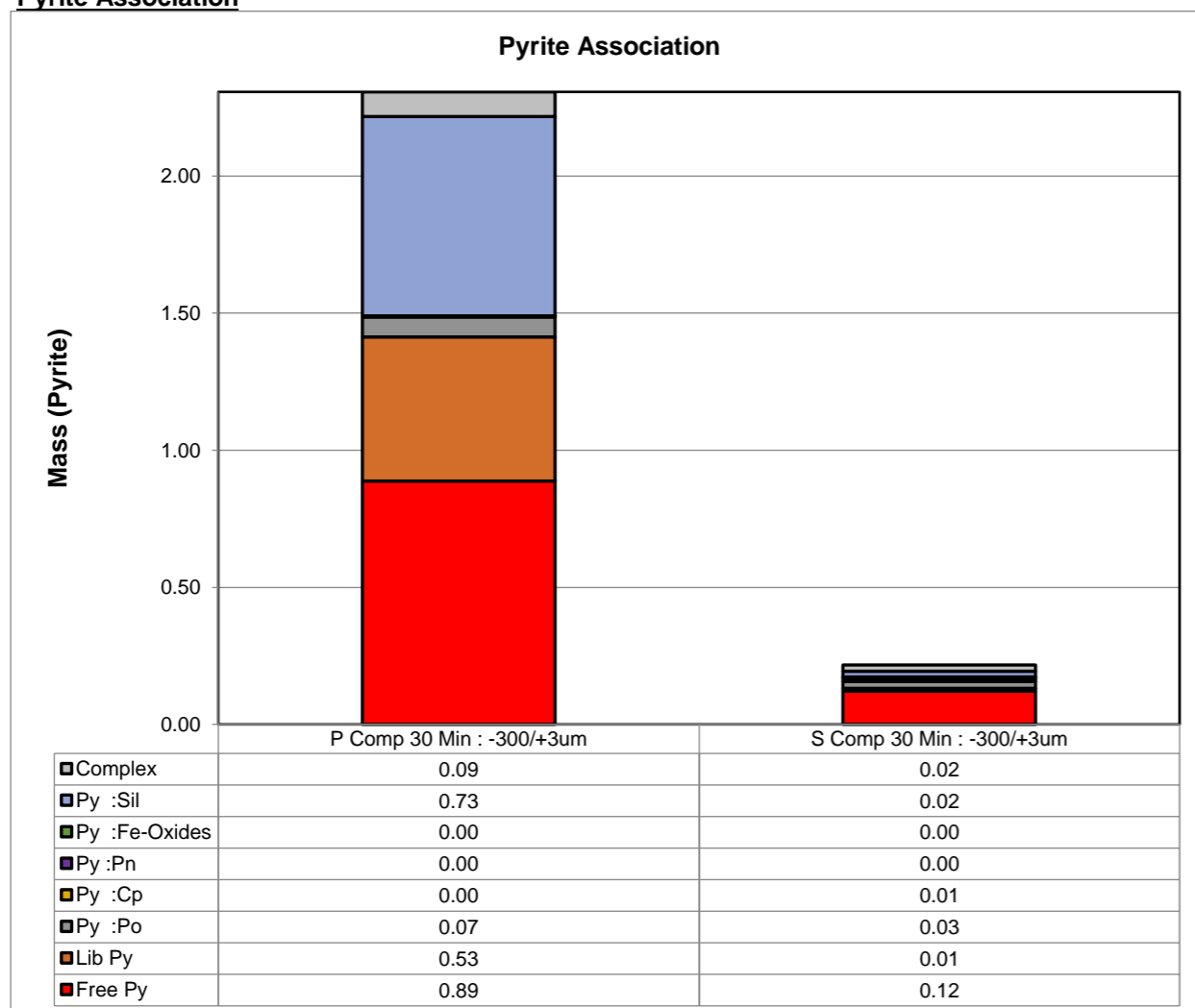

Absolute Mass of Pyrite Across Samples

Mineral Name	P Comp 30 Min : -300/+3um	S Comp 30 Min : -300/+3um
Free Py	0.89	0.12
Lib Py	0.53	0.01
Py :Po	0.07	0.03
Py :Cp	0.00	0.01
Py :Pn	0.00	0.00
Py :Fe-Oxides	0.00	0.00
Py :Sil	0.73	0.02
Complex	0.09	0.02
Total	2.31	0.22

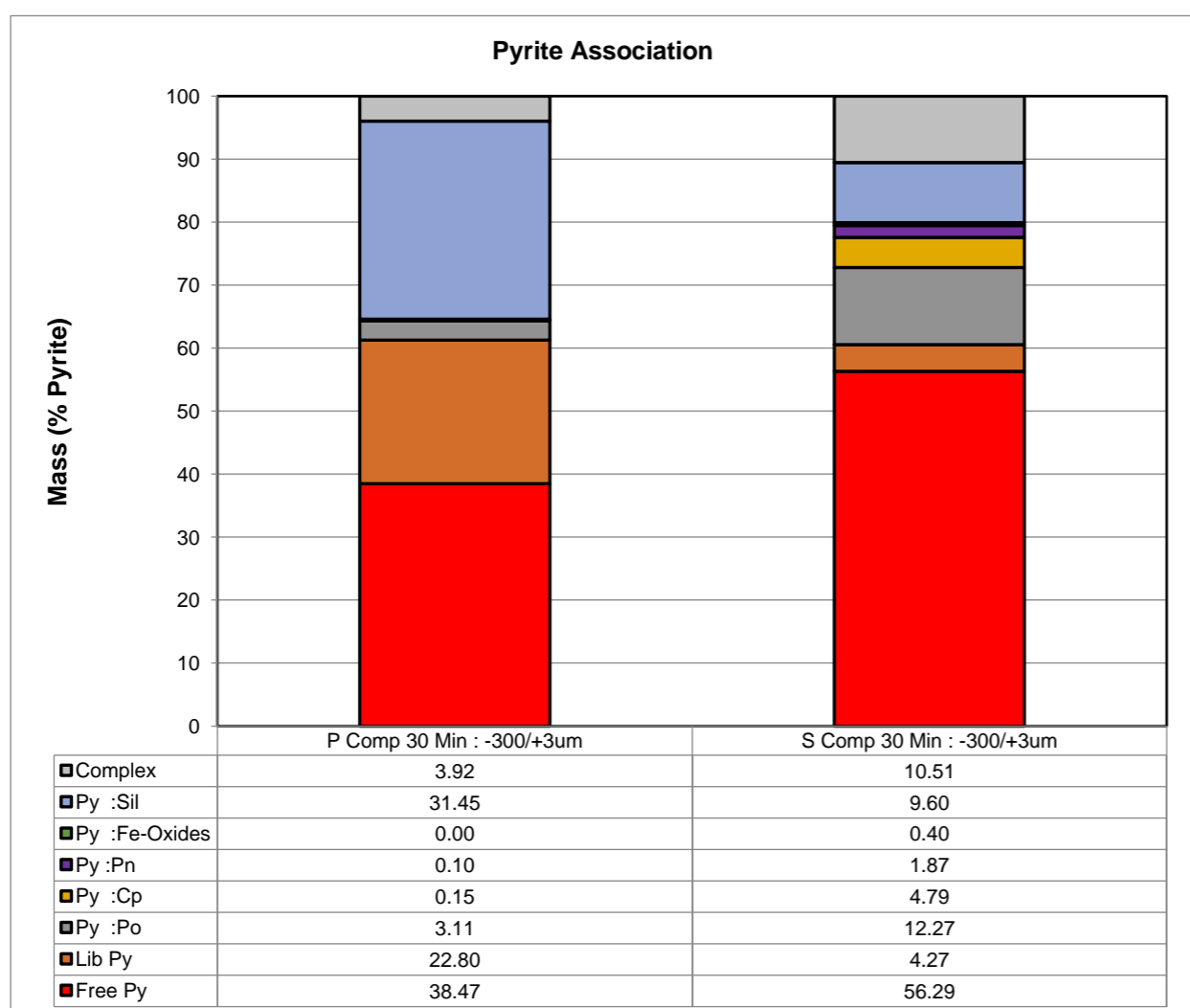

Normalized Mass of Pyrite Across Samples

Mineral Name	P Comp 30 Min : -300/+3um	S Comp 30 Min : -300/+3um
Free Py	38.47	56.29
Lib Py	22.80	4.27
Py :Po	3.11	12.27
Py :Cp	0.15	4.79
Py :Pn	0.10	1.87
Py :Fe-Oxides	0.00	0.40
Py :Sil	31.45	9.60
Complex	3.92	10.51
Total	100.00	100.00

North American Nickel
 18559-01
 MI5046-JUN21

High Definition Mineralogical Analysis using QEMSCAN (Quantitative Evaluation of Materials by Scanning Electron Microscopy)

Silicates Liberation

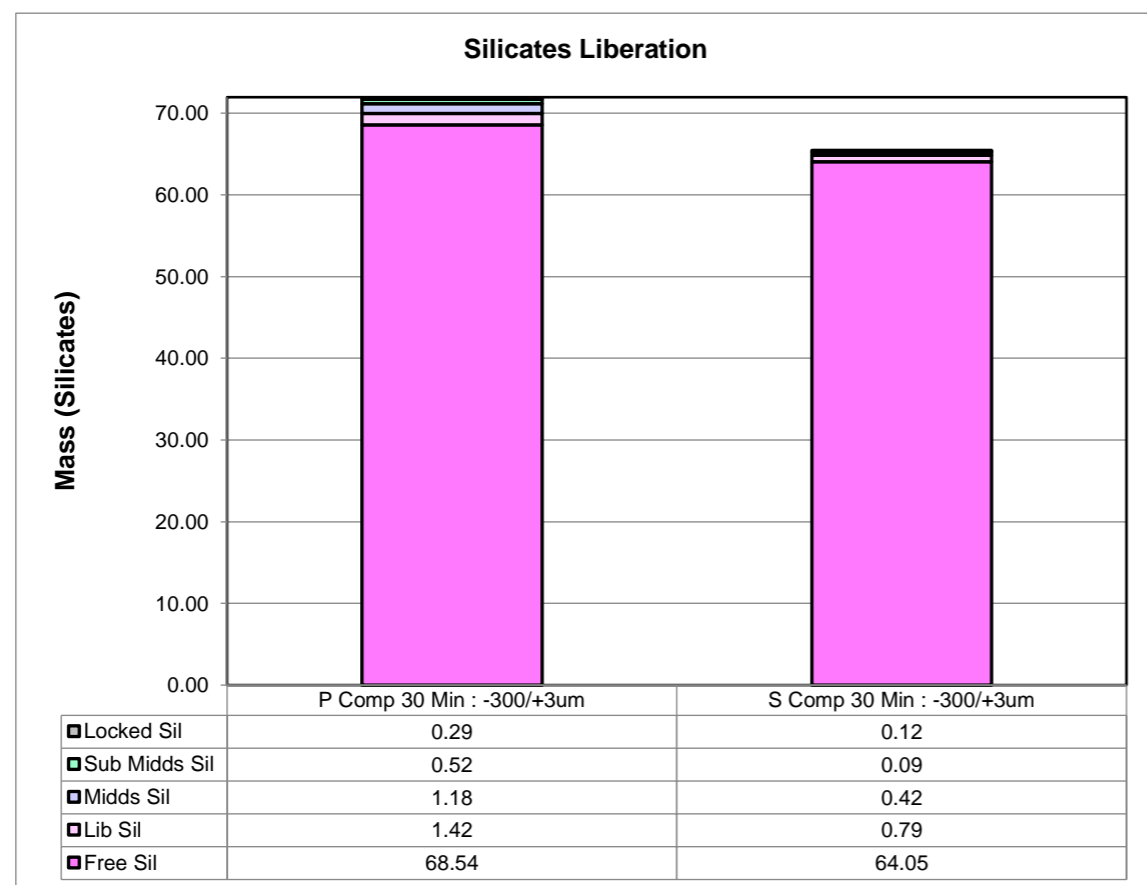

Absolute Mass of Silicates Across Samples

Mineral Name	P Comp 30 Min : -300/+3um	S Comp 30 Min : -300/+3um
Free Sil	68.54	64.05
Lib Sil	1.42	0.79
Midds Sil	1.18	0.42
Sub Midds Sil	0.52	0.09
Locked Sil	0.29	0.12
Total	71.95	65.47

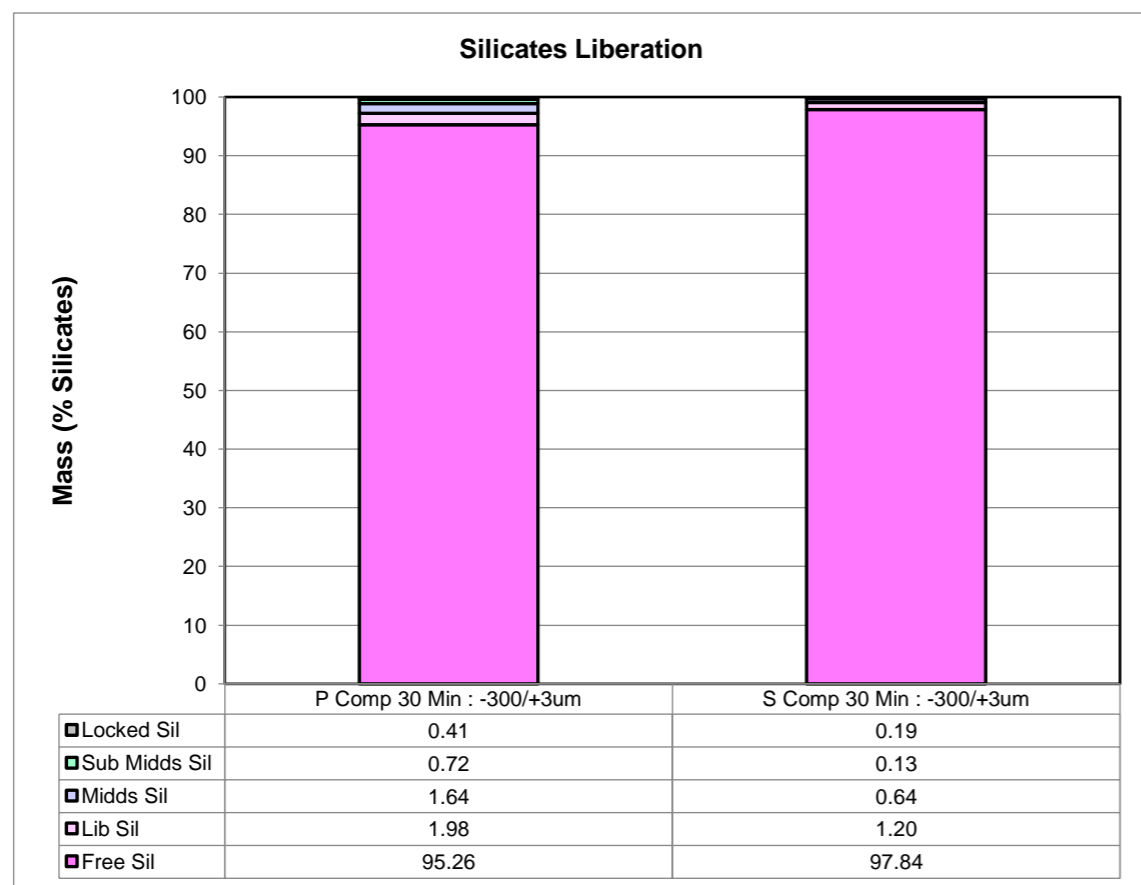

Normalized Mass of Silicates Across Samples

Mineral Name	P Comp 30 Min : -300/+3um	S Comp 30 Min : -300/+3um
Free Sil	95.26	97.84
Lib Sil	1.98	1.20
Midds Sil	1.64	0.64
Sub Midds Sil	0.72	0.13
Locked Sil	0.41	0.19
Total	100.00	100.00

North American Nickel
18559-01
MI5046-JUN21

High Definition Mineralogical Analysis using QEMSCAN (Quantitative Evaluation of Materials by Scanning Electron Microscopy)

Silicates Association

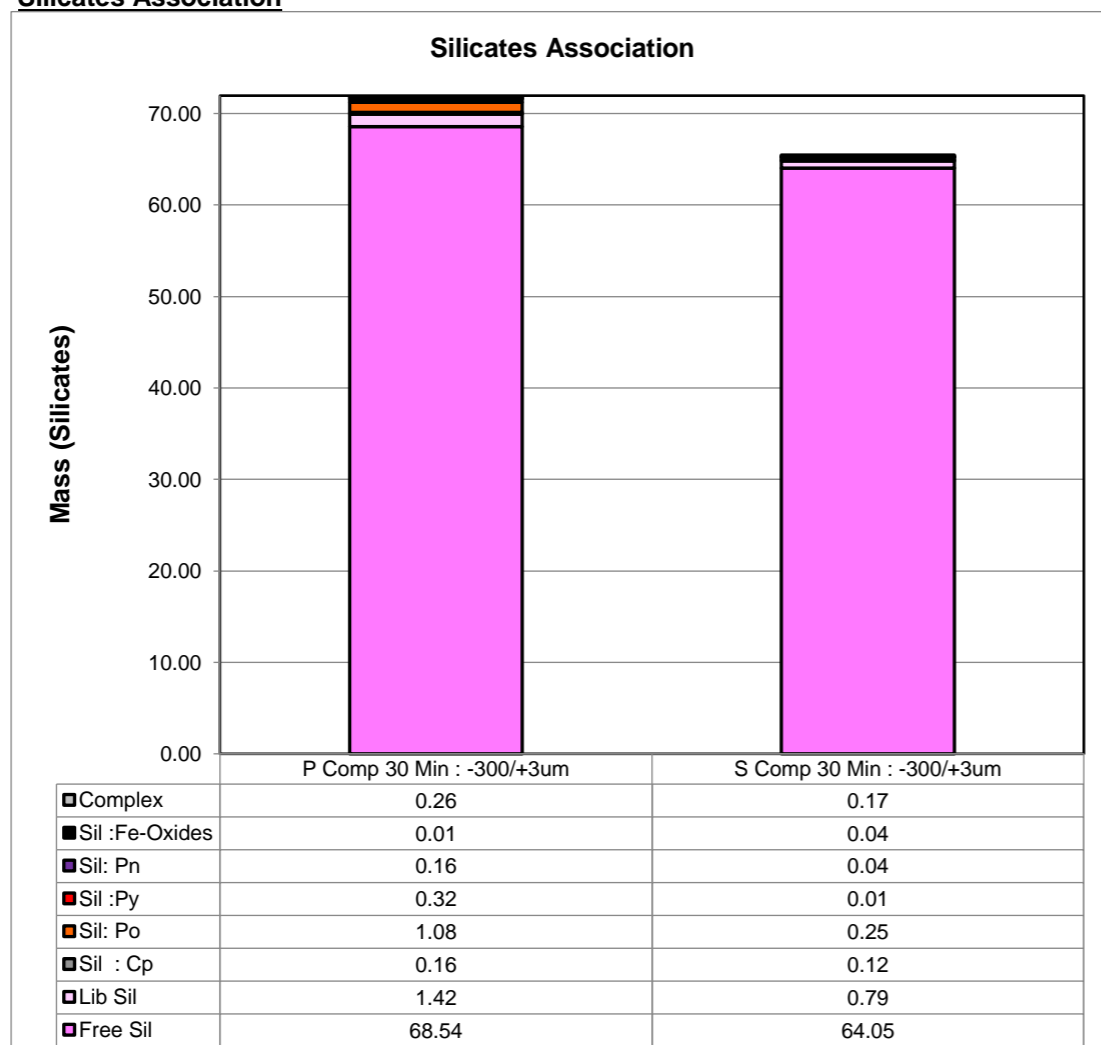

Absolute Mass of Silicates Across Samples

Mineral Name	P Comp 30 Min : -300/+3um	S Comp 30 Min : -300/+3um
Free Sil	68.54	64.05
Lib Sil	1.42	0.79
Sil : Cp	0.16	0.12
Sil: Po	1.08	0.25
Sil :Py	0.32	0.01
Sil: Pn	0.16	0.04
Sil :Fe-Oxides	0.01	0.04
Complex	0.26	0.17
Total	71.95	65.47

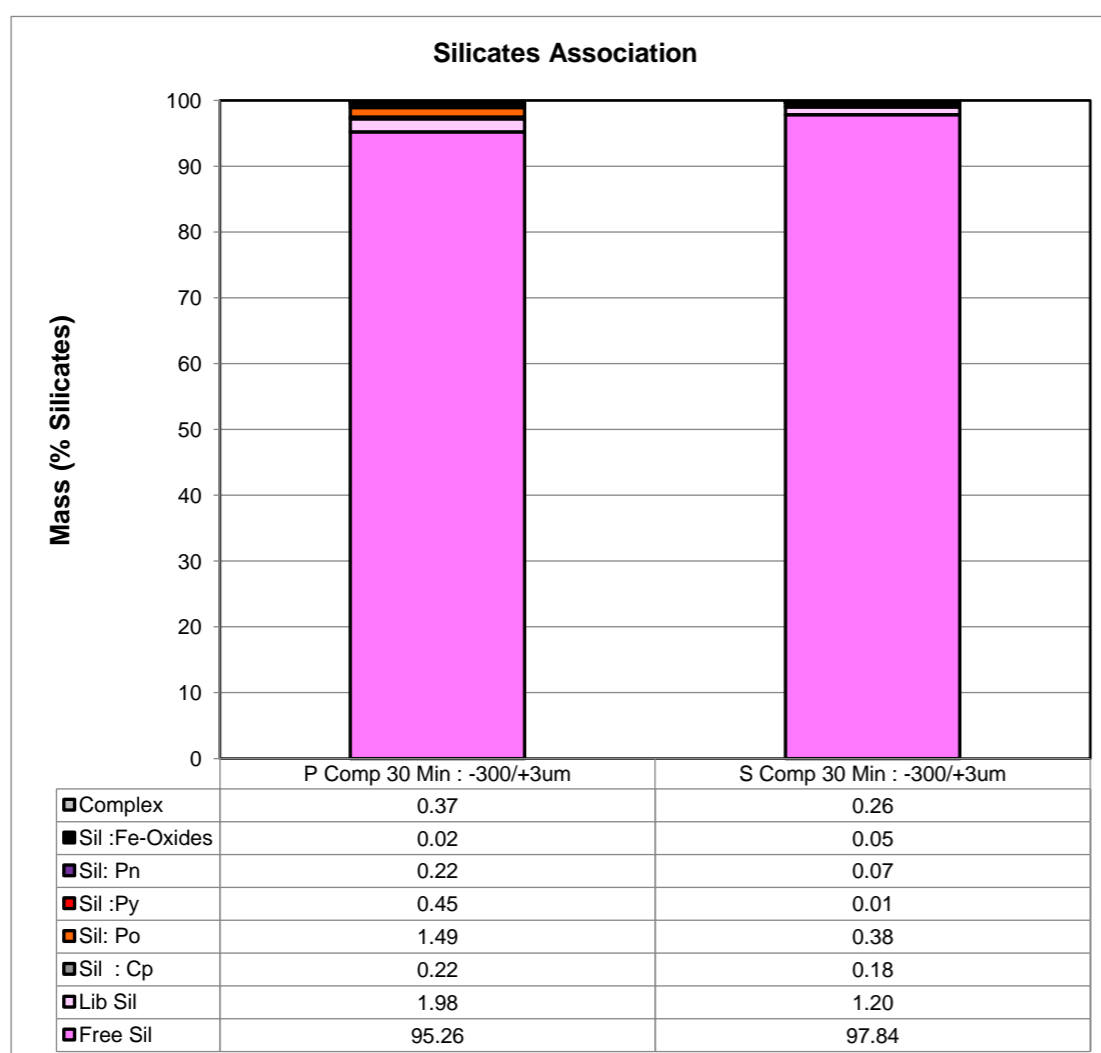

Normalized Mass of Silicates Across Samples

Mineral Name	P Comp 30 Min : -300/+3um	S Comp 30 Min : -300/+3um
Free Sil	95.26	97.84
Lib Sil	1.98	1.20
Sil : Cp	0.22	0.18
Sil: Po	1.49	0.38
Sil :Py	0.45	0.01
Sil: Pn	0.22	0.07
Sil :Fe-Oxides	0.02	0.05
Complex	0.37	0.26
Total	100.00	100.00

North American Nickel
18559-01
MI5046-JUN21

High Definition Mineralogical Analysis using QEMSCAN (Quantitative Evaluation of Materials by Scanning Electron Microscopy)

Cumulative Retained Grain Size Distribution

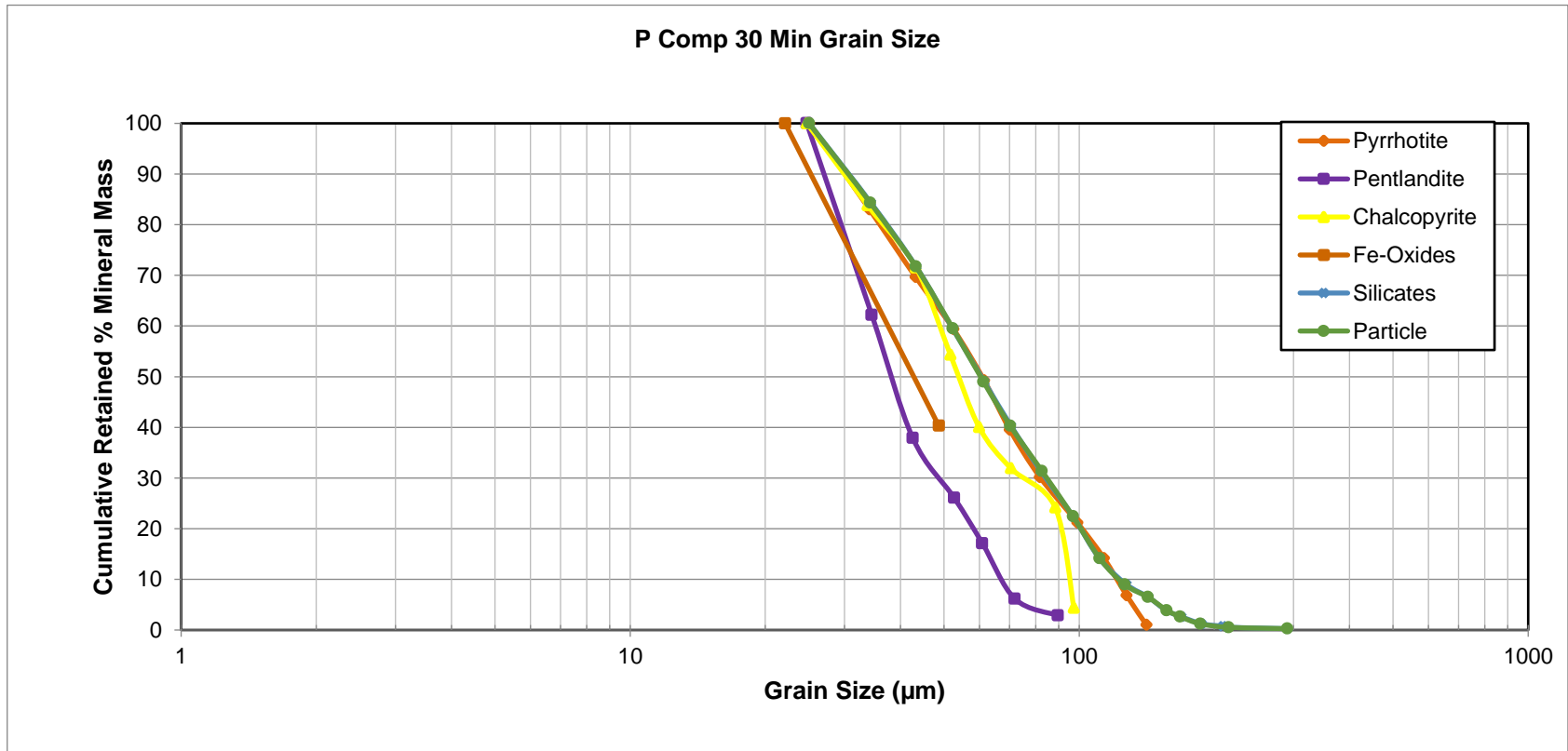

North American Nickel
18559-01
MI5046-JUN21

High Definition Mineralogical Analysis using QEMSCAN (Quantitative Evaluation of Materials by Scanning Electron Microscopy)

Cumulative Retained Grain Size Distribution

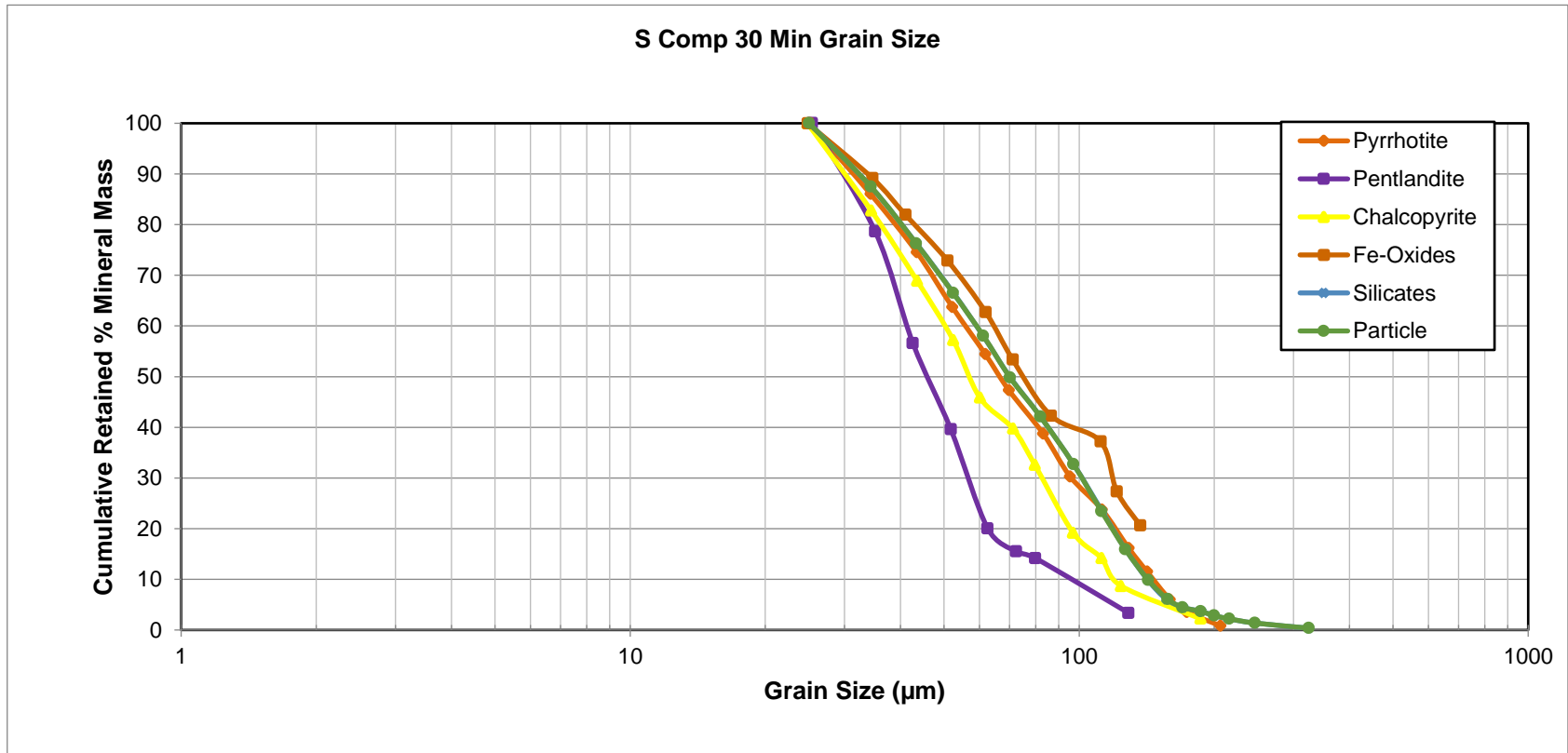

North American Nickel
18559-01
MI5046-JUN21

High Definition Mineralogical Analysis using QEMSCAN (Quantitative Evaluation of Materials by Scanning Electron Microscopy)

Copper Grade vs. Recovery:

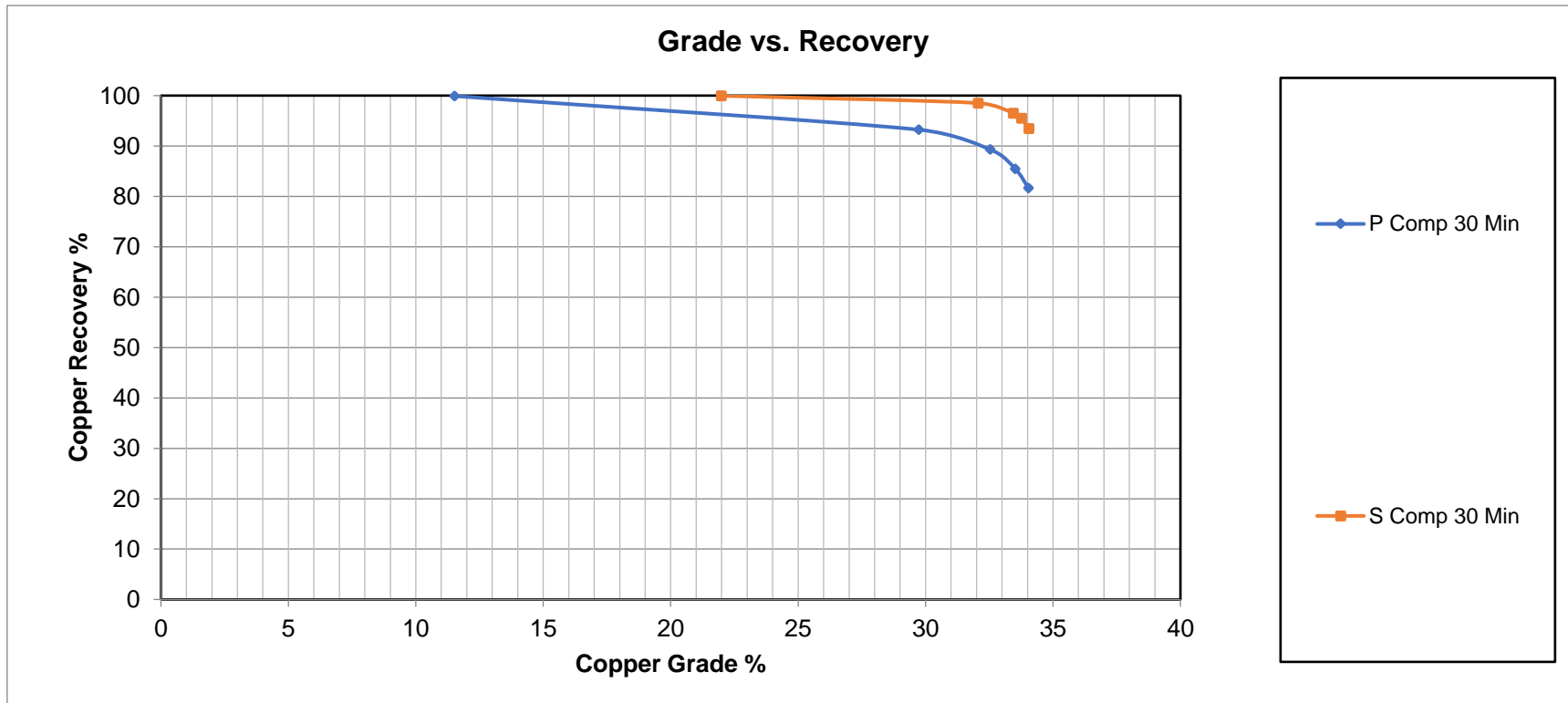

North American Nickel
18559-01
MI5046-JUN21

High Definition Mineralogical Analysis using QEMSCAN (Quantitative Evaluation of Materials by Scanning Electron Microscopy)

Nickle Grade vs. Recovery:

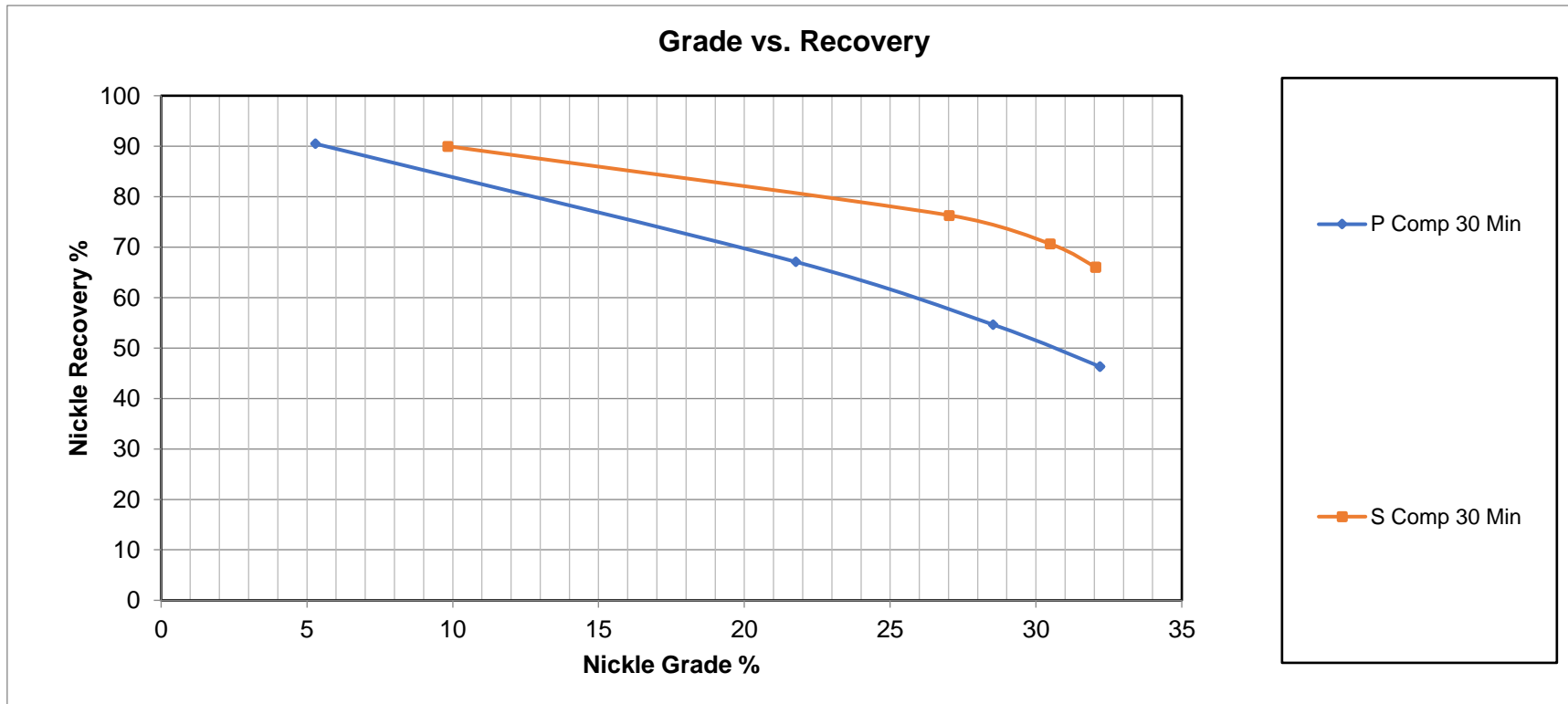

Appendix C – Grindability Testing

SMC TEST[®] REPORT

North American Nickel

Tested by: SGS Minerals Services

Ontario, Canada

Prepared by: Matt Weier

JKTech Job No: 21007/P33

Testing Date: August 2021



Contents

1	Executive Summary	5
1.1	SMC Results Summary	5
2	Introduction.....	7
3	The SMC Test®	8
3.1	Introduction.....	8
3.2	General Description and Test Background	8
3.3	The Test Procedure.....	9
3.3.1	Particle Selection Method.....	9
3.3.2	Cut Core Method	10
3.4	SMC Test® Results.....	11
4	References	17
5	Disclaimer.....	18

Appendices

APPENDIX A.	SAG Circuit Specific Energy (SCSE).....	20
APPENDIX B.	Background And Use Of The SMC Test®	24

List Of Figures

<i>Figure 1 - Frequency Distribution of A*b in the JKTech Database.....</i>	<i>6</i>
<i>Figure 2 - Frequency Distribution of SCSE in the JKTech Database</i>	<i>6</i>
<i>Figure 3 – Relationship between Particle Size and A*b.....</i>	<i>9</i>
<i>Figure 4 – A Typical Set of Particles for Breakage (Particle Selection Method).....</i>	<i>10</i>
<i>Figure 5 – Orientations of Pieces for Breakage (Cut Core Method)</i>	<i>11</i>
<i>Figure 6 – Cumulative Distribution of DWi Values in SMCT Database.....</i>	<i>14</i>
<i>Figure 7 - Cumulative Distribution of Mia, Mih and Mic Values in the SMCT Database.....</i>	<i>14</i>
<i>Figure 8 - Frequency Distribution of A*b in the JKTech Database.....</i>	<i>16</i>
<i>Figure 9 - Frequency Distribution of SCSE in the JKTech Database</i>	<i>16</i>

List Of Tables

<i>Table 1 - SMC Test[®] Results.....</i>	<i>5</i>
<i>Table 2 – Parameters derived from the SMC Test[®] Results.....</i>	<i>5</i>
<i>Table 3 - SMC Test[®] Results.....</i>	<i>12</i>
<i>Table 4 – Parameters derived from the SMC Test[®] Results.....</i>	<i>12</i>
<i>Table 5 – Crusher Simulation Model Specific Energy Matrix.....</i>	<i>13</i>
<i>Table 6 – Derived Values for A*b, ta and SCSE.....</i>	<i>15</i>

1 Executive Summary

1.1 SMC Results Summary

Table 1 - SMC Test® Results

Sample Designation	DWi (kWh/m ³)	DWi (%)	Mi Parameters (kWh/t)			SG
			Mia	Mih	Mic	
HG COMP	11.3	94.0	23.4	19.2	9.9	3.41
LG COMP	13.2	99.0	28.7	24.3	12.6	3.15
P COMP	6.0	41.0	15.3	11.1	5.7	3.13
S COMP	2.5	7.0	6.8	4.1	2.1	3.49
SN COMP	2.6	8.0	6.6	4.1	2.1	3.73

Table 2 – Parameters derived from the SMC Test® Results

Sample Designation	A	b	A*b	t _a	SCSE (kWh/t)
HG COMP	73.3	0.41	30.1	0.23	12.79
LG COMP	99.5	0.24	23.9	0.20	14.31
P COMP	68.1	0.77	52.4	0.43	9.45
S COMP	74.3	1.89	140.4	1.04	6.23
SN COMP	77.7	1.84	143.0	0.99	6.04

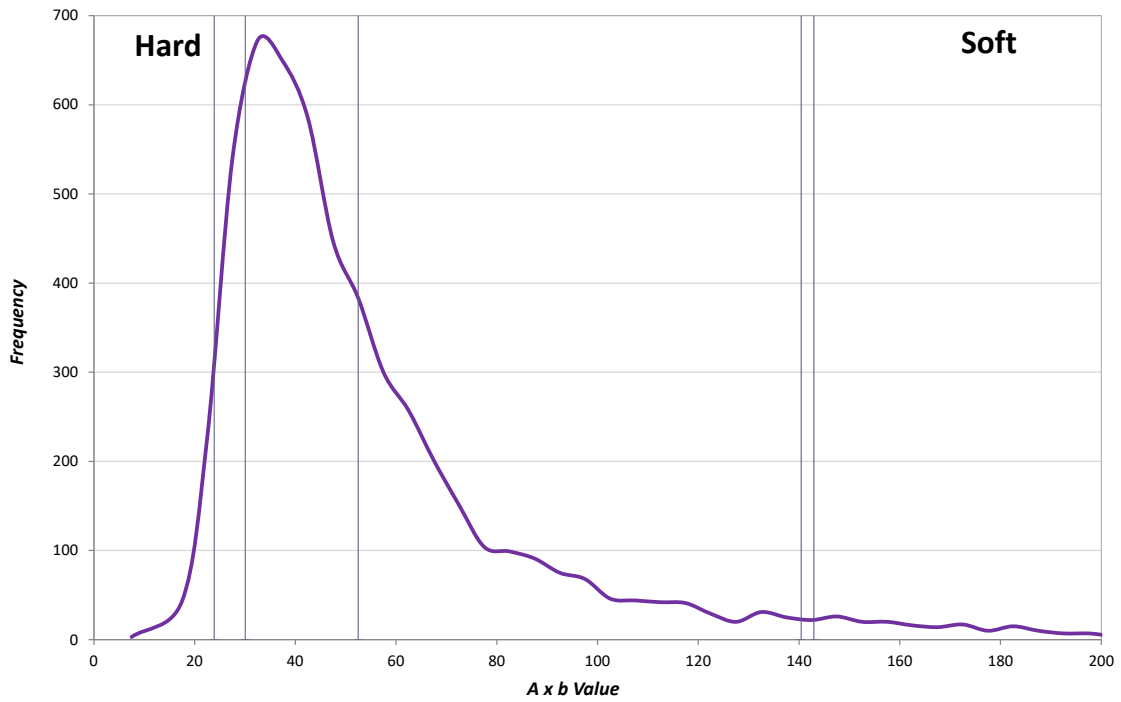

Figure 1 - Frequency Distribution of A*b in the JKTech Database

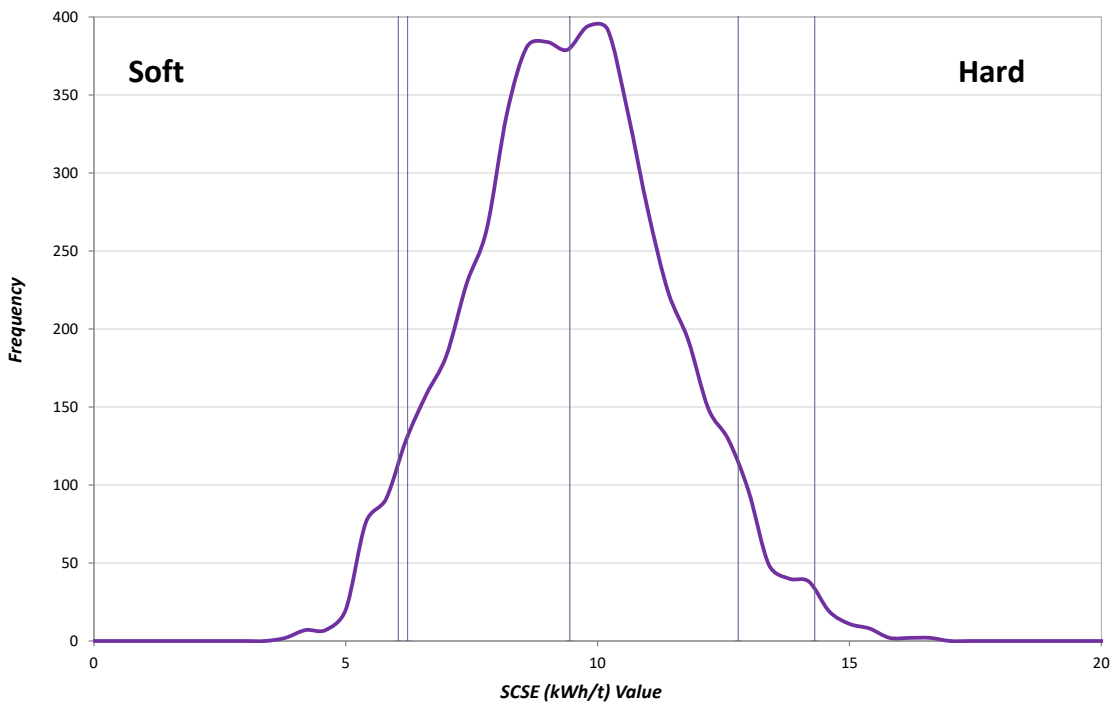

Figure 2 - Frequency Distribution of SCSE in the JKTech Database

2 Introduction

SMC data for five samples from Phikwe Selebi Project were received from SGS Minerals Services on August 31, 2021, by JKTech for SMC test analysis. The samples were identified as HG COMP, LG COMP, P COMP, S COMP and SN COMP. The data were analysed to determine the JKSimMet and SMC Test comminution parameters. SMC Test results were forwarded to SMC Testing Pty Ltd for the analysis of the SMC Test data. Analysis and reporting were completed on September 01, 2021.

Some samples in this report have been previously reported as JKTech job 21007/P27. They have been included at SGS Minerals Services request.

3 The SMC Test[®]

3.1 Introduction

The standard JK Drop-Weight test provides ore specific parameters for use in the JKSimMet Mineral Processing Simulator software. In JKSimMet, these parameters are combined with equipment details and operating conditions to analyse and/or predict SAG/autogenous mill performance. The same test procedure also provides ore type characterisation for the JKSimMet crusher model.

The SMC Test was developed by Steve Morrell of SMC Testing Pty Ltd (SMCT). The test provides a cost effective means of obtaining these parameters, in addition to a range of other power-based comminution parameters, from drill core or in situations where limited quantities of material are available. The ore specific parameters have been calculated from the test results and are supplied to North American Nickel in this report as part of the standard procedure

3.2 General Description and Test Background

The SMC Test[®] was originally designed for the breakage characterisation of drill core and it generates a relationship between input energy (kWh/t) and the percent of broken product passing a specified sieve size. The results are used to determine the so-called JK Drop-Weight index (DWi), which is a measure of the strength of the rock when broken under impact conditions and has the units kWh/m³. The DWi is directly related to the JK rock breakage parameters A and b and hence can be used to estimate the values of these parameters as well as being correlated with the JK abrasion parameter - t_a . For crusher modelling the t_{10} - E_{cs} matrix can also be derived. This is done by using the size-by-size $A*b$ values that are used in the SMC Test[®] data analysis (see below) to estimate the t_{10} - E_{cs} values for each of the relevant size fractions in the crusher model matrix.

For power-based calculations, (see APPENDIX B), the SMC Test[®] provides the comminution parameters M_{ia} , M_{ih} and M_{ic} . M_{ia} is the work index for the grinding of coarser particles (> 750 μ m) in tumbling mills such as autogenous (AG), semi-autogenous (SAG), rod and ball mills. M_{ih} is the work index for the grinding in High Pressure Grinding Rolls (HPGR) and M_{ic} for size reduction in conventional crushers.

The SMC Test[®] is a precision test, which uses particles that are either cut from drill core using a diamond saw to achieve close size replication or else selected from crushed material so that particle mass variation is controlled within a prescribed range. The particles are then broken at a number of prescribed impact energies. The high degree of control imposed on both the size of particles and the breakage energies used, means that the test is largely free of the repeatability problems associated with tumbling-mill based tests. Such tests usually suffer from variations in feed size (which is not closely controlled) and energy input, often assumed to be constant when in reality it can be highly variable (Levin, 1989).

The relationship between the DWi and the JK rock breakage parameters makes use of the size-by-size nature of rock strength that is often apparent from the results of full JK Drop-Weight tests. The effect is illustrated in Figure 3, which plots the normalized values of $A*b$ against particle size. This figure also shows how the gradient of these plots varies across the full range of rock types tested. In the case of a conventional JK Drop-Weight test, these values are effectively averaged and a mean value of A and b is reported. The SMC Test[®] uses a single size and makes use of relationships such as that shown in Figure 3 to predict the A and b of the particle size that has the same value as the mean for a JK full Drop-Weight test.

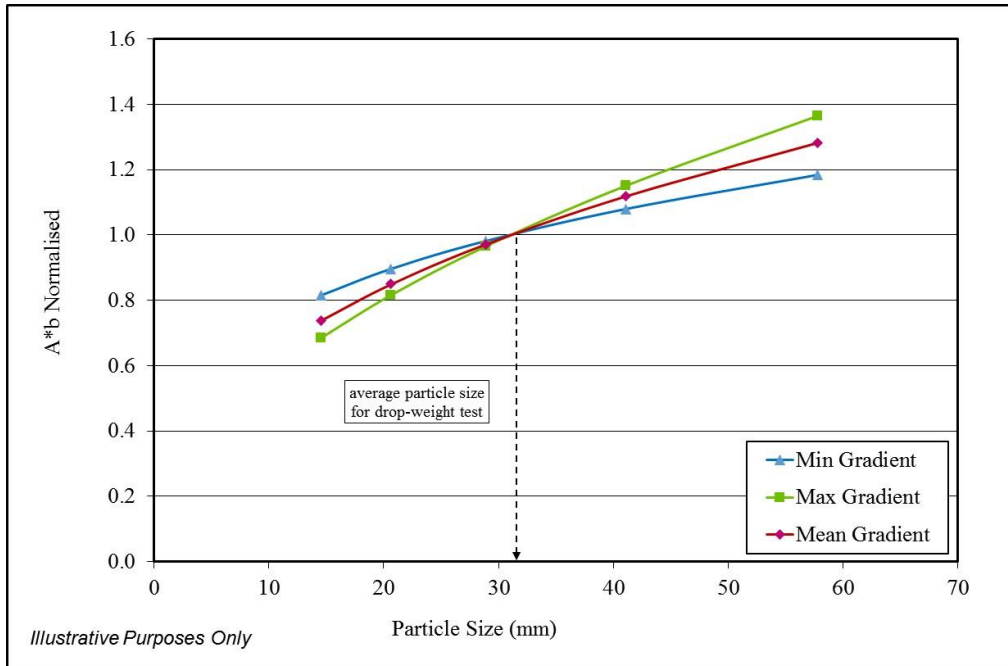

Figure 3 – Relationship between Particle Size and A*b

3.3 The Test Procedure

In the SMC Test®, five sets of 20 particles are broken, each set at a different specific energy level, using a JK Drop-Weight tester. The breakage products are screened at a sieve size selected to provide a direct measurement of the t_{10} value.

The test calls for a prescribed target average volume for the particles, with the target being chosen to be equivalent to the mean volume of particles in one of the standard JK Drop-Weight test size fractions.

The rest height of the drop-head (gap) is recorded after breakage of each particle to allow for a correction to the drop energy. After breaking all 20 particles in a set, the broken product is sieved at an aperture size, one tenth of the original particle size. Thus, the percent passing mass gives a direct reading of the t_{10} value for breakage at that energy level.

There are two alternative methods of preparing the particle sets for breakage testing: the particle selection method and the cut core method. The particle selection method is the most commonly used as it is generally less time consuming. The cut core method requires less material, so tends to be used as a fallback method, only when necessary to cope with restricted sample availability.

3.3.1 Particle Selection Method

For the particle selection method, the test is carried out on material in one of three alternative size fractions: -31.5+26.5, -22.4+19 or -16+13.2 mm. The largest size fraction is preferred but requires more material.

In the particle selection method, particles are chosen so that their individual masses lie within $\pm 30\%$ of the target mass and the mean mass for each set of 20 lies within $\pm 10\%$ of the target mass. A typical set of particles is shown in Figure 4.



Figure 4 – A Typical Set of Particles for Breakage (Particle Selection Method)

Before commencing breakage tests on the particles, the ore density is determined by first weighing a representative sample of particles in air and then in water.

3.3.2 Cut Core Method

The cut core method uses cut pieces of quartered (slivered) drill core. Whole core or half core can be used, but when received in this form it needs to be first quartered as a preliminary step in the procedure. Once quartered, any broken or tapered ends of the quartered lengths are cut, to square them off. Before the lengths of quartered core are cut to produce the pieces for testing, each one is weighed in air and then in water, to obtain a density measurement and a measure of its mass per unit length.

The size fraction targeted when the cut core method is used depends on the original core diameter. The target size fraction is selected to ensure that pieces of the correct volume will have “chunky” rather than “slabby” proportions.

Having measured the density of the core, the target volume can be translated into a target mass and with the average mass per unit length also known, an average cutting interval can be determined for the core.

Sufficient pieces of the quartered core are cut to generate 100 particles. These are then divided into the five sets of 20 and broken in the JK Drop-Weight tester at the five different energy levels. Within each set, the three possible orientations of the particles are equally represented (as far as possible, given that there are 20 particles). The orientations prescribed for testing are shown in Figure 5.



Figure 5 – Orientations of Pieces for Breakage (Cut Core Method)

The cut core method cannot be used for cores with diameters exceeding 70 mm, where the particle masses would be too large to achieve the highest prescribed energy level.

3.4 SMC Test[®] Results

The SMC Test[®] results for the HG COMP, LG COMP, P COMP, S COMP and SN COMP samples from Phikwe Selebi Project are given in Table 3. This table includes the average rock density and the DWi (Drop-Weight index) that is the direct result of the test procedure. The values determined for the M_{ia} , M_{in} and M_{ic} parameters developed by SMCT are also presented in this table. The M_{ia} parameter represents the coarse particle component (down to 750 μm), of the overall comminution energy and can be used together with the M_{ib} (fine particle component) to estimate the total energy requirements of a conventional comminution circuit. The use of these parameters is explained further in APPENDIX B. The derived estimates of parameters A , b and t_a that are required for JKSimMet comminution modelling are given in Table 4.

Also included in the derived results are the SAG Circuit Specific Energy (SCSE) values. The SCSE value is derived from simulations of a “standard” circuit comprising a SAG mill in closed circuit with a pebble crusher. This allows $A*b$ values to be described in a more meaningful form. SCSE is described in detail in APPENDIX A.

In the case of the HG COMP, LG COMP, P COMP, S COMP and SN COMP samples from Phikwe Selebi Project, the A and b estimates are based on a correlation using the database of all results so far accumulated by SMCT.

Table 3 - SMC Test® Results

Sample Designation	DWi (kWh/m ³)	DWi (%)	Mi Parameters (kWh/t)			SG
			Mia	Mih	Mic	
HG COMP	11.31	94	23.4	19.2	9.9	3.41
LG COMP	13.20	99	28.7	24.3	12.6	3.15
P COMP	5.98	41	15.3	11.1	5.7	3.13
S COMP	2.48	7	6.8	4.1	2.1	3.49
SN COMP	2.61	8	6.6	4.1	2.1	3.73

For more details on how the M_{ia} , M_{ih} and M_{ic} parameters are derived and used, see APPENDIX B or go to the SMC Testing website at <http://www.smctest.com/about>.

Table 4 – Parameters derived from the SMC Test® Results

Sample Designation	A	b	t_a	SCSE (kWh/t)
HG COMP	73.3	0.41	0.23	12.79
LG COMP	99.5	0.24	0.20	14.31
P COMP	68.1	0.77	0.43	9.45
S COMP	74.3	1.89	1.04	6.23
SN COMP	77.7	1.84	0.99	6.04

The influence of particle size on the specific comminution energy needed to achieve a particular t_{10} value can also be inferred from the SMC Test® results. The energy requirements for five particle sizes, each crushed to three different t_{10} values, are presented in Table 5.

Table 5 – Crusher Simulation Model Specific Energy Matrix

Sample Designation	Particle Size (mm)														
	14.5			20.6			28.9			41.1			57.8		
	<i>t₁₀</i> Values (%) for Given Specific Energies in kWh/t														
	10	20	30	10	20	30	10	20	30	10	20	30	10	20	30
HG COMP	0.46	1.01	1.66	0.40	0.88	1.45	0.35	0.76	1.26	0.30	0.66	1.09	0.27	0.58	0.96
LG COMP	0.57	1.22	1.94	0.50	1.06	1.69	0.44	0.92	1.48	0.38	0.80	1.27	0.33	0.70	1.12
P COMP	0.27	0.59	0.98	0.23	0.51	0.85	0.20	0.45	0.75	0.18	0.39	0.64	0.15	0.34	0.57
S COMP	0.10	0.22	0.36	0.09	0.19	0.31	0.08	0.16	0.27	0.07	0.14	0.23	0.06	0.12	0.20
SN COMP	0.10	0.21	0.35	0.08	0.18	0.30	0.07	0.16	0.26	0.06	0.14	0.23	0.06	0.12	0.20

The SMC Test® database now contains over 40,000 test results on samples representing more than 1300 different deposits worldwide.

Around 99% of the DWi values lie in the range 0.5 to 14.0 kWh/m³, with soft ores being at the low end of this range and hard ores at the high end.

A cumulative graph of DWi values from the SMC Test® Database is shown in Figure 6 below. This graph can be used to compare the DWi of the material from Phikwe Selebi Project, with the entire population of ores in the SMCT database. The figures on the y-axis of the graph represent the percentages of all ores tested that are softer than the x-axis (DWi) value selected.

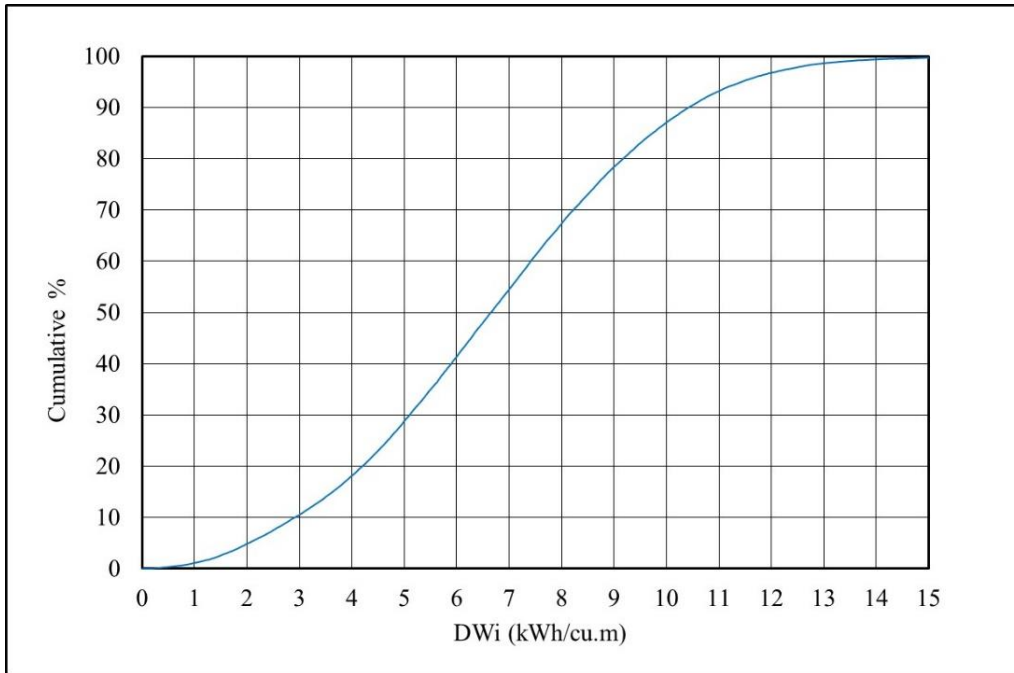

Figure 6 – Cumulative Distribution of DWi Values in SMCT Database

A further cumulative distribution graph is provided in Figure 7 to allow a comparison of the M_{ia} , M_{ih} and M_{ic} values obtained for the Phikwe Selebi Project material, with the entire population of values for these parameters contained in the SMCT database.

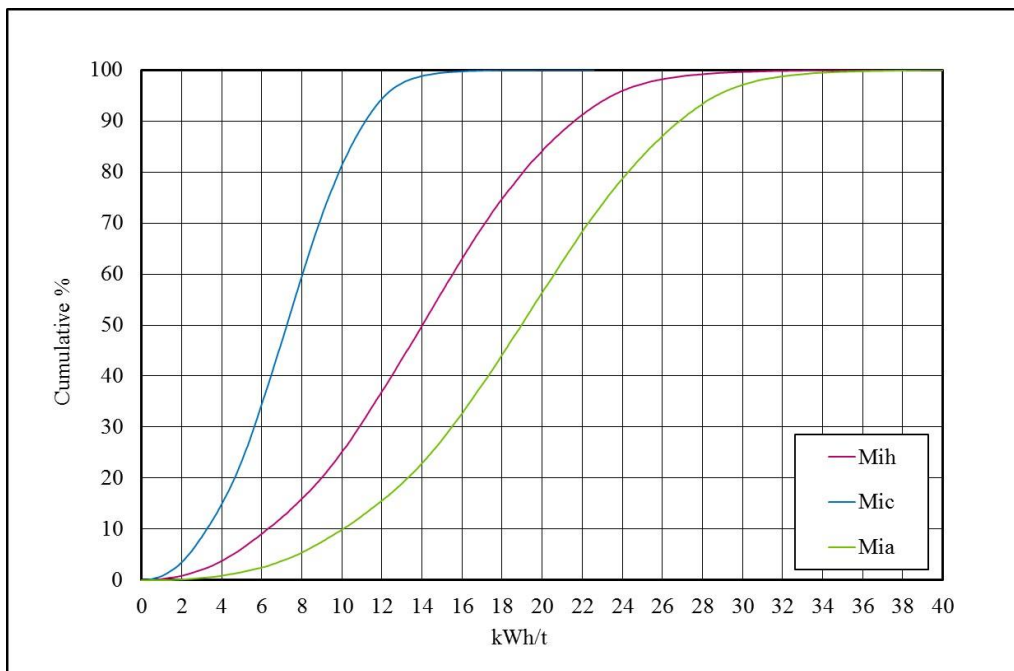

Figure 7 - Cumulative Distribution of Mia, Mih and Mic Values in the SMCT Database

The value of A^*b , which is also a measure of resistance to impact breakage, is calculated and presented in Table 6, which also gives a comparison to the population of samples in the JKTech database, with the percent of samples present in the JKTech database that are softer. Note that in contrast to the DWi, a high value of A^*b means that an ore is soft whilst a low value means that it is hard.

Table 6 – Derived Values for A^*b , t_a and SCSE

Sample Designation	A^*b		t_a		SCSE (kWh/t)	
	Value	%	Value	%	Value	%
HG COMP	30.1	85.0	0.23	89.4	12.79	94.6
LG COMP	23.9	96.4	0.20	93.8	14.31	99.1
P COMP	52.4	39.1	0.43	51.8	9.45	50.1
S COMP	140.4	6.2	1.04	12.2	6.23	5.3
SN COMP	143.0	6.0	0.99	13.3	6.04	4.2

In Figure 8 and Figure 9 below, histogram style frequency distributions for the A^*b values and for the SCSE values in the JKTech JKDW database are shown respectively.

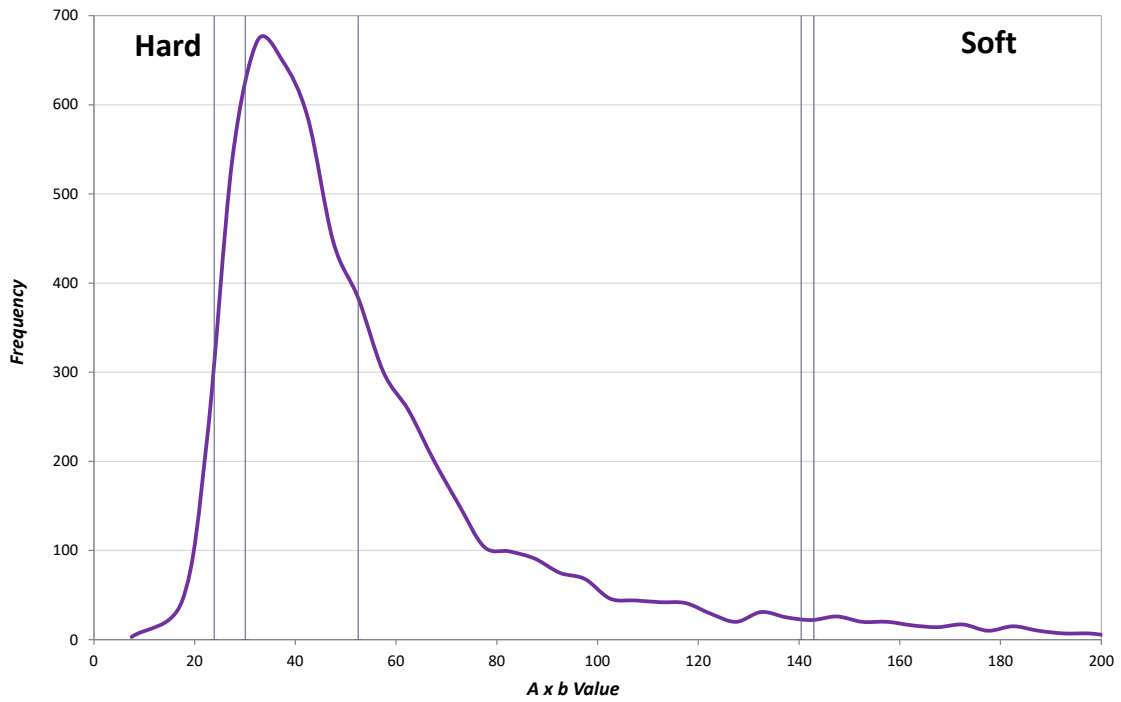

Figure 8 - Frequency Distribution of A*b in the JKTech Database

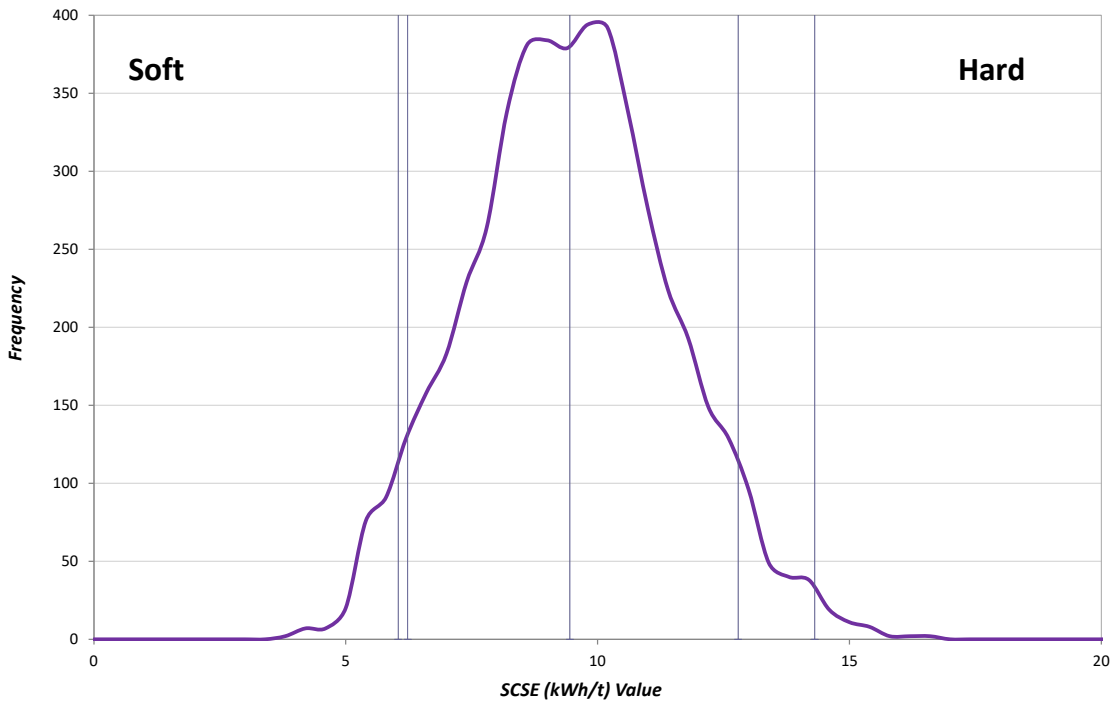

Figure 9 - Frequency Distribution of SCSE in the JKTech Database

4 References

- Andersen, J. and Napier-Munn, T.J., 1988, "Power Prediction for Cone Crushers", Third Mill Operators' Conference, Aus.I.M.M (Cobar, NSW), May 1988, pp 103 - 106
- Bailey, C., *et al*, 2009. "What Can Go Wrong in Comminution Circuit Design?", Proceedings of the Tenth Mill Operators' Conference, (Adelaide, SA), pp. 143–149
- Bond, F.C., 1961. "Crushing and Grinding Calculations Parts I and II", British *Chemical Engineering*, Vol 6, Nos 6 and 8
- Leung, K. 1987. "An Energy-Based Ore Specific Model for Autogenous and Semi-Autogenous Grinding Mills." Ph.D. Thesis. University of Queensland (unpublished)
- Leung, K., Morrison, R.D. and Whiten, W.J., 1987. "An Energy Based Ore Specific Model for Autogenous and Semi-autogenous Grinding", *Copper 87*, Vina del Mar, Vol. 2, pp 71 - 86
- Levin, J., 1989. Observation on the bond standard grindability test, and a proposal for a standard grindability test for fine materials. *SAIMM* 89 (1), 13-21.
- Morrell, S. 1996. "Power Draw of Wet Tumbling Mills and Its Relationship to Charge Dynamics - Parts I and II", *Transaction Inst. Min. Metall.* (Sect C: Mineral Process Extr. Metall.), 105, 1996, pp C43-C62
- Morrell, S., 2004^a. *Predicting the Specific Energy of Autogenous and Semi-autogenous Mills from Small Diameter Drill Core Samples*. *Minerals Engineering*, Vol 17/3 pp 447-451
- Morrell, S., 2004^b. *An Alternative Energy-Size Relationship To That Proposed By Bond For The Design and Optimisation Of Grinding Circuits*. *International Journal of Mineral Processing*, 74, 133-141.
- Morrell, S., 2006. *Rock Characterisation for High Pressure Grinding Rolls Circuit Design*, Proc International Autogenous and Semi Autogenous Grinding Technology, Vancouver, vol IV pp 267-278.
- Morrell, S., 2008, [A method for predicting the specific energy requirement of comminution circuits and assessing their energy utilisation efficiency](#), *Minerals Engineering*, Vol. 21, No. 3.
- Shi, F. and Kojovic, T., 2007. Validation of a model for impact breakage incorporating particle size effect. *Int. Journal of Mineral Processing*, 82, 156-163.
- Veillette, G., and Parker, B., 2005. Boddington Expansion Project Comminution Circuit Features and Testwork, Randol Gold Forum Proceedings.

5 Disclaimer

Warranty by JKTech

- a. JKTech will use its best endeavours to ensure that all documentation, data, recommendations, information, advice and reports ("Material"), provided by JKTech to the client ("Recipient"), is accurate at the time of providing it.

Extent of Warranty by JKTech

- b. JKTech does not make any representations as to any matter, fact or thing that is not expressly provided for in the Material.
- c. JKTech does not give any warranty, nor accept any liability in connection with the Material, except to the extent, if any, required by law or specifically provided in writing by JKTech to the Recipient.
- d. JKTech will not be liable to the Recipient for any claims relating to Material in any language other than in English.
- e. If, apart from this Disclaimer, any warranty would be implied whether by law, custom or otherwise, that warranty is to the full extent permitted by law excluded.
- f. The Recipient will promptly advise JKTech in writing of any losses, damages, compensation, liabilities, amounts, monetary and non-monetary costs and expenses ("Losses"), incurred or likely to be incurred by the Recipient or JKTech in connection with the Material, and any claims, actions, suits, demands or proceedings ("Liabilities") which the Recipient or JKTech may become liable in connection with the Material.

Indemnity and Release by the Recipient

- g. The Recipient indemnifies, releases, discharges and saves harmless, JKTech against any and all Losses and Liabilities, suffered or incurred by JKTech, whether under the law of contract, tort, statutory duty or otherwise as a result of:
 - i) the Recipient relying on the Material;
 - ii) any liability for infringement of a third party's trade secrets, proprietary or confidential information, patents, registered designs, trademarks or names, copyright or other protected rights; and
 - iii) any act or omission of JKTech, any employee, agent or permitted sub-contractor of JKTech in connection with the Material.

Limit of Liability

- h. JKTech's liability to the Recipient in connection with the Material, whether under the law of contract, tort, statutory duty or otherwise, will be limited to the lesser of:
 - i) the total cost of the job; or
 - ii) JKTech providing amended Material rectifying the defect.

Exclusion of Consequential Loss

- i. JKTech is not liable to the Recipient for any consequential, special or indirect loss (loss of revenue, loss of profits, business interruption, loss of opportunity and legal costs and disbursements), in connection with the Material whether under the law of contract, tort, statutory duty or otherwise.

Defects

- j. The Recipient must notify JKTech within seven days of becoming aware of a defect in the Material. To the extent that the defect is caused by JKTech's negligence or breach of contract, JKTech may, at its discretion, rectify the defect.

Duration of Liability

- k. After the expiration of one year from the date of first providing the Material to the client, JKTech will be discharged from all liability in connection with the Material. The Recipient (and persons claiming through or under the Recipient) will not be entitled to commence any action, claim or proceeding of any kind whatsoever after that date, against JKTech (or any employee of JKTech) in connection with the Material.

Contribution

- l. JKTech's liability to the Recipient for any loss or damage, whether under the law of contract, tort, statutory duty or otherwise will be reduced to the extent that an act or omission of the Recipient, its employees or agents, or a third party to whom the Recipient has disclosed the Material, contributed to the loss or damage.

Severability

- m. If any provision of this Disclaimer is illegal, void, invalid or unenforceable for any reason, all other provisions which are self-sustaining and capable of separate enforcement will, to the maximum extent permitted by law, be and continue to be valid and enforceable.

Appendices

APPENDIX A. SAG Circuit Specific Energy (SCSE)

For a little over 20 years, the results of JK Drop Weight tests and SMC tests have been reported in part as A, b and t_a parameters. A and b are parameters which describe the response of the ore under test to increasing levels of input energy in single impact breakage. A typical t_{10} v E_{cs} curve resulting from a Drop Weight test is shown in App Figure 1.

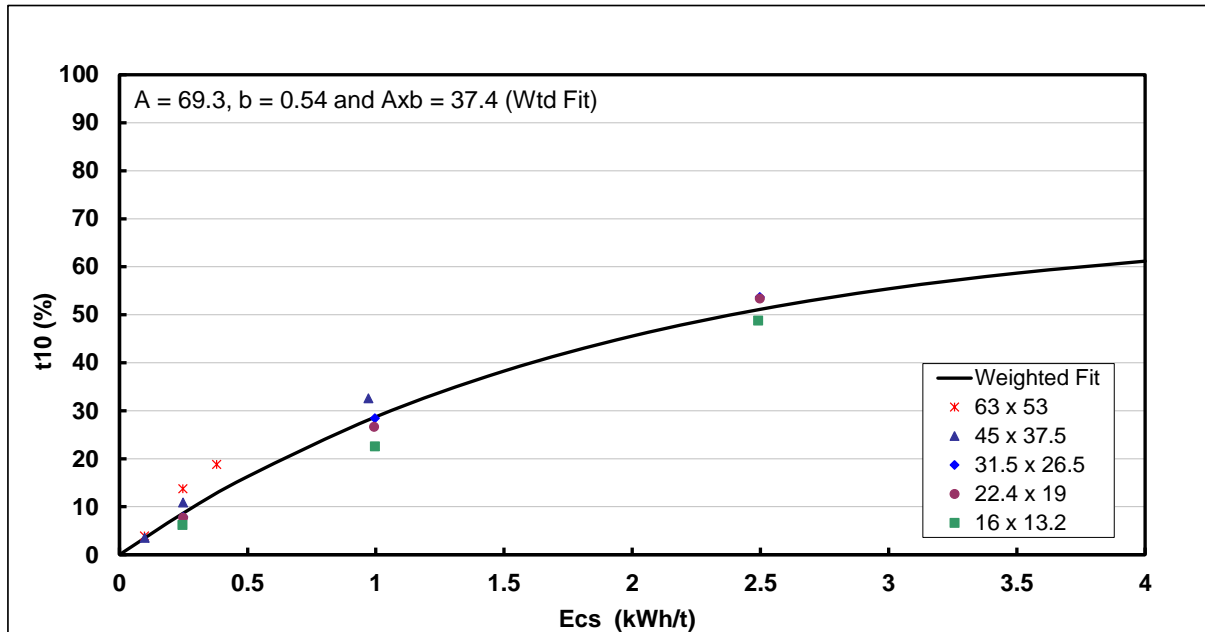

App Figure 1 – Typical t_{10} v E_{cs} curve

The curve shown in App Figure 1 is represented by an equation which is given in Equation 1.

$$t_{10} = A(1 - e^{-b.E_{cs}}) \tag{Equation 1}$$

The parameters A and b are generated by least squares fitting Equation 1 to the JK Drop Weight test data. The parameter t_a is generated from a tumbling test.

Both A and b vary with ore type but having two parameters describing a single ore property makes comparison difficult. For that reason the product of A and b, referred to as $A*b$, which is related to the slope of the $t_{10} - E_{cs}$ curve at the origin, has been universally accepted as the parameter which represents an ore’s resistance to impact breakage.

The parameters A, b and t_a have no physical meaning in their own right. They are ore hardness parameters used by the AG/SAG mill model in JKSimMet which permits prediction of the product size distribution and the power draw of the AG/SAG mill for a given feed size distribution and feed rate. In a design situation, the dimensions of the mill are adjusted until the load in the mill reaches 25 % by volume when fed at the required feed rate. The model predicts the power draw under these conditions and from the power draw and throughput the specific energy is determined. The specific energy is mainly a function of the ore hardness (A and b values), the feed size and the dimensions of the mill (specifically the aspect ratio) as well as to a lesser extent the operating conditions such as ball load, mill speed, grate/pebble port size and pebble crusher activity.

There are two drawbacks to the approach of using $A*b$ as the single parameter to describe the impact resistance of a particular ore. The first is that $A*b$ is inversely related to impact resistance, which adds unnecessary complication. The second is that $A*b$ is related to impact resistance in a non-linear manner. As mentioned earlier this relationship and how it affects comminution machine performance

can only be predicted via simulation modelling. Hence to give more meaning to the A and b values and to overcome these shortcomings, JKTech Pty Ltd and SMC Testing Pty Ltd have developed a “standard” simulation methodology to predict the specific energy required for a particular tested ore when treated in a “Standard” circuit comprising a SAG mill in closed circuit with a pebble crusher. The flowsheet is shown in App Figure 2 .

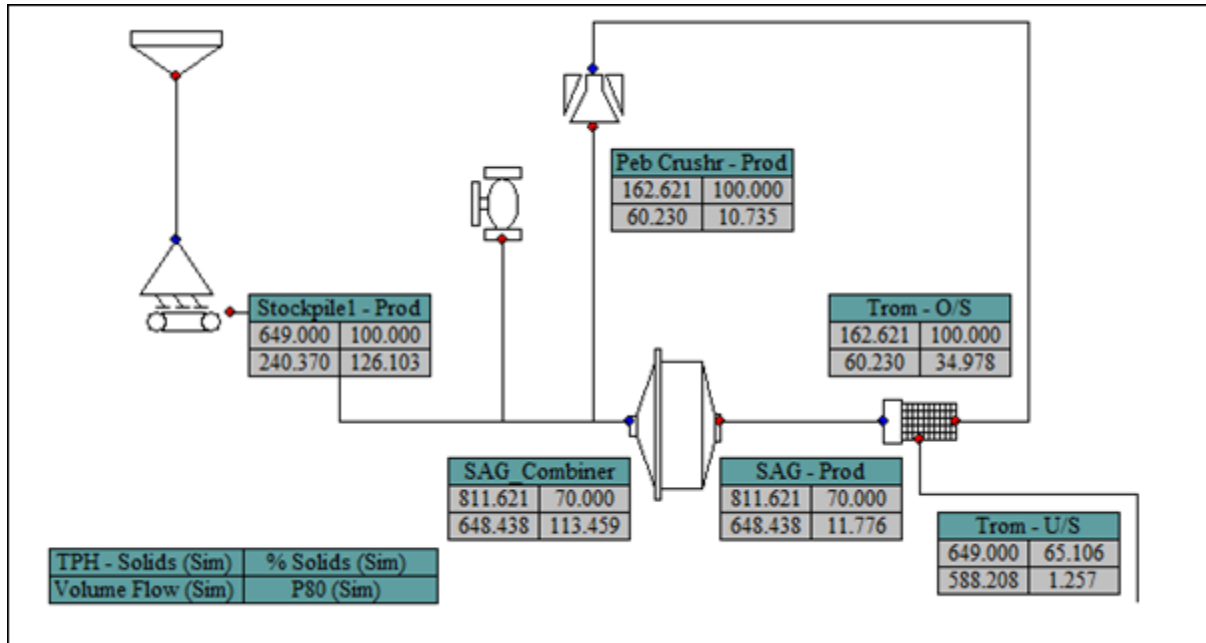

App Figure 2 – Flowsheet used for “Standard” AG/SAG circuit simulations

The specifications for the “standard” circuit are:

- SAG Mill
 - inside shell diameter to length ratio of 2:1 with 15 ° cone angles
 - ball charge of 15 %, 125 mm in diameter
 - total charge of 25 %
 - grate open area of 7 %
 - apertures in the grate are 100 % pebble ports with a nominal aperture of 56 mm
- Trommel
 - Cut Size of 12 mm
- Pebble Crusher
 - Closed Side Setting of 10 mm
- Feed Size Distribution
 - F_{80} from the t_a relationship given in Equation 2

The feed size distribution is taken from the JKTech library of typical feed size distributions and is adjusted to meet the ore specific 80 % passing size predicted using the Morrell and Morrison (1996) $F_{80} - t_a$ relationship for primary crushers with a closed side setting of 150 mm given in Equation 2.

$$F_{80} = 71.3 - 28.4 * \ln(t_a) \quad \text{Equation 2}$$

Simulations were conducted with $A*b$ values ranging from 15 to 400, t_a values ranging from 0.145 to 3.866 and solids SG values ranging from 2.1 to 4.5. For each simulation, the feed rate was adjusted until the total load volume in the SAG mill was 25 %. The predicted mill power draw and crusher power draw were combined and divided by the feed rate to provide the specific energy consumption. The results are shown in App Figure 3.

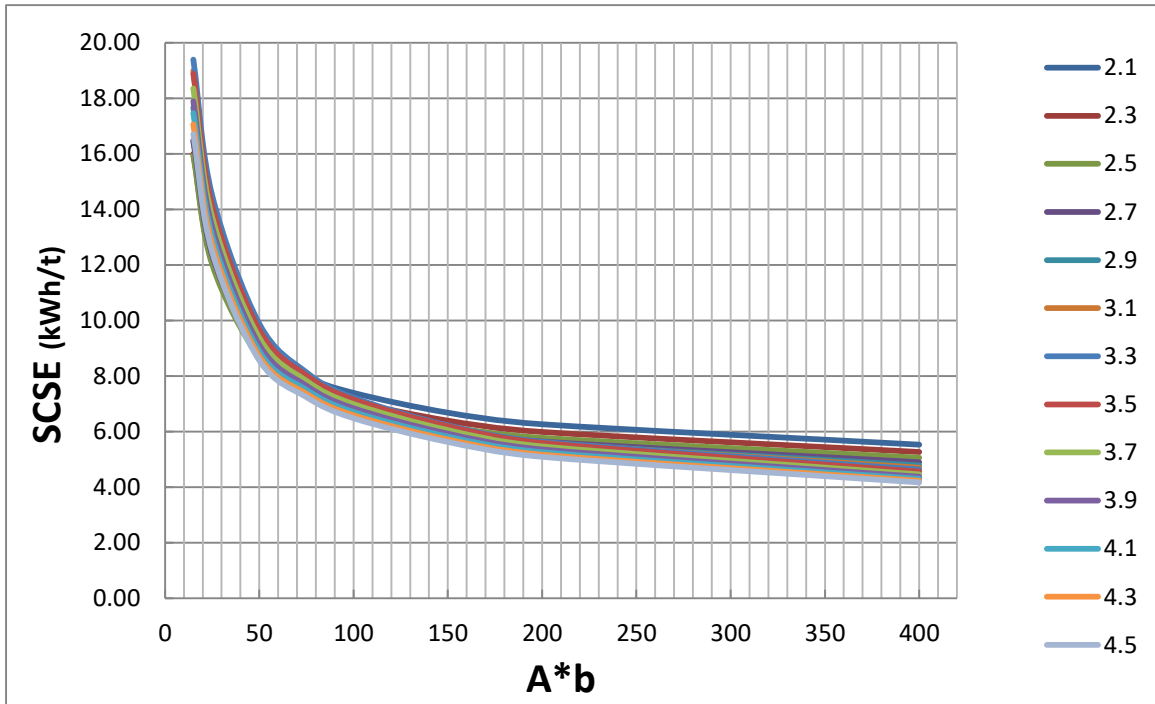

App Figure 3 – The relationship between A*b and specific energy at varying SG for the “Standard” circuit.

It is of note that the family of curves representing the relationship between Specific energy and A*b for the “standard” circuit is very similar to the specific energy – A*b relationship for operating mills published in Veillette and Parker, 2005 and reproduced here in App Figure 4.

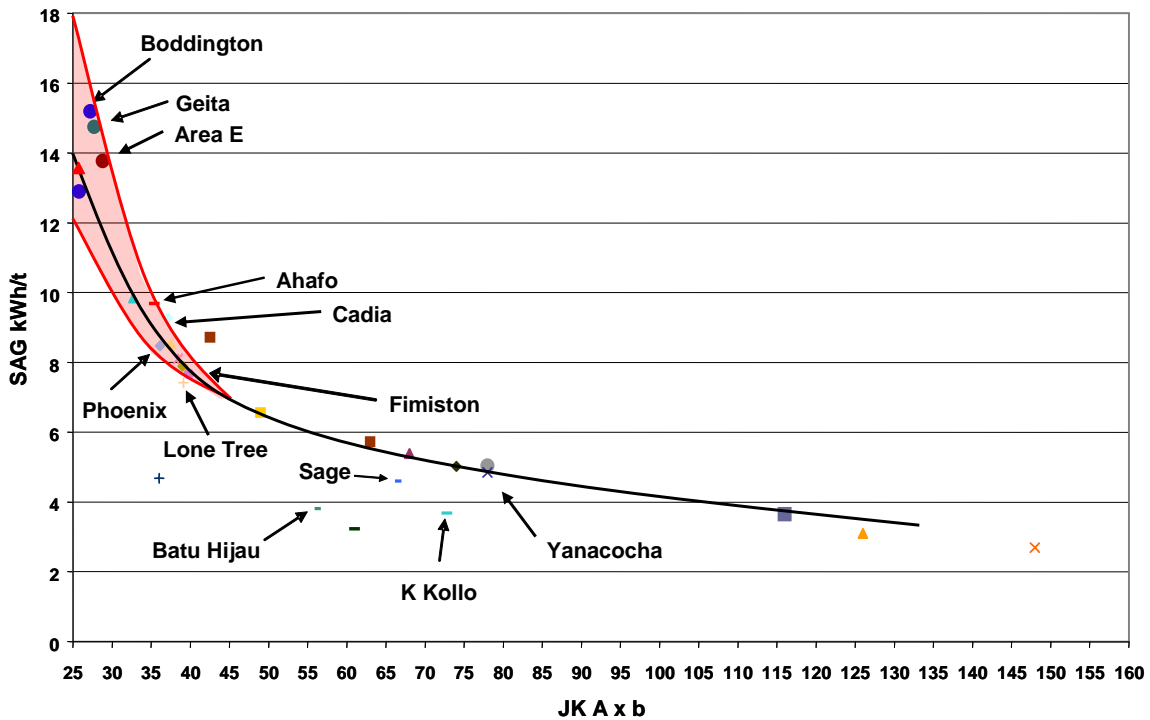

*App Figure 4 – A^*b vs SAG kWh/t for operating AG/SAG mills (after Veillette and Parker, 2005).*

Of course, the SCSE quoted value will not necessarily match the specific energy required for an existing or a planned AG/SAG mill due to differences in the many operating and design variables such as feed size distribution, mill dimensions, ball load and size and grate, trommel and pebble crusher configuration. The SCSE is an effective tool to compare in a relative manner the expected behaviour of different ores in AG/SAG milling in exactly the same way as the Bond laboratory ball mill work index can be used to compare the relative grindability of different ores in ball milling (Bond, 1961 and Rowland and Kjos, 1980). However the originally reported A and b parameters which match the SCSE will be still be required in JKSimMet simulations of a proposed circuit to determine the AG/SAG mill specific energy required for that particular grinding task. Guidelines for the use of JKSimMet for such simulations were given in Bailey *et al*, 2009.

APPENDIX B. Background And Use Of The SMC Test®

B 1 Introduction

The SMC Test® was developed to provide a range of useful comminution parameters through highly controlled breakage of rock samples. Drill core, even quartered small diameter core is suitable. Only relatively small quantities of sample are required and can be re-used to conduct Bond ball work index tests.

The results from conducting the SMC Test® are used to determine the so-called drop-weight index (DW_i), which is a measure of the strength of the rock, as well as the comminution indices M_{ia} , M_{ih} and M_{ic} . The SMC Test® also estimates the JK rock breakage parameters A , b and t_a as well as the JK crusher model's t_{10} - Ecs matrix, all of which are generated as part of the standard report output from the test.

In conjunction with the Bond ball mill work index the DW_i and the M_i suite of parameters can be used to accurately predict the overall specific energy requirements of circuits containing:

- AG and SAG mills.
- Ball mills
- Rod mills
- Crushers
- High Pressure Grinding Rolls (HPGR)

The JK rock breakage parameters can be used to simulate crushing and grinding circuits using JKTech's simulator – JKSimMet.

B 2 Simulation Modelling and Impact Comminution Theory

When a rock fragment is broken, the degree of breakage can be characterised by the " t_{10} " parameter. The t_{10} value is the percentage of the original rock mass that passes a screen aperture one tenth of the original rock fragment size. This parameter allows the degree of breakage to be compared across different starting sizes.

The specific comminution energy (Ecs) has the units kWh/t and is the energy applied during impact breakage. As the impact energy is varied, so does the t_{10} value vary in response. Higher impact energies produce higher values of t_{10} , which of course means products with finer size distributions.

The equation describing the relationship between the t_{10} and Ecs is given below.

$$t_{10} = A(1 - e^{-b.Ecs}) \quad \text{Equation 1}$$

As can be seen from this equation, there are two rock breakage parameters A and b that relate the t_{10} (size distribution index) to the applied specific energy (Ecs). These parameters are ore specific and are normally determined from a full JK Drop-Weight test.

A typical plot of t_{10} vs Ecs from a JK Drop-Weight test is shown in App Figure 5. The relationship is characterised by the two-parameter equation above, where t_{10} is the dependent variable.

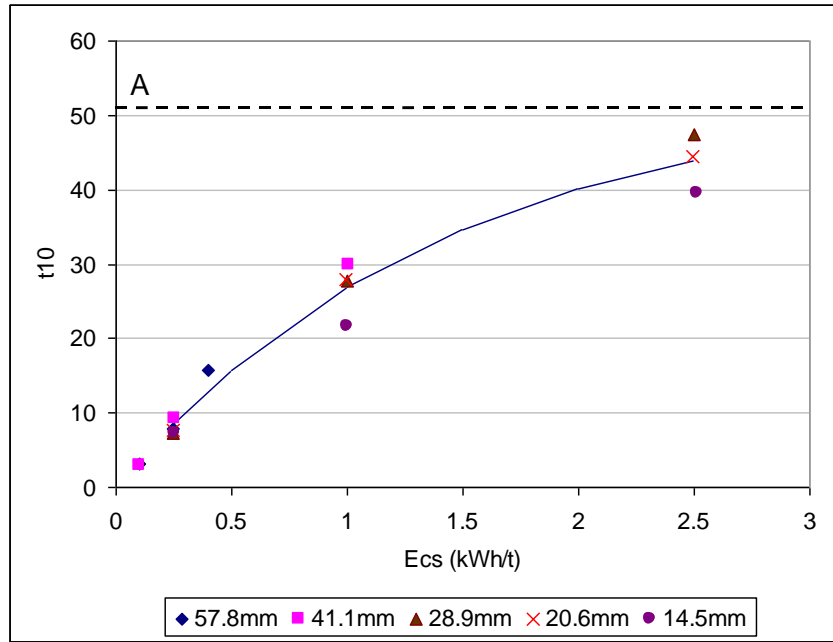

App Figure 5 - Typical t_{10} v Ecs Plot

The t_{10} can be thought of as a “fineness index” with larger values of t_{10} indicating a finer product size distribution. The value of parameter A is the limiting value of t_{10} . This limit indicates that at higher energies, little additional size reduction occurs as the Ecs is increased beyond a certain value. $A*b$ is the slope of the curve at ‘zero’ input energy and is generally regarded as an indication of the strength of the rock, lower values indicating a higher strength.

The SMC Test[®] is used to estimate the JK rock breakage parameters A and b by utilizing the fact that there is usually a pronounced (and ore specific) trend to decreasing rock strength with increasing particle size. This trend is illustrated in App Figure 6 which shows a plot of $A*b$ versus particle size for a number of different rock types.

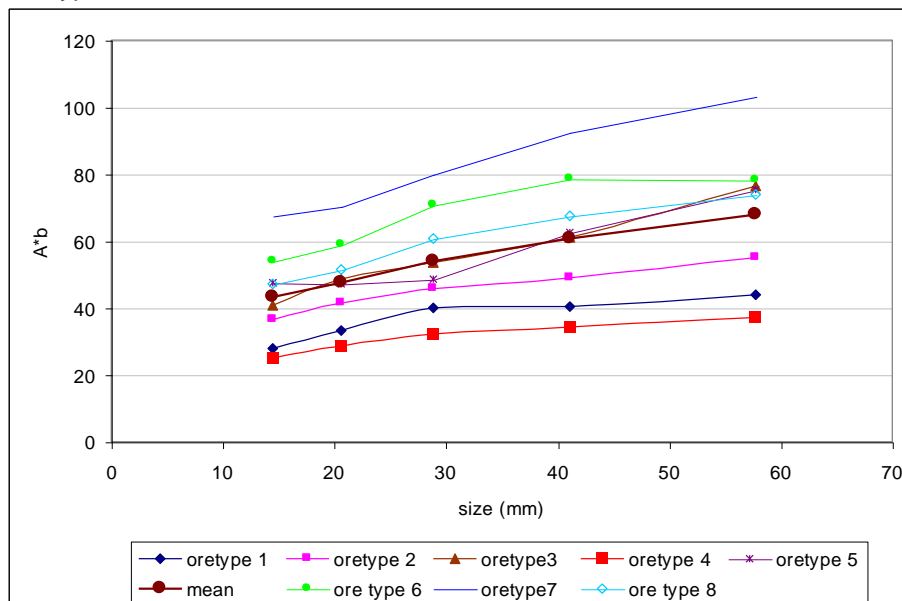

App Figure 6 - Size Dependence of $A*b$ for a Range of Ore Types

In the case of a conventional JK Drop-Weight test these values are effectively averaged and a mean value of A and b is reported. The SMC Test[®] uses a single size and makes use of relationships such as that shown in App Figure 6 to predict the A and b of the particle size that has the same value as the mean for a full JK Drop-Weight test.

An example of this is illustrated in App Figure 7, where the observed values of the product $A*b$ are plotted against those predicted using the DWi. Each of the data points in App Figure 7 is a result from a different ore type within an orebody.

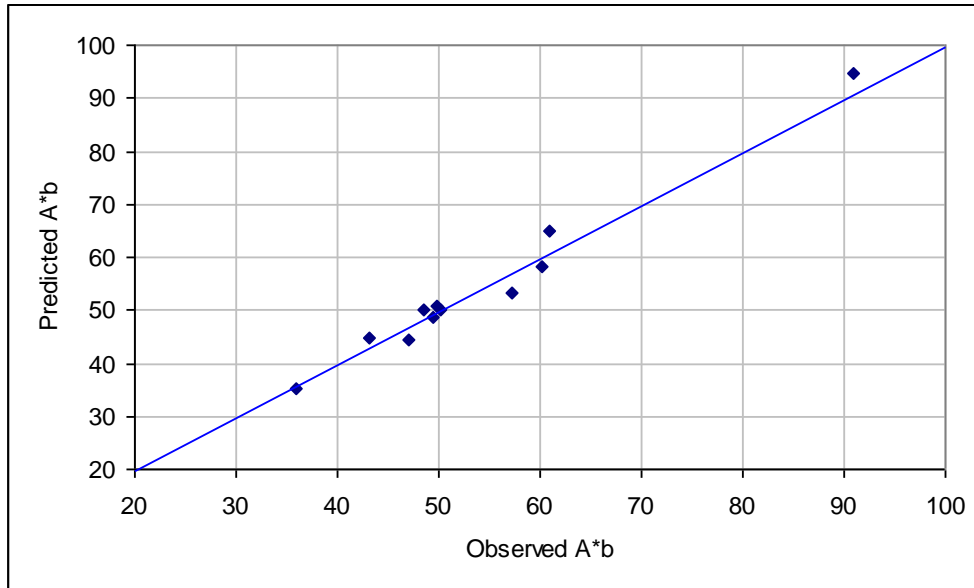

App Figure 7 - Predicted v Observed $A*b$

The A and b parameters are used with Equation 1 and relationships such as illustrated in App Figure 6 to generate a matrix of Ecs values for a specific range of t_{10} values and particle sizes. This matrix is used in crusher modelling to predict the power requirement of the crusher given a feed and a product size specification (Napier-Munn et al (1996)).

The A and b parameters are also used in AG/SAG mill models, such as those in JKSimMet, for predicting how the rock will break inside the mill. From this description the models can predict what the throughput, power draw and product size distribution will be (Napier-Munn et al (1996)). Modelling also enables a detailed flowsheet to be built up of the comminution circuit response to changes in ore type. It also allows optimisation strategies to be developed to overcome any deleterious changes in circuit performance predicted from differences in ore type. These strategies can include both changes to how mills are operated (eg ball load, speed etc) and changes to feed size distribution through modification of blasting practices and primary crusher operation (mine-to-mill).

B 3 Power-Based Equations

B 3.1 General

The DW_i , M_{ia} , M_{in} and M_{ic} parameters are used in so-called power-based equations which predict the specific energy of the associated comminution machines. The approach divides comminution equipment into three categories:

- Tumbling mills, eg AG, SAG, rod and ball mills
- Conventional reciprocating crushers, eg jaw, gyratory and cone
- HPGRs

Tumbling mills are described using 2 indices: M_{ia} and M_{ib}

Crushers have one index: M_{ic}

HPGRs have one index: M_{ih}

For tumbling mills the 2 indices relate to "coarse" and "fine" ore properties plus an efficiency factor which represents the influence of a pebble crusher in AG/SAG mill circuits. "Coarse" in this case is defined as spanning the size range from a P80 of 750 microns up to the P80 of the product of the last stage of crushing or HPGR size reduction prior to grinding. "Fine" covers the size range from a P80 of 750 microns down to P80 sizes typically reached by conventional ball milling, ie about 45 microns. The choice of 750 microns as the division between "coarse" and "fine" particle sizes was determined during the development of the technique and was found to give the best overall results across the range of plants in SMCT's data base. Implicit in the approach is that distributions are parallel and linear in log-log space.

The work index covering grinding in tumbling mills of coarse sizes is labelled M_{ia} . The work index covering grinding of fine particles is labelled M_{ib} (Morrell, 2008). M_{ia} values are provided as a standard output from a SMC Test® (Morrell, 2004a) whilst M_{ib} values can be determined using the data generated by a conventional Bond ball mill work index test (M_{ib} is NOT the Bond ball work index). M_{ic} and M_{ih} values are also provided as a standard output from a SMC Test® (Morrell, 2009).

The general size reduction equation is as follows (Morrell, 2004b):

$$W_i = M_i \cdot 4(x_2^{f(x_2)} - x_1^{f(x_1)}) \quad \text{Equation 3}$$

where

M_i = Work index related to the breakage property of an ore (kWh/tonne); for grinding from the product of the final stage of crushing to a P80 of 750 microns (coarse particles) the index is labelled M_{ia} and for size reduction from 750 microns to the final product P80 normally reached by conventional ball mills (fine particles) it is labelled M_{ib} . For conventional crushing M_{ic} is used and for HPGRs M_{ih} is used.

W_i = Specific comminution (kWh/tonne)

x_2 = 80% passing size for the product (microns)

x_1 = 80% passing size for the feed (microns)

$$f(x_j) = -(0.295 + x_j/1000000) \quad (\text{Morrell, 2006}) \quad \text{Equation 4}$$

For tumbling mills the specific comminution energy (W_i) relates to the power at the pinion or for gearless drives - the motor output. For HPGRs it is the energy inputted to the rolls, whilst for conventional crushers W_i relates to the specific energy as determined using the motor input power less the no-load power.

B 3.2 Specific Energy Determination for Comminution Circuits

The total specific energy (W_T) to reduce primary crusher product to final product size is given by:

$$W_T = W_a + W_b + W_c + W_h + W_s \quad \text{Equation 5}$$

where

W_a = specific energy to grind coarser particles in tumbling mills

W_b = specific energy to grind finer particles in tumbling mills

W_c = specific energy for conventional crushing

W_h = specific energy for HPGRs
 W_s = specific energy correction for size distribution

Clearly only the W values associated with the relevant equipment in the circuit being studied are included in Equation 5.

B 3.2.1 Tumbling mills

For coarse particle grinding in tumbling mills Equation 3 is written as:

$$W_a = K_1 M_{ia} \cdot 4(x_2^{f(x_2)} - x_1^{f(x_1)}) \quad \text{Equation 6}$$

where

K_1 = 1.0 for all circuits that do not contain a recycle pebble crusher and 0.95 where circuits do have a pebble crusher
 x_1 = P₈₀ in microns of the product of the last stage of crushing before grinding
 x_2 = 750 microns
 M_{ia} = Coarse ore work index and is provided directly by SMC Test®

For fine particle grinding Equation 3 is written as:

$$W_b = M_{ib} \cdot 4(x_3^{f(x_3)} - x_2^{f(x_2)}) \quad \text{Equation 7}$$

where

x_2 = 750 microns
 x_3 = P₈₀ of final grind in microns
 M_{ib} = Provided by data from the standard Bond ball work index test using the following equation (Morrell, 2006):

$$M_{ib} = 18.18 / P_1^{0.295} (Gbp)(p_{80}^{f(p_{80})} - f_{80}^{f(f_{80})}) \quad \text{Equation 8}$$

where

M_{ib} = fine ore work index (kWh/tonne)
 P_1 = closing screen size in microns
 Gbp = net grams of screen undersize per mill revolution
 p_{80} = 80% passing size of the product in microns
 f_{80} = 80% passing size of the feed in microns

Note that the Bond ball work index test should be carried out with a closing screen size which gives a final product P80 similar to that intended for the full scale circuit.

B 3.2.2 Conventional Crushers and HPGR

Equation 3 for conventional crushers is written as:

$$W_c = S_c K_2 M_{ic} \cdot 4(x_2^{f(x_2)} - x_1^{f(x_1)}) \quad \text{Equation 9}$$

where

S_c = coarse ore hardness parameter which is used in primary and secondary crushing situations. It is defined by Equation 10 with K_s set to 55.
 K_2 = 1.0 for all crushers operating in closed circuit with a classifying screen. If the crusher is in open circuit, eg pebble crusher in a AG/SAG circuit, K_2 takes the value of 1.19.
 x_1 = P₈₀ in microns of the circuit feed
 x_2 = P₈₀ in microns of the circuit product

M_{ic} = Crushing ore work index and is provided directly by SMC Test®

The coarse ore hardness parameter (S) makes allowance for the decrease in ore hardness that becomes significant in relatively coarse crushing applications such as primary and secondary cone/gyratory circuits. In tertiary and pebble crushing circuits it is normally not necessary and takes the value of unity. In full scale HPGR circuits where feed sizes tend to be higher than used in laboratory and pilot scale machines the parameter has also been found to improve predictive accuracy. The parameter is defined by Equation 10.

$$S = K_s(x_1 \cdot x_2)^{-0.2} \quad \text{Equation 10}$$

where

K_s = machine-specific constant that takes the value of 55 for conventional crushers and 35 in the case of HPGRs

x_1 = P₈₀ in microns of the circuit feed

x_2 = P₈₀ in microns of the circuit product

Equation 3 for HPGR's crushers is written as:

$$W_h = S_h K_3 M_{ih} \cdot 4(x_2^{f(x_2)} - x_1^{f(x_1)}) \quad \text{Equation 11}$$

where

S_h = coarse ore harness parameter as defined by Equation 10 and with K_s set to 35

K_3 = 1.0 for all HPGRs operating in closed circuit with a classifying screen. If the HPGR is in open circuit, K_3 takes the value of 1.19.

x_1 = P₈₀ in microns of the circuit feed

x_2 = P₈₀ in microns of the circuit product

M_{ih} = HPGR ore work index and is provided directly by SMC Test®

B 3.2.3 Specific Energy Correction for Size Distribution (Ws)

Implicit in the approach described in this appendix is that the feed and product size distributions are parallel and linear in log-log space. Where they are not, allowances (corrections) need to be made. By and large, such corrections are most likely to be necessary (or are large enough to be warranted) when evaluating circuits in which closed circuit secondary/tertiary crushing is followed by ball milling. This is because such crushing circuits tend to produce a product size distribution which is relatively steep when compared to the ball mill circuit cyclone overflow. This is illustrated in App Figure 8, which shows measured distributions from an open and closed crusher circuit as well as a ball mill cyclone overflow. The closed circuit crusher distribution can be seen to be relatively steep compared with the open circuit crusher distribution and ball mill cyclone overflow. Also the open circuit distribution more closely follows the gradient of the cyclone overflow. If a ball mill circuit were to be fed two distributions, each with same P80 but with the open and closed circuit gradients in App Figure 8, the closed circuit distribution would require more energy to grind to the final P80. How much more energy is required is difficult to determine. However, for the purposes of this approach it has been assumed that the additional specific energy for ball milling is the same as the difference in specific energy between open and closed crushing to reach the nominated ball mill feed size. This assumes that a crusher would provide this energy. However, in this situation the ball mill has to supply this energy and it has a different (higher) work index than the crusher (ie the ball mill is less energy efficient than a crusher and has to input more energy to do the same amount of size reduction). Hence from Equation 9, to crush to the ball mill circuit feed size (x_2) in open circuit requires specific energy equivalent to:

$$W_c = 1.19 * M_{ic} \cdot 4(x_2^{f(x_2)} - x_1^{f(x_1)}) \quad \text{Equation 12}$$

For closed circuit crushing the specific energy is:

$$W_c = 1 * M_{ic} \cdot 4(x_2^{f(x_2)} - x_1^{f(x_1)}) \tag{Equation 13}$$

The difference between the two (Equation 12 and Equation 13) has to be provided by the milling circuit with an allowance for the fact that the ball mill, with its lower energy efficiency, has to provide it and not the crusher. This is what is referred to in Equation 5 as W_s and for the above example is therefore represented by:

$$W_s = 0.19 * M_{ia} \cdot 4(x_2^{f(x_2)} - x_1^{f(x_1)}) \tag{Equation 14}$$

Note that in Equation 14 M_{ic} has been replaced with M_{ia} , the coarse particle tumbling mill grinding work index.

In AG/SAG based circuits the need for W_s appears to be unnecessary as App Figure 9 illustrates. Primary crusher feeds often have the shape shown in App Figure 9 and this has a very similar gradient to typical ball mill cyclone overflows. A similar situation appears to apply with HPGR product size distributions, as illustrated in App Figure 10. Interestingly SMCT's data show that for HPGRs, closed circuit operation appears to require a lower specific energy to reach the same P80 as in open circuit, even though the distributions for open and closed circuit look to have almost identical gradients. Closer examination of the distributions in fact shows that in closed circuit the final product tends to have slightly less very fine material, which may account for the different energy requirements between the two modes of operation. It is also possible that recycled material in closed circuit is inherently weaker than new feed, as it has already passed through the HPGR previously and may have sustained micro-cracking. A reduction in the Bond ball mill work index as measured by testing HPGR products compared it to the Bond ball mill work index of HPGR feed has been noticed in many cases in the laboratory (see next section) and hence there is no reason to expect the same phenomenon would not affect the recycled HPGR screen oversize.

It follows from the above arguments that in HPGR circuits, which are typically fed with material from closed circuit secondary crushers, a similar feed size distribution correction should also be applied. However, as the secondary crushing circuit uses such a relatively small amount of energy compared to the rest of the circuit (as it crushes to a relatively coarse size) the magnitude of size distribution correction is very small indeed – much smaller than the error associated with the technique - and hence may be omitted in calculations.

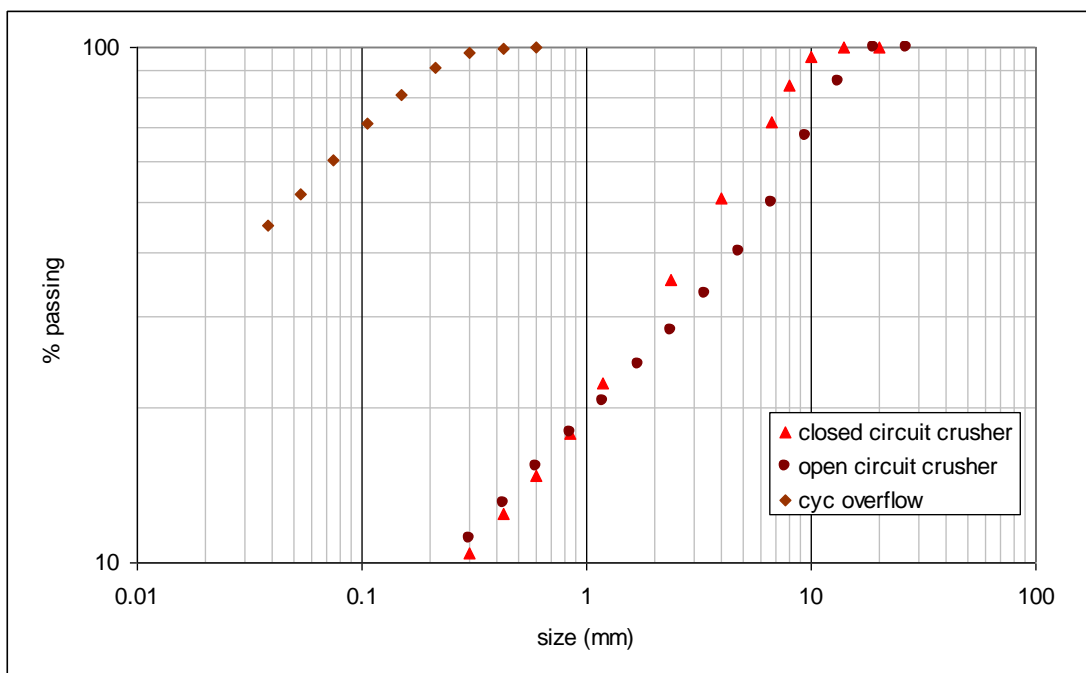

App Figure 8 – Examples of Open and Closed Circuit Crushing Distributions Compared with a Typical Ball Mill Cyclone Overflow Distribution

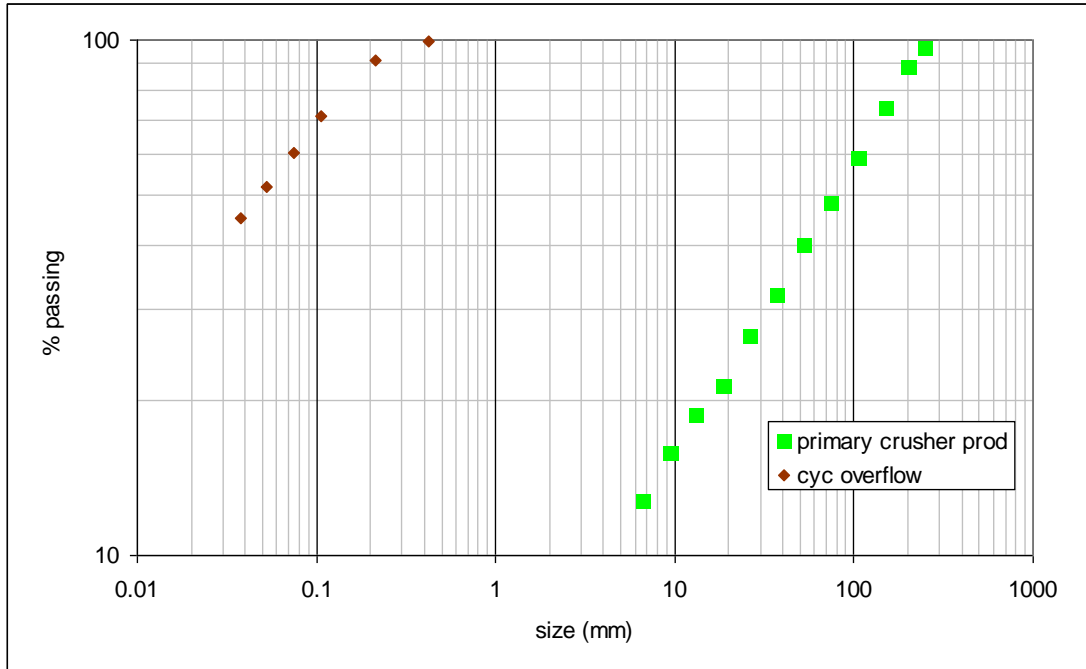

App Figure 9 – Example of a Typical Primary Crusher (Open and Circuit) Product Distribution Compared with a Typical Ball Mill Cyclone Overflow Distribution

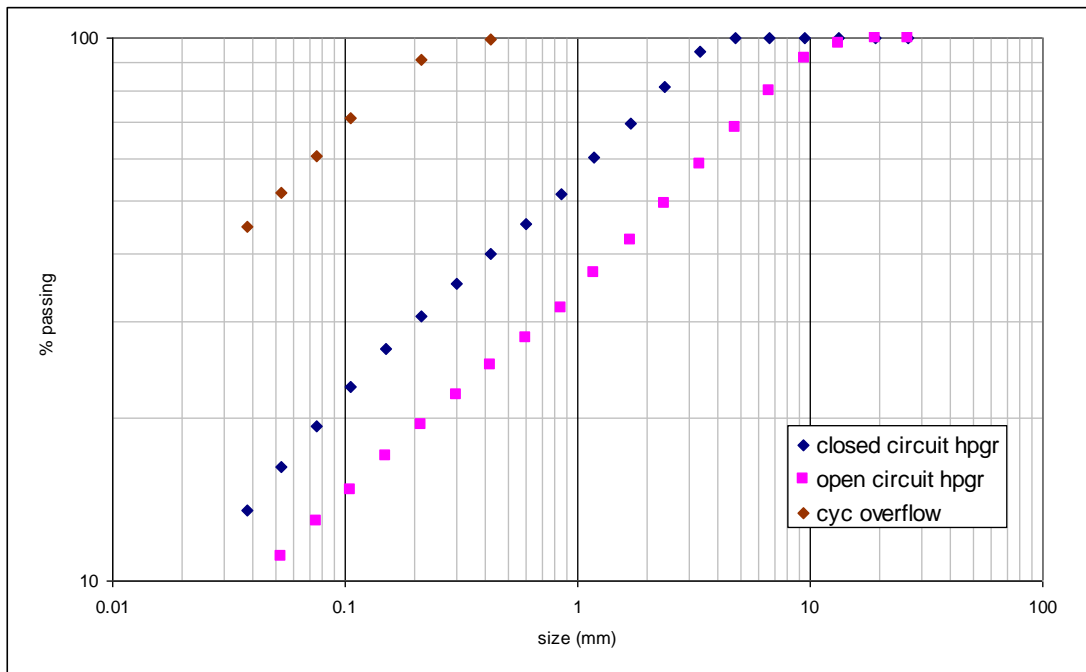

App Figure 10 – Examples of Open and Closed Circuit HPGR Distributions Compared with a Typical Ball Mill Cyclone Overflow Distribution

B 3.2.4 Weakening of HPGR Products

As mentioned in the previous section, laboratory experiments have been reported by various researchers in which the Bond ball work index of HPGR products is less than that of the feed. The amount of this reduction appears to vary with both material type and the pressing force used. Observed reductions in the Bond ball work index have typically been in the range 0-10%. In the approach described in this appendix no allowance has been made for such weakening. However, if HPGR products are available which can be used to conduct Bond ball work index tests on then M_{ib} values obtained from such tests can be used in Equation 7. Alternatively the M_{ib} values from Bond ball mill work index tests on HPGR feed material can be reduced by an amount that the user thinks is appropriate. Until more data become available from full scale HPGR/ball mill circuits it is suggested that, in the absence of Bond ball mill work index data on HPGR products, the M_{ib} results from HPGR feed material are reduced by no more than 5% to allow for the effects of micro-cracking.

B 3.3 Validation

B 3.3.1 Tumbling Mill Circuits

The approach described in the previous section was applied to over 120 industrial data sets. The results are shown in App Figure 11. In all cases, the specific energy relates to the tumbling mills contributing to size reduction from the product of the final stage of crushing to the final grind. Data are presented in terms of equivalent specific energy at the pinion. In determining what these values were on each of the plants in the data base it was assumed that power at the pinion was 93.5% of the measured gross (motor input) power, this figure being typical of what is normally accepted as being reasonable to represent losses across the motor and gearbox. For gearless drives (so-called wrap-around motors) a figure of 97% was used.

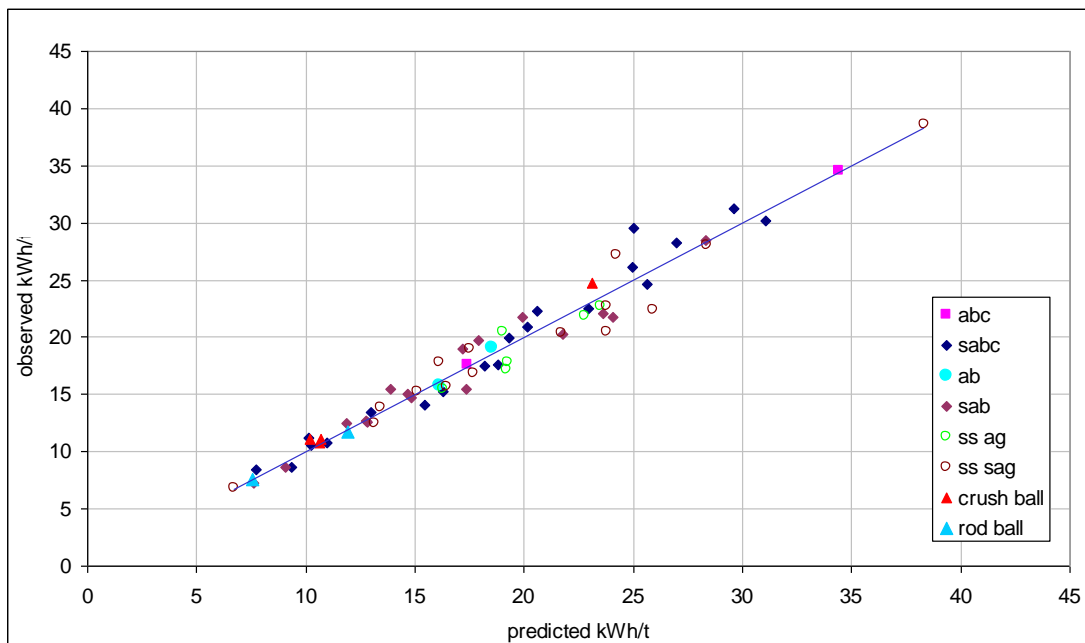

App Figure 11 – Observed vs Predicted Tumbling Mill Specific Energy

B 3.3.2 Conventional Crushers

Validation used 12 different crushing circuits (25 data sets), including secondary, tertiary and pebble crushers in AG/SAG circuits. Observed vs predicted specific energies are given in App Figure 12. The observed specific energies were calculated from the crusher throughput and the net power draw of the crusher as defined by:

$$\text{Net Power} = \text{Motor Input Power} - \text{No Load Power} \quad \text{Equation 15}$$

No-load power tends to be relatively high in conventional crushers and hence net power is significantly lower than the motor input power. From examination of the 25 crusher data sets the motor input power was found to be on average 20% higher than the net power.

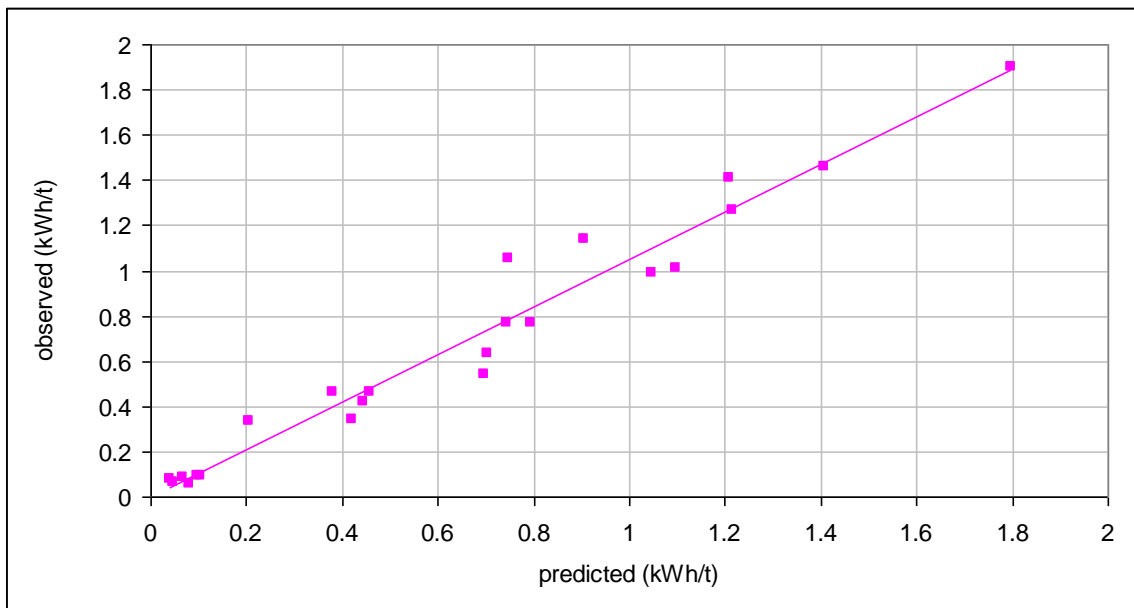

App Figure 12 – Observed vs Predicted Conventional Crusher Specific Energy

B 3.3.3 HPGRs

Validation for HPGRs used data from 19 different circuits (36 data sets) including laboratory, pilot and industrial scale equipment. Observed vs predicted specific energies are given in App Figure 13. The data relate to HPGRs operating with specific grinding forces typically in the range 2.5-3.5 N/mm². The observed specific energies relate to power delivered by the roll drive shafts. Motor input power for full scale machines is expected to be 8-10% higher.

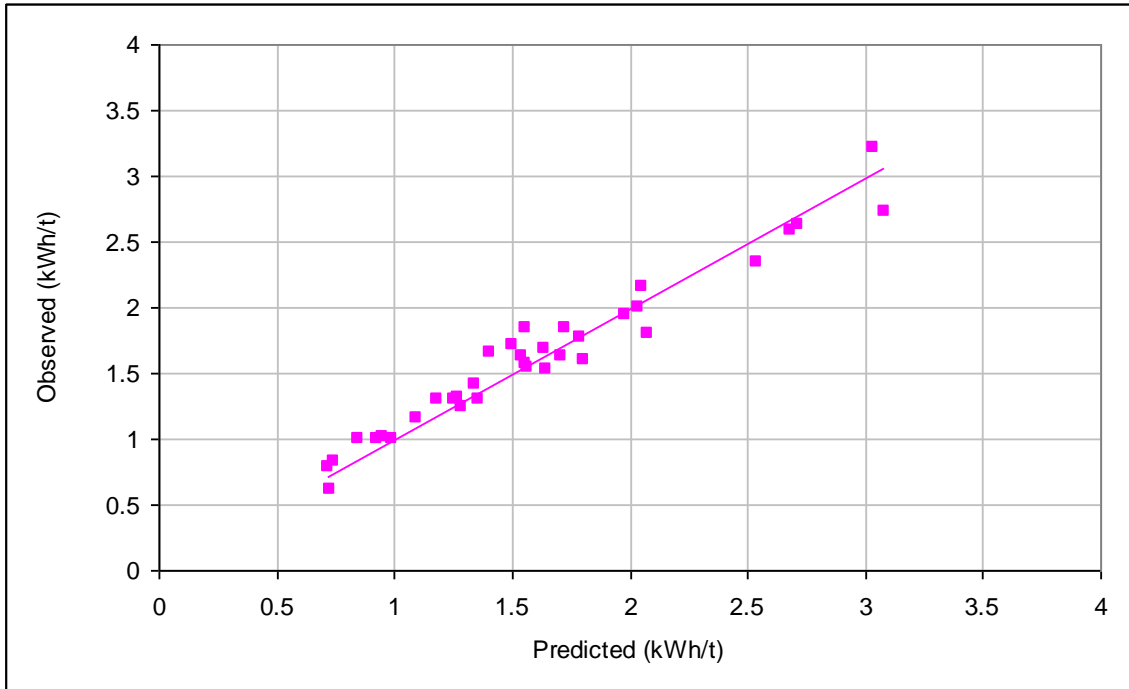

App Figure 13 – Observed vs Predicted HPGR Specific Energy

B 4 WORKED EXAMPLES

A SMC Test[®] and Bond ball work index test were carried out on a representative ore sample. The following results were obtained:

SMC Test[®]:

M_{ia} = 19.4 kWh/t

M_{ic} = 7.2 kWh/t

M_{ih} = 13.9 kWh/t

Bond test carried out with a 150 micron closing screen:

M_{ib} = 18.8 kWh/t

Three circuits are to be evaluated:

- SABC
- HPGR/ball mill
- Conventional crushing/ball mill

The overall specific grinding energy to reduce a primary crusher product with a P_{80} of 100 mm to a final product P_{80} of 106 μ m needs to be estimated.

B 4.1 SABC Circuit

Coarse particle tumbling mill specific energy:

$$W_a = 0.95 * 19.4 * 4 * \left(750^{-0.295+750/1000000} - 100000^{-0.295+100000/1000000} \right)$$

$$= 9.6 \text{ kWh/t}$$

Fine particle tumbling mill specific energy:

$$W_b = 18.8 * 4 * \left(106^{-0.295+106/1000000} - 750^{-0.295+750/1000000} \right)$$

$$= 8.4 \text{ kWh/t}$$

Pebble crusher specific energy:

In this circuit, it is assumed that the pebble crusher feed P_{80} is 52.5mm. As a rule of thumb this value can be estimated by assuming that it is 0.75 of the nominal pebble port aperture (in this case the pebble port aperture is 70mm). The pebble crusher is set to give a product P_{80} of 12mm. The pebble crusher feed rate is expected to be 25% of new feed tph.

$$W_c = 1.19 * 7.2 * 4 * \left(12000^{-0.295+12000/1000000} - 52500^{-0.295+52500/1000000} \right)$$

$$= 1.12 \text{ kWh/t when expressed in terms of the crusher feed rate}$$

$$= 1.12 * 0.25 \text{ kWh/t when expressed in terms of the SABC circuit new feed rate}$$

$$= 0.3 \text{ kWh/t of SAG mill circuit new feed}$$

Total net comminution specific energy:

$$W_T = 9.6 + 8.4 + 0.3 \text{ kWh/t}$$

$$= 18.3 \text{ kWh/t}$$

B 4.2 HPGR/Ball Milling Circuit

In this circuit primary crusher product is reduced to a HPGR circuit feed P_{80} of 35 mm by closed circuit secondary crushing. The HPGR is also in closed circuit and reduces the 35 mm feed to a circuit product P_{80} of 4 mm. This is then fed to a closed circuit ball mill which takes the grind down to a P_{80} of 106 μm .

Secondary crushing specific energy:

$$W_c = 1 * 55 * (35000 * 100000)^{-0.2} * 7.2 * 4 * \left(35000^{-0.295+35000/1000000} - 100000^{-0.295+100000/1000000} \right)$$

$$= 0.4 \text{ kWh/t}$$

HPGR specific energy:

$$W_h = 1 * 35 * (4000 * 35000)^{-0.2} * 13.9 * 4 * \left(4000^{-0.295+4000/1000000} - 35000^{-0.295+35000/1000000} \right)$$

$$= 2.4 \text{ kWh/t}$$

Coarse particle tumbling mill specific energy:

$$W_a = 1 * 19.4 * 4 * \left(750^{-0.295+750/1000000} - 4000^{-0.295+4000/1000000} \right)$$

$$= 4.5 \text{ kWh/t}$$

Fine particle tumbling mill specific energy:

$$W_b = 18.8 * 4 * \left(106^{-0.295+106/1000000} - 750^{-0.295+750/1000000} \right)$$

$$= 8.4 \text{ kWh/t}$$

Total net comminution specific energy:

$$\begin{aligned} W_T &= 4.5 + 8.4 + 0.4 + 2.4 \quad \text{kWh/t} \\ &= 15.7 \text{ kWh/t} \end{aligned}$$

B 4.3 Conventional Crushing/Ball Milling Circuit

In this circuit primary crusher product is reduced in size to P₈₀ of 6.5 mm via a secondary/tertiary crushing circuit (closed). This is then fed to a closed circuit ball mill which grinds to a P₈₀ of 106 µm.

Secondary/tertiary crushing specific energy:

$$\begin{aligned} W_c &= 1 * 7.2 * 4 * \left(6500^{-0.295+6500/1000000} - 100000^{-0.295+100000/1000000} \right) \\ &= 1.7 \text{ kWh/t} \end{aligned}$$

Coarse particle tumbling mill specific energy :

$$\begin{aligned} W_a &= 1 * 19.4 * 4 * \left(750^{-0.295+750/1000000} - 6500^{-0.295+6500/1000000} \right) \\ &= 5.5 \text{ kWh/t} \end{aligned}$$

Fine particle tumbling mill specific energy:

$$\begin{aligned} W_b &= 18.8 * 4 * \left(106^{-0.295+106/1000000} - 750^{-0.295+750/1000000} \right) \\ &= 8.4 \text{ kWh/t} \end{aligned}$$

Size distribution correction;

$$\begin{aligned} W_s &= 0.19 * 19.4 * 4 * \left(6500^{-0.295+6500/1000000} - 100000^{-0.295+100000/1000000} \right) \\ &= 0.9 \text{ kWh/t} \end{aligned}$$

Total net comminution specific energy:

$$\begin{aligned} W_T &= 5.5 + 8.4 + 1.7 + 0.9 \quad \text{kWh/t} \\ &= 16.5 \text{ kWh/t} \end{aligned}$$

SMC Test - Test Definition Sheet			Version 2016 03 09										
Client:	North American Nickel		ERASE ALL DATA ENTRY FIELDS	Target Particle Sizes									
SGS Project Name or Number:	18559-01			Nominal Core Diam. (mm)	Target		1/4 Core Length (mm)	Tolerance (mm)	Screen Aperture (mm)	Core Diameter Range		Core Volume Range	
Client Sample Identification:	SN COMP				Volume cu. cm	Mass (g)				Minimum (mm)	Maximum (mm)	Minimum (cu. cm)	Maximum (cu. cm)
Deposit / Sample Source:	Phikwe Selebi			36.3	2.1	7.8	8.1	1	1.41	32.3	39.4	1.38	2.83
Operator:	SR			41.9	3.6	13.3	10.3	1.5	1.68	39.5	45.4	2.83	4.78
Test Date: ('dd/mm/yyyy')	5 July 2021	Machine ID:		48.4	6.0	22.4	13.1	1.5	2	45.5	52.7	4.78	8.18
SGS Sample Number:			56.2	10.4	38.6	16.7	2	2.4	52.8	60.3	8.18	13.42	
Results for Test #	Eis (kWh/t)	t10	Mean Mass (g)	63.8	16.5	61.4	20.6	2	2.8	60.4	69.4	13.42	22.33
1	0.251	28.008	60.740	73.9	28.2	105.1	26.3	2.5	3.35	69.5	79.9	22.33	37.39
2	0.504	48.352	60.875	84.8	46.6	173.6	32.9	3	3.96	80.0	89.1	37.39	55.76
3	1.010	64.033	60.625	* For cores of less than 32 mm diameter, please refer to JKTech for recommendations.									
4	1.618	74.861	60.635	Click on this button to go to the Pre Start Check List. Print this out and complete it before you begin drop-testing.									
5	2.218	76.009	60.635										
Mean SG	3.727	Click on this button if you wish to see the full SMC test procedure. This is now available via the internet.											
Test Laboratory:	SGS Lakefield												
Language:	English		Note: If the test is to be carried out on broken rock pieces, the largest screen size range possible should be selected, given the top size of the sample you are dealing with and the quantity available. If you have doubts about there being sufficient material to yield 100 particles from the selected size range, then you should switch to using the next lower size range.										
Starting Material is:	Broken Rock												
Tests to be carried out on:	Broken Rock		Step 1: There are two methods that can be used in the SMC test to generate the particles for breakage testing. The particles can either be cut pieces of quartered core or crushed pieces of either rock or core. The two methods are considered to be of equal accuracy, so which one is used is a matter of preference. The crush and particle select method is probably faster, so may be the preferred method when there is plenty of sample. To use this method you normally need about 20 kg, which is generally more than required for the cut core method, except when you are dealing with the largest diameter cores. When using the crush and particle select method, you should set the "Tests to be carried out on:" drop-down to "Broken Rock" and then select a size range from the "Select screen size to be targeted:" drop-down. The ideal size range if there is plenty of material available is the largest (ie. -31.5+26.5 mm). However, the test is most commonly carried out on -22.4+19 mm material and this is quite acceptable also. If sample quantity is very limited you may need to select the finest size range (-16+13.2 mm). Although the results are still acceptable, the test accuracy will not be quite as good using this size range, so it should only be used as a last resort when there is not enough sample to complete the test on a coarser size fraction.										
Select screen size range to be targeted: <small>(Select coarsest screen size possible, given the sample top size and amount available.)</small>	-31.5+26.5 mm												
Corresponding Nominal Core Diameter Targeted:	63.8 mm												
Estimate of Density for Sample Requirements:	2.7												
Approximate Length of Starting Material Required:	Not Applicable												

SMC Test - Test Definition Sheet			Version 2016 03 09											
Client:	North American Nickel		ERASE ALL DATA ENTRY FIELDS	Target Particle Sizes										
SGS Project Name or Number:	18559-01			Nominal Core Diam. (mm)	Target		1/4 Core Length (mm)	Tolerance (mm)	Screen Aperture (mm)	Core Diameter Range		Core Volume Range		
Client Sample Identification:	S COMP				Volume cu. cm	Mass (g)				Minimum (mm)	Maximum (mm)	Minimum (cu. cm)	Maximum (cu. cm)	
Deposit / Sample Source:	Phikwe Selebi			36.3	2.1	7.3	8.1	1	1.41	32.3	39.4	1.38	2.83	
Operator:	SR			41.9	3.6	12.4	10.3	1.5	1.68	39.5	45.4	2.83	4.78	
Test Date: ('dd/mm/yyyy')	5 July 2021	Machine ID:		48.4	6.0	20.9	13.1	1.5	2	45.5	52.7	4.78	8.18	
SGS Sample Number:				56.2	10.4	36.1	16.7	2	2.4	52.8	60.3	8.18	13.42	
Results for Test #	Eis (kWh/t)	t10		Mean Mass (g)	63.8	16.5	57.4	20.6	2	2.8	60.4	69.4	13.42	22.33
1	0.251	30.802		55.710	73.9	28.2	98.3	26.3	2.5	3.35	69.5	79.9	22.33	37.39
2	0.503	42.069		55.740	84.8	46.6	162.3	32.9	3	3.96	80.0	89.1	37.39	55.76
3	1.009	65.024	55.695	* For cores of less than 32 mm diameter, please refer to JKTech for recommendations.										
4	1.718	68.911	55.555	Click on this button to go to the Pre Start Check List. Print this out and complete it before you begin drop-testing.										
5	2.416	75.952	55.630											
Mean SG	3.485	Click on this button if you wish to see the full SMC test procedure. This is now available via the internet.												
Test Laboratory:	SGS Lakefield													
Language:	English		Note: If the test is to be carried out on broken rock pieces, the largest screen size range possible should be selected, given the top size of the sample you are dealing with and the quantity available. If you have doubts about there being sufficient material to yield 100 particles from the selected size range, then you should switch to using the next lower size range.											
Starting Material is:	Broken Rock		Step 1: There are two methods that can be used in the SMC test to generate the particles for breakage testing. The particles can either be cut pieces of quartered core or crushed pieces of either rock or core. The two methods are considered to be of equal accuracy, so which one is used is a matter of preference. The crush and particle select method is probably faster, so may be the preferred method when there is plenty of sample. To use this method you normally need about 20 kg, which is generally more than required for the cut core method, except when you are dealing with the largest diameter cores.											
Tests to be carried out on:	Broken Rock													
Select screen size range to be targeted: <small>(Select coarsest screen size possible, given the sample top size and amount available.)</small>	-31.5+26.5 mm		When using the crush and particle select method, you should set the "Tests to be carried out on:" drop-down to "Broken Rock" and then select a size range from the "Select screen size to be targeted" drop-down. The ideal size range if there is plenty of material available is the largest (ie. -31.5+26.5 mm). However, the test is most commonly carried out on -22.4+19 mm material and this is quite acceptable also. If sample quantity is very limited you may need to select the finest size range (-16+13.2 mm). Although the results are still acceptable, the test accuracy will not be quite as good using this size range, so it should only be used as a last resort when there is not enough sample to complete the test on a coarser size fraction.											
Corresponding Nominal Core Diameter Targeted:	63.8 mm													
Estimate of Density for Sample Requirements:	2.7													
Approximate Length of Starting Material Required:	Not Applicable													

SMC Test - Test Definition Sheet			Version 2016 03 09																																																																																																	
Client:	North American Nickel			ERASE ALL DATA ENTRY FIELDS																																																																																																
SGS Project Name or Number:	18559-01																																																																																																			
Client Sample Identification:	P COMP																																																																																																			
Deposit / Sample Source:	Phikwe Selebi																																																																																																			
Operator:	SR																																																																																																			
Test Date: ('dd/mm/yyyy')	5 July 2021	Machine ID:																																																																																																		
SGS Sample Number:																																																																																																				
Results for Test #	Eis (kWh/t)	t10	Mean Mass (g)																																																																																																	
1	0.250	11.900	52.185																																																																																																	
2	0.500	22.092	52.190																																																																																																	
3	1.003	35.812	52.195																																																																																																	
4	1.784	51.987	52.105																																																																																																	
5	2.567	58.161	52.250																																																																																																	
Mean SG	3.130																																																																																																			
Test Laboratory:	SGS Lakefield																																																																																																			
Language:	English																																																																																																			
Starting Material is:	Broken Rock																																																																																																			
Tests to be carried out on:	Broken Rock																																																																																																			
Select screen size range to be targeted: <small>(Select coarsest screen size possible, given the sample top size and amount available.)</small>	-31.5+26.5 mm																																																																																																			
Corresponding Nominal Core Diameter Targeted:	63.8 mm																																																																																																			
Estimate of Density for Sample Requirements:	2.7																																																																																																			
Approximate Length of Starting Material Required:	Not Applicable																																																																																																			
<table border="1" style="width: 100%; border-collapse: collapse;"> <thead> <tr> <th colspan="10">Target Particle Sizes</th> </tr> <tr> <th rowspan="2">Nominal Core Diam. (mm)</th> <th colspan="2">Target</th> <th rowspan="2">1/4 Core Length (mm)</th> <th rowspan="2">Tolerance (mm)</th> <th rowspan="2">Screen Aperture (mm)</th> <th colspan="2">Core Diameter Range</th> <th colspan="2">Core Volume Range</th> </tr> <tr> <th>Volume cu. cm</th> <th>Mass (g)</th> <th>Minimum (mm)</th> <th>Maximum (mm)</th> <th>Minimum (cu. cm)</th> <th>Maximum (cu. cm)</th> </tr> </thead> <tbody> <tr> <td>36.3</td> <td>2.1</td> <td>6.6</td> <td>8.1</td> <td>1</td> <td>1.41</td> <td>32.3</td> <td>39.4</td> <td>1.38</td> <td>2.83</td> </tr> <tr> <td>41.9</td> <td>3.6</td> <td>11.1</td> <td>10.3</td> <td>1.5</td> <td>1.68</td> <td>39.5</td> <td>45.4</td> <td>2.83</td> <td>4.78</td> </tr> <tr> <td>48.4</td> <td>6.0</td> <td>18.8</td> <td>13.1</td> <td>1.5</td> <td>2</td> <td>45.5</td> <td>52.7</td> <td>4.78</td> <td>8.18</td> </tr> <tr> <td>56.2</td> <td>10.4</td> <td>32.5</td> <td>16.7</td> <td>2</td> <td>2.4</td> <td>52.8</td> <td>60.3</td> <td>8.18</td> <td>13.42</td> </tr> <tr> <td>63.8</td> <td>16.5</td> <td>51.5</td> <td>20.6</td> <td>2</td> <td>2.8</td> <td>60.4</td> <td>69.4</td> <td>13.42</td> <td>22.33</td> </tr> <tr> <td>73.9</td> <td>28.2</td> <td>88.3</td> <td>26.3</td> <td>2.5</td> <td>3.35</td> <td>69.5</td> <td>79.9</td> <td>22.33</td> <td>37.39</td> </tr> <tr> <td>84.8</td> <td>46.6</td> <td>145.8</td> <td>32.9</td> <td>3</td> <td>3.96</td> <td>80.0</td> <td>89.1</td> <td>37.39</td> <td>55.76</td> </tr> </tbody> </table> <p>* For cores of less than 32 mm diameter, please refer to JKTech for recommendations.</p>					Target Particle Sizes										Nominal Core Diam. (mm)	Target		1/4 Core Length (mm)	Tolerance (mm)	Screen Aperture (mm)	Core Diameter Range		Core Volume Range		Volume cu. cm	Mass (g)	Minimum (mm)	Maximum (mm)	Minimum (cu. cm)	Maximum (cu. cm)	36.3	2.1	6.6	8.1	1	1.41	32.3	39.4	1.38	2.83	41.9	3.6	11.1	10.3	1.5	1.68	39.5	45.4	2.83	4.78	48.4	6.0	18.8	13.1	1.5	2	45.5	52.7	4.78	8.18	56.2	10.4	32.5	16.7	2	2.4	52.8	60.3	8.18	13.42	63.8	16.5	51.5	20.6	2	2.8	60.4	69.4	13.42	22.33	73.9	28.2	88.3	26.3	2.5	3.35	69.5	79.9	22.33	37.39	84.8	46.6	145.8	32.9	3	3.96	80.0	89.1	37.39	55.76
Target Particle Sizes																																																																																																				
Nominal Core Diam. (mm)	Target		1/4 Core Length (mm)	Tolerance (mm)	Screen Aperture (mm)	Core Diameter Range		Core Volume Range																																																																																												
	Volume cu. cm	Mass (g)				Minimum (mm)	Maximum (mm)	Minimum (cu. cm)	Maximum (cu. cm)																																																																																											
36.3	2.1	6.6	8.1	1	1.41	32.3	39.4	1.38	2.83																																																																																											
41.9	3.6	11.1	10.3	1.5	1.68	39.5	45.4	2.83	4.78																																																																																											
48.4	6.0	18.8	13.1	1.5	2	45.5	52.7	4.78	8.18																																																																																											
56.2	10.4	32.5	16.7	2	2.4	52.8	60.3	8.18	13.42																																																																																											
63.8	16.5	51.5	20.6	2	2.8	60.4	69.4	13.42	22.33																																																																																											
73.9	28.2	88.3	26.3	2.5	3.35	69.5	79.9	22.33	37.39																																																																																											
84.8	46.6	145.8	32.9	3	3.96	80.0	89.1	37.39	55.76																																																																																											
Click on this button to go to the Pre Start Check List. Print this out and complete it before you begin drop-testing.																																																																																																				
Click on this button if you wish to see the full SMC test procedure. This is now available via the internet.																																																																																																				
<p>Note: If the test is to be carried out on broken rock pieces, the largest screen size range possible should be selected, given the top size of the sample you are dealing with and the quantity available. If you have doubts about there being sufficient material to yield 100 particles from the selected size range, then you should switch to using the next lower size range.</p> <p>Step 1: There are two methods that can be used in the SMC test to generate the particles for breakage testing. The particles can either be cut pieces of quartered core or crushed pieces of either rock or core. The two methods are considered to be of equal accuracy, so which one is used is a matter of preference. The crush and particle select method is probably faster, so may be the preferred method when there is plenty of sample. To use this method you normally need about 20 kg, which is generally more than required for the cut core method, except when you are dealing with the largest diameter cores.</p> <p>When using the crush and particle select method, you should set the "Tests to be carried out on:" drop-down to "Broken Rock" and then select a size range from the "Select screen size to be targeted:" drop-down. The ideal size range if there is plenty of material available is the largest (ie. -31.5+26.5 mm). However, the test is most commonly carried out on -22.4+19 mm material and this is quite acceptable also. If sample quantity is very limited you may need to select the finest size range (-16+13.2 mm). Although the results are still acceptable, the test accuracy will not be quite as good using this size range, so it should only be used as a last resort when there is not enough sample to complete the test on a coarser size fraction.</p>																																																																																																				

SGS Minerals Services

Standard Bond Rod Mill Grindability Test

Project No.: 18559-01 Date: 25-Aug-21
 Sample.: SN Comp Laboratory: Lakefield (Canada)

Purpose: To determine the rod mill grindability of the sample in terms of a Bond work index number.

Procedure: The equipment and procedure duplicate the Bond method for determining rod mill work indices.

Test Conditions: Feed 100% Passing 0.5 inch
 Mesh of grind: 14 mesh
 Test feed weight (1250 mL): 3,101 grams
 Equivalent to : 2,481 kg/m³ at Minus 1/2"
 Weight % of the undersize material in the rod mill feed: 26.4%
 Weight of undersize product for 100% circulating load: 1,550 grams

Results: Gram per Rev Average for the Last Three Stages = **18.34 g**
 Circulation load = **99%**

CALCULATION OF A BOND WORK INDEX

$$RWI = \frac{62}{P_1^{0.23} \times Grp^{0.625} \times \left\{ \frac{10}{\sqrt{P}} - \frac{10}{\sqrt{F}} \right\}}$$

P₁ = 100% passing size of the product 1,180 microns
 Grp = Grams per revolution 18.34 grams
 P₈₀ = 80% passing size of product 887 microns
 F₈₀ = 80% passing size of the feed 9,679 microns

RWI = **8.4 kWh/ton (Imperial)**

RWI = **9.3 kWh/tonne (metric)**

Comments:

--

Stage No.	# of Revs	New Feed (grams)	Product in Feed (grams)	Material to Be Ground (grams)	Material Passing 14 mesh in Product (grams)	Net Ground Material (grams)	Material Ground Per Mill Rev (grams)
1	25	3,101	819	731	1,237	417	16.70
2	65	1,237	327	1,224	1,434	1,107	17.03
3	69	1,434	379	1,172	1,586	1,207	17.49
4	65	1,586	419	1,131	1,577	1,158	17.81
5	64	1,577	417	1,134	1,611	1,194	18.66
6	60	1,611	426	1,125	1,517	1,091	18.19
7	63	1,517	401	1,150	1,547	1,146	18.19

Average for Last Three Stages = 1,558 g 18.34 g

SGS Minerals Services

Standard Bond Rod Mill Grindability Test

Project No.: 18559-01
 Sample.: SN Comp

Date: 25-Aug-21
 Laboratory: Lakefield (Canada)

Feed Particle Size Analysis

Size Mesh	Size μm	Weight grams	% Retained Individual	% Retained Cumulative	% Passing Cumulative
1/2"	12,700	0.0	0.0	0.0	100.0
7/16"	11,200	213.5	11.8	11.8	88.2
3/8"	9,500	164.9	9.1	21.0	79.0
3	6,700	317.4	17.6	38.6	61.4
4	4,750	207.8	11.5	50.1	49.9
6	3,350	137.9	7.6	57.8	42.2
8	2,360	113.6	6.3	64.1	35.9
10	1,700	88.5	4.9	69.0	31.0
14	1,180	83.1	4.6	73.6	26.4
18	1,000	-	-	-	-
20	850	85.0	4.7	78.3	21.7
28	600	71.5	4.0	82.3	17.7
35	425				
48	300				
65	212				
100	150				
Pan		319.9	17.7	100.0	-
Total	-	1803.1	100.0	F₈₀: 9,679	352.3 100.0 P₈₀: 887

Product Particle Size Analysis

Weight grams	% Retained Individual	% Retained Cumulative	% Passing Cumulative
0.0	0.0	0.0	100.0
36.6	10.4	10.4	89.6
45.1	12.8	23.2	76.8
58.9	16.7	39.9	60.1
49.1	13.9	53.8	46.2
40.2	11.4	65.3	34.7
32.3	9.2	74.4	25.6
23.8	6.8	81.2	18.8
66.3	18.8	100.0	-

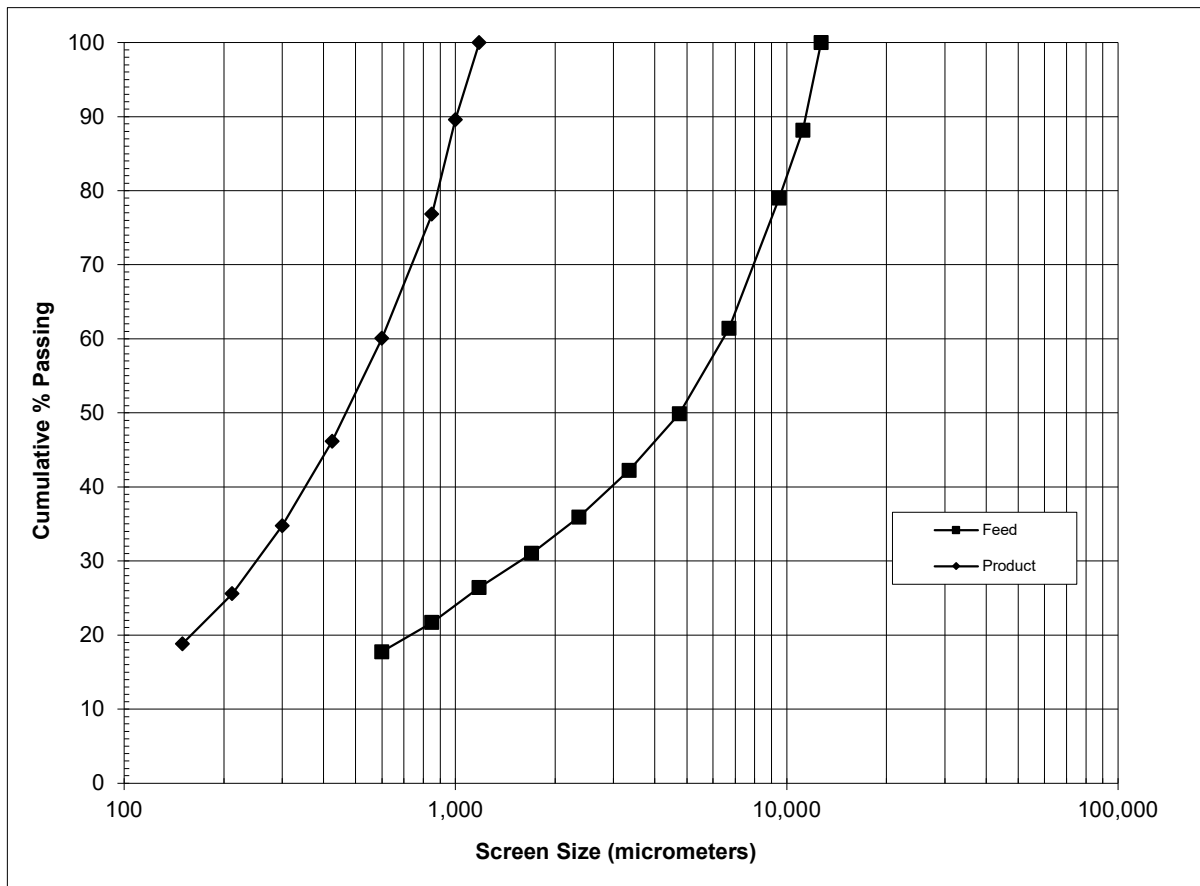

SGS Minerals Services

Standard Bond Rod Mill Grindability Test

Project No.: 18559-01 Date: 23-Aug-21
 Sample.: S Comp Laboratory: Lakefield (Canada)

Purpose: To determine the rod mill grindability of the sample in terms of a Bond work index number.

Procedure: The equipment and procedure duplicate the Bond method for determining rod mill work indices.

Test Conditions: Feed 100% Passing 0.5 inch
 Mesh of grind: 14 mesh
 Test feed weight (1250 mL): 2,984 grams
 Equivalent to : 2,387 kg/m³ at Minus 1/2"
 Weight % of the undersize material in the rod mill feed: 31.3%
 Weight of undersize product for 100% circulating load: 1,492 grams

Results: Gram per Rev Average for the Last Three Stages = **19.99 g**
 Circulation load = **96%**

CALCULATION OF A BOND WORK INDEX

$$RWI = \frac{62}{P_1^{0.23} \times Grp^{0.625} \times \left\{ \frac{10}{\sqrt{P}} - \frac{10}{\sqrt{F}} \right\}}$$

P₁ = 100% passing size of the product 1,180 microns
 Grp = Grams per revolution 19.99 grams
 P₈₀ = 80% passing size of product 884 microns
 F₈₀ = 80% passing size of the feed 9,147 microns

RWI = **8.1 kWh/ton (Imperial)**

RWI = **8.9 kWh/tonne (metric)**

Comments:

--

Stage No.	# of Revs	New Feed (grams)	Product in Feed (grams)	Material to Be Ground (grams)	Material Passing 14 mesh in Product (grams)	Net Ground Material (grams)	Material Ground Per Mill Rev (grams)
1	25	2,984	935	557	1,409	474	18.96
2	50	1,409	442	1,051	1,360	919	18.37
3	58	1,360	426	1,066	1,536	1,110	19.14
4	53	1,536	481	1,011	1,505	1,024	19.32
5	53	1,505	472	1,020	1,522	1,051	19.82
6	51	1,522	477	1,015	1,491	1,014	19.89
7	52	1,491	467	1,025	1,452	985	18.94
8	54	1,452	455	1,037	1,527	1,072	19.85
9	52	1,527	479	1,014	1,506	1,028	19.76
10	52	1,506	472	1,020	1,531	1,059	20.37

Average for Last Three Stages = 1,521 g 19.99 g

SGS Minerals Services

Standard Bond Rod Mill Grindability Test

Project No.: 18559-01
 Sample.: S Comp

Date: 23-Aug-21
 Laboratory: Lakefield (Canada)

Feed Particle Size Analysis

Size Mesh	Size μm	Weight grams	% Retained Individual	% Retained Cumulative	% Passing Cumulative
1/2"	12,700	0.0	0.0	0.0	100.0
7/16"	11,200	133.4	8.4	8.4	91.6
3/8"	9,500	154.8	9.8	18.2	81.8
3	6,700	240.0	15.2	33.4	66.6
4	4,750	175.1	11.1	44.4	55.6
6	3,350	134.7	8.5	52.9	47.1
8	2,360	100.4	6.3	59.3	40.7
10	1,700	76.1	4.8	64.1	35.9
14	1,180	72.8	4.6	68.7	31.3
18	1,000	-	-	-	-
20	850	77.1	4.9	73.5	26.5
28	600	70.9	4.5	78.0	22.0
35	425				
48	300				
65	212				
100	150				
Pan		348.2	22.0	100.0	-
Total	-	1583.5	100.0	F₈₀: 9,147	352.3 100.0 P₈₀: 884

Product Particle Size Analysis

Weight grams	% Retained Individual	% Retained Cumulative	% Passing Cumulative
0.0	0.0	0.0	100.0
39.1	11.1	11.1	88.9
40.8	11.6	22.7	77.3
53.6	15.2	37.9	62.1
47.2	13.4	51.3	48.7
41.0	11.6	62.9	37.1
32.4	9.2	72.1	27.9
25.2	7.2	79.3	20.7
73.0	20.7	100.0	-

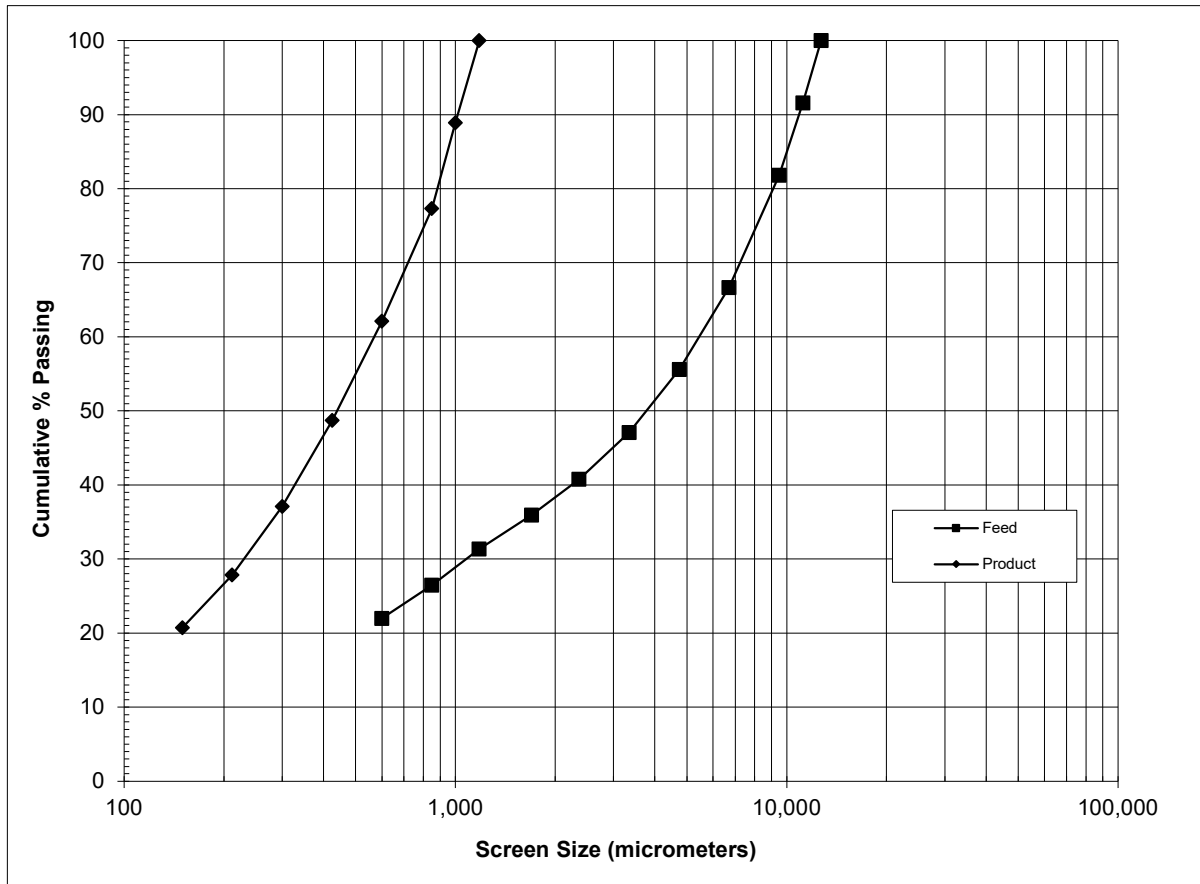

SGS Minerals Services

Standard Bond Rod Mill Grindability Test

Project No.: 18559-01 Date: 23-Aug-21
 Sample.: P Comp Laboratory: Lakefield (Canada)

Purpose: To determine the rod mill grindability of the sample in terms of a Bond work index number.

Procedure: The equipment and procedure duplicate the Bond method for determining rod mill work indices.

Test Conditions: Feed 100% Passing 0.5 inch
 Mesh of grind: 14 mesh
 Test feed weight (1250 mL): 2,722 grams
 Equivalent to : 2,177 kg/m³ at Minus 1/2"
 Weight % of the undersize material in the rod mill feed: 24.8%
 Weight of undersize product for 100% circulating load: 1,361 grams

Results: Gram per Rev Average for the Last Three Stages = **12.53 g**
 Circulation load = **99%**

CALCULATION OF A BOND WORK INDEX

$$RWI = \frac{62}{P_1^{0.23} \times Grp^{0.625} \times \left\{ \frac{10}{\sqrt{P}} - \frac{10}{\sqrt{F}} \right\}}$$

P₁ = 100% passing size of the product 1,180 microns
 Grp = Grams per revolution 12.53 grams
 P₈₀ = 80% passing size of product 849 microns
 F₈₀ = 80% passing size of the feed 9,744 microns

RWI = **10.4 kWh/ton (Imperial)**

RWI = **11.4 kWh/tonne (metric)**

Comments:

--

Stage No.	# of Revs	New Feed (grams)	Product in Feed (grams)	Material to Be Ground (grams)	Material Passing 14 mesh in Product (grams)	Net Ground Material (grams)	Material Ground Per Mill Rev (grams)
1	25	2,722	676	685	911	235	9.40
2	100	911	226	1,135	1,322	1,096	10.96
3	94	1,322	328	1,033	1,432	1,104	11.74
4	86	1,432	355	1,005	1,389	1,033	12.01
5	85	1,389	345	1,016	1,421	1,076	12.66
6	80	1,421	353	1,008	1,350	997	12.46
7	82	1,350	335	1,026	1,351	1,016	12.39
8	83	1,351	335	1,026	1,393	1,057	12.74

Average for Last Three Stages = 1,364 g 12.53 g

SGS Minerals Services

Standard Bond Rod Mill Grindability Test

Project No.: 18559-01
 Sample.: P Comp

Date: 23-Aug-21
 Laboratory: Lakefield (Canada)

Feed Particle Size Analysis

Size Mesh	Size μm	Weight grams	% Retained Individual	% Retained Cumulative	% Passing Cumulative
1/2"	12,700	0.0	0.0	0.0	100.0
7/16"	11,200	114.5	8.6	8.6	91.4
3/8"	9,500	177.2	13.3	21.9	78.1
3	6,700	247.9	18.6	40.6	59.4
4	4,750	172.4	13.0	53.5	46.5
6	3,350	106.1	8.0	61.5	38.5
8	2,360	79.8	6.0	67.5	32.5
10	1,700	57.4	4.3	71.8	28.2
14	1,180	45.0	3.4	75.2	24.8
18	1,000	-	-	-	-
20	850	40.2	3.0	78.2	21.8
28	600	32.5	2.4	80.6	19.4
35	425				
48	300				
65	212				
100	150				
Pan		257.7	19.4	100.0	-
Total	-	1330.7	100.0	F₈₀: 9,744	355.2 100.0 P₈₀: 849

Product Particle Size Analysis

Weight grams	% Retained Individual	% Retained Cumulative	% Passing Cumulative
0.0	0.0	0.0	100.0
33.8	9.5	9.5	90.5
37.0	10.4	19.9	80.1
46.3	13.0	33.0	67.0
38.9	11.0	43.9	56.1
34.6	9.7	53.7	46.3
32.1	9.0	62.7	37.3
28.7	8.1	70.8	29.2
103.8	29.2	100.0	-

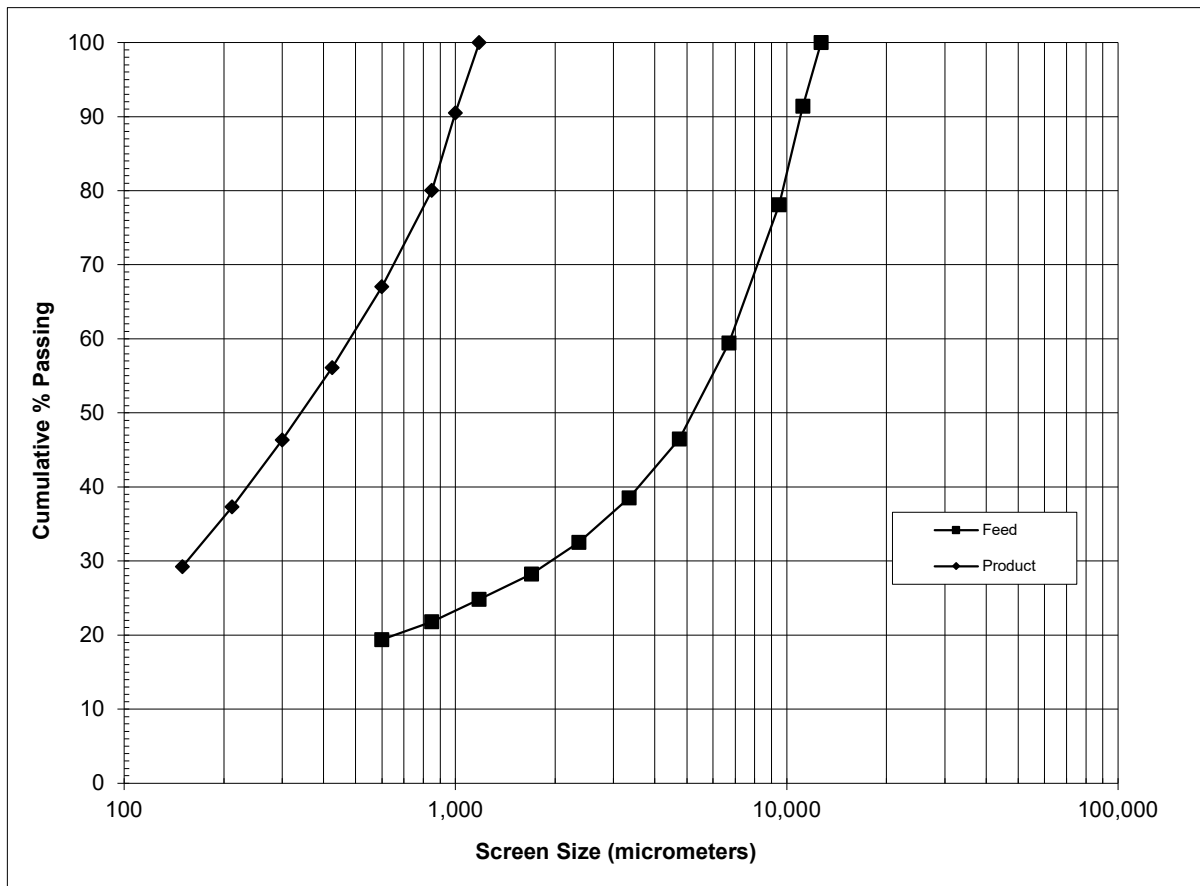

SGS Minerals Services

Standard Bond Ball Mill Grindability Test

Project No.: 18559-01 Date: 21-Jul-21
 Sample: SN Comp Laboratory: Lakefield (Canada)

Purpose: The equipment and procedure duplicate the Bond method for determining ball mill work indices.

Procedure: The equipment and procedure duplicate the Bond method for determining ball mill work indices.

Test Conditions: Feed 100% Passing 6 mesh
 Mesh of grind: 100 mesh
 Test feed weight (700 mL): 1,725 grams
 Equivalent to : 2,464 kg/m³ at Minus 6 mesh
 Weight % of the undersize material in the ball mill feed: 13.7%
 Weight of undersize product for 250% circulating load: 493 grams

Results: Gram per Rev Average for the Last Three Stages = **1.98 g**
 Circulation load = **252%**

CALCULATION OF A BOND WORK INDEX

$$BWI = \frac{44.5}{P_1^{0.23} \times Grp^{0.82} \times \left\{ \frac{10}{\sqrt{P}} - \frac{10}{\sqrt{F}} \right\}}$$

P₁ = 100% passing size of the product 150 microns
 Grp = Grams per revolution 1.98 grams
 P₈₀ = 80% passing size of product 123 microns
 F₈₀ = 80% passing size of the feed 2,129 microns

BWI = 11.7 kWh/ton (Imperial)

BWI = 12.9 kWh/tonne (metric)

Comments:

--

Stage No.	# of Revs	New Feed (grams)	Product in Feed (grams)	Material to Be Ground (grams)	Material Passing 100 mesh in Product (grams)	Net Ground Material (grams)	Material Ground Per Mill Rev (grams)
1	100	1,725	237	256	415	178	1.78
2	245	415	57	436	500	443	1.81
3	235	500	69	424	539	470	2.00
4	209	539	74	419	499	425	2.03
5	209	499	68	424	484	415	1.99
6	215	484	66	426	490	423	1.97
7	216	490	67	426	498	430	1.99

Average for Last Three Stages = 490 g 1.98 g

SGS Minerals Services

Standard Bond Ball Mill Grindability Test

Project No.: 18559-01
 Sample: SN Comp

Date: 21-Jul-21
 Laboratory: Lakefield (Canada)

Feed Particle Size Analysis

Mesh	Size µm	Weight grams	% Retained		% Passing Cumulative
			Individual	Cumulative	
6	3,360	0.0	0.0	0.0	100.0
7	2,800	53.2	6.8	6.8	93.2
8	2,360	65.1	8.3	15.0	85.0
10	1,700	116.3	14.8	29.8	70.2
14	1,180	103.6	13.2	43.0	57.0
20	850	70.9	9.0	52.0	48.0
28	600	69.4	8.8	60.9	39.1
35	425	62.2	7.9	68.8	31.2
48	300	55.2	7.0	75.8	24.2
65	212	43.4	5.5	81.3	18.7
100	150	38.9	4.9	86.3	13.7
115	125	-	-	88.4	11.6
150	106	29.4	3.7	90.0	10.0
200	75				
270	53				
400	38				
Pan	-	78.5	10.0	100.0	-
Total	-	786.1	100.0	F₈₀: 2,129	155.0

Product Particle Size Analysis

Weight grams	% Retained		% Passing Cumulative
	Individual	Cumulative	
0.0	0.0	0.0	100.0
0.0	0.0	0.0	100.0
28.1	18.1	18.1	81.9
23.2	15.0	33.1	66.9
32.2	20.8	53.9	46.1
20.5	13.2	67.1	32.9
14.1	9.1	76.2	23.8
36.9	23.8	100.0	-
P₈₀: 123			

Values in italics were interpolated

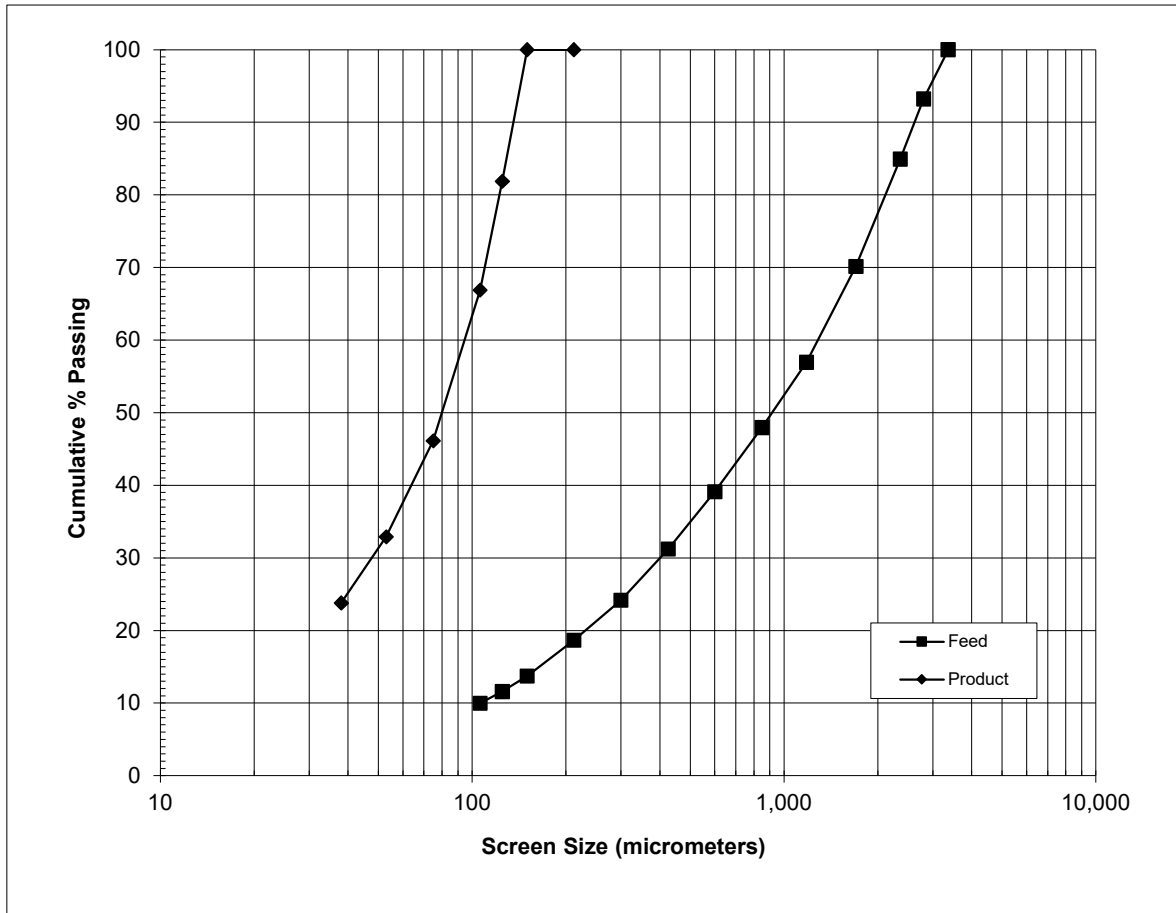

SGS Minerals Services

Standard Bond Ball Mill Grindability Test

Project No.: 18559-01 Date: 14-Jul-21
 Sample: S Comp Laboratory: Lakefield (Canada)

Purpose: The equipment and procedure duplicate the Bond method for determining ball mill work indices.

Procedure: The equipment and procedure duplicate the Bond method for determining ball mill work indices.

Test Conditions: Feed 100% Passing 6 mesh
 Mesh of grind: 100 mesh
 Test feed weight (700 mL): 1,634 grams
 Equivalent to : 2,334 kg/m³ at Minus 6 mesh
 Weight % of the undersize material in the ball mill feed: 14.9%
 Weight of undersize product for 250% circulating load: 467 grams

Results: Gram per Rev Average for the Last Three Stages = **1.89 g**
 Circulation load = **240%**

CALCULATION OF A BOND WORK INDEX

$$BWI = \frac{44.5}{P_1^{0.23} \times Grp^{0.82} \times \left\{ \frac{10}{\sqrt{P}} - \frac{10}{\sqrt{F}} \right\}}$$

P₁ = 100% passing size of the product 150 microns
 Grp = Grams per revolution 1.89 grams
 P₈₀ = 80% passing size of product 126 microns
 F₈₀ = 80% passing size of the feed 2,035 microns

BWI = **12.4 kWh/ton (Imperial)**

BWI = **13.7 kWh/tonne (metric)**

Comments:

Stage 3: 3x10 min shakes
 Stage 6: Replaced 1 test sieve. Hole found

Stage No.	# of Revs	New Feed (grams)	Product in Feed (grams)	Material to Be Ground (grams)	Material Passing 100 mesh in Product (grams)	Net Ground Material (grams)	Material Ground Per Mill Rev (grams)
1	100	1,634	243	224	448	205	2.05
2	195	448	67	400	420	353	1.81
3	223	420	62	404	499	437	1.96
4	201	499	74	393	497	423	2.10
5	187	497	74	393	478	404	2.16
6	183	478	71	396	432	361	1.97
7	204	432	64	403	454	390	1.91
8	209	454	67	399	452	385	1.84
9	217	452	67	400	459	392	1.81
10	221	459	68	399	501	433	1.96
11	210	501	74	392	456	382	1.82
12	220	456	68	399	484	416	1.89
Average for Last Three Stages =					480 g		1.89 g

SGS Minerals Services

Standard Bond Ball Mill Grindability Test

Project No.: 18559-01
 Sample: S Comp

Date: 14-Jul-21
 Laboratory: Lakefield (Canada)

Feed Particle Size Analysis

Mesh	Size µm	Weight grams	% Retained		% Passing Cumulative
			Individual	Cumulative	
6	3,360	0.0	0.0	0.0	100.0
7	2,800	51.6	6.2	6.2	93.8
8	2,360	65.8	7.9	14.1	85.9
10	1,700	104.3	12.5	26.6	73.4
14	1,180	100.2	12.0	38.7	61.3
20	850	73.0	8.8	47.4	52.6
28	600	75.8	9.1	56.5	43.5
35	425	73.2	8.8	65.3	34.7
48	300	66.8	8.0	73.3	26.7
65	212	51.4	6.2	79.5	20.5
100	150	46.9	5.6	85.1	14.9
115	125	-	-	87.5	12.5
150	106	34.1	4.1	89.2	10.8
200	75				
270	53				
400	38				
Pan	-	89.6	10.8	100.0	-
Total	-	832.7	100.0	F₈₀: 2,035	P₈₀: 126

Product Particle Size Analysis

Weight grams	% Retained		% Passing Cumulative
	Individual	Cumulative	
0.0	0.0	0.0	100.0
0.0	0.0	0.0	100.0
31.8	20.5	20.5	79.5
22.8	14.7	35.1	64.9
30.7	19.8	54.9	45.1
20.3	13.1	68.0	32.0
13.4	8.6	76.6	23.4
36.4	23.4	100.0	-
155.4	100.0	P₈₀: 126	

Values in italics were interpolated

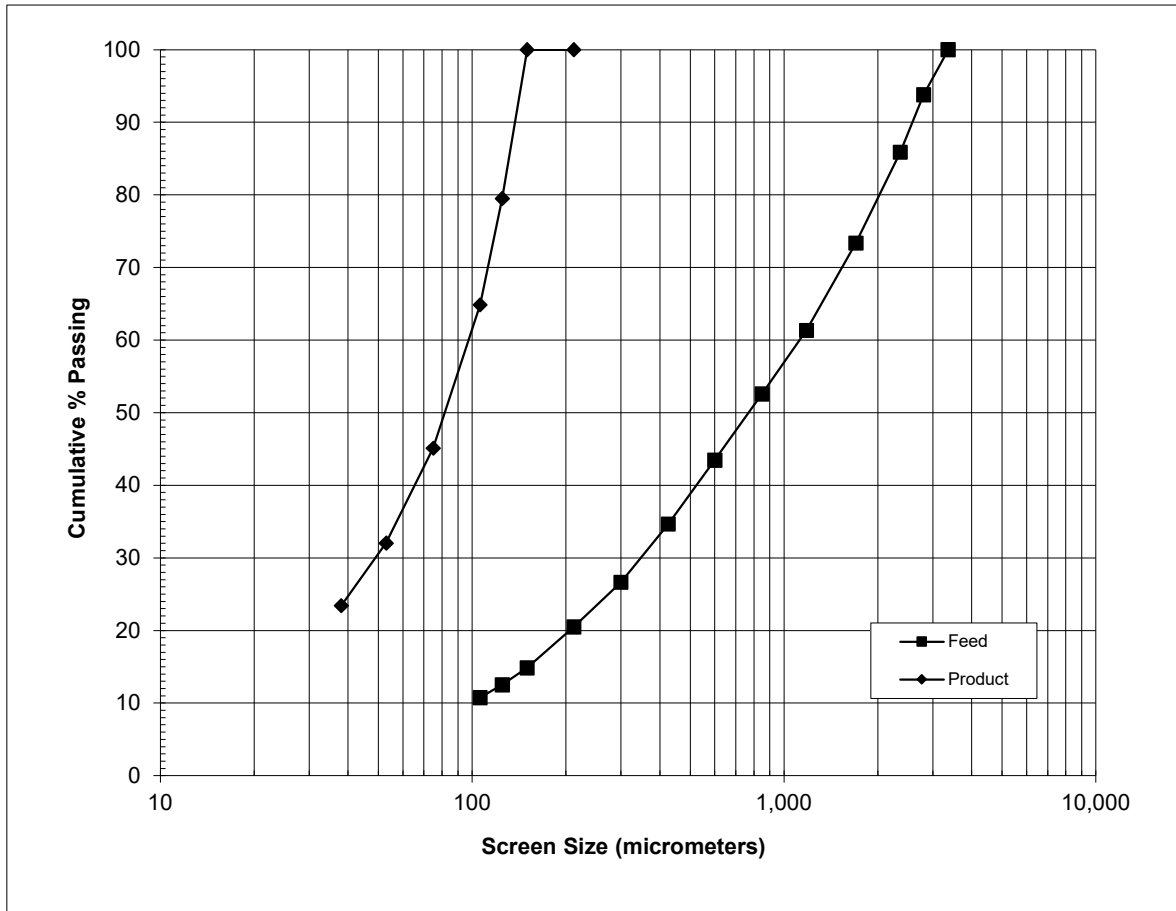

SGS Minerals Services

Standard Bond Ball Mill Grindability Test

Project No.: 18559-01 Date: 12-Jul-21
 Sample: P Comp Laboratory: Lakefield (Canada)

Purpose: The equipment and procedure duplicate the Bond method for determining ball mill work indices.

Procedure: The equipment and procedure duplicate the Bond method for determining ball mill work indices.

Test Conditions: Feed 100% Passing 6 mesh
 Mesh of grind: 100 mesh
 Test feed weight (700 mL): 1,544 grams
 Equivalent to : 2,205 kg/m³ at Minus 6 mesh
 Weight % of the undersize material in the ball mill feed: 20.8%
 Weight of undersize product for 250% circulating load: 441 grams

Results: Gram per Rev Average for the Last Three Stages = **1.91 g**
 Circulation load = **250%**

CALCULATION OF A BOND WORK INDEX

$$BWI = \frac{44.5}{P_1^{0.23} \times Grp^{0.82} \times \left\{ \frac{10}{\sqrt{P}} - \frac{10}{\sqrt{F}} \right\}}$$

P₁ = 100% passing size of the product 150 microns
 Grp = Grams per revolution 1.91 grams
 P₈₀ = 80% passing size of product 129 microns
 F₈₀ = 80% passing size of the feed 2,207 microns

BWI = **12.4 kWh/ton (Imperial)**

BWI = **13.7 kWh/tonne (metric)**

Comments:

Stage 3: 3x10 minute shakes

Stage No.	# of Revs	New Feed (grams)	Product in Feed (grams)	Material to Be Ground (grams)	Material Passing 100 mesh in Product (grams)	Net Ground Material (grams)	Material Ground Per Mill Rev (grams)
1	100	1,544	321	120	526	204	2.04
2	162	526	109	332	420	310	1.91
3	185	420	87	354	440	352	1.90
4	184	440	91	350	444	352	1.91
5	182	444	92	349	436	343	1.89
6	186	436	91	350	448	357	1.92
7	181	448	93	348	440	346	1.91

Average for Last Three Stages = 441 g 1.91 g

SGS Minerals Services

Standard Bond Ball Mill Grindability Test

Project No.: 18559-01
 Sample: P Comp

Date: 12-Jul-21
 Laboratory: Lakefield (Canada)

Feed Particle Size Analysis

Mesh	Size µm	Weight grams	% Retained		% Passing Cumulative
			Individual	Cumulative	
6	3,360	0.0	0.0	0.0	100.0
7	2,800	56.7	8.1	8.1	91.9
8	2,360	62.7	8.9	17.0	83.0
10	1,700	96.8	13.8	30.7	69.3
14	1,180	79.9	11.4	42.1	57.9
20	850	48.0	6.8	48.9	51.1
28	600	42.9	6.1	55.0	45.0
35	425	41.7	5.9	61.0	39.0
48	300	42.7	6.1	67.0	33.0
65	212	41.3	5.9	72.9	27.1
100	150	44.2	6.3	79.2	20.8
115	125	-	-	82.2	17.8
150	106	36.6	5.2	84.4	15.6
200	75				
270	53				
400	38				
Pan	-	109.7	15.6	100.0	-
Total	-	703.2	100.0	F₈₀: 2,207	157.0

Product Particle Size Analysis

Weight grams	% Retained		% Passing Cumulative
	Individual	Cumulative	
0.0	0.0	0.0	100.0
0.0	0.0	0.0	100.0
36.8	23.4	23.4	76.6
20.8	13.2	36.7	63.3
29.1	18.5	55.2	44.8
19.4	12.4	67.6	32.4
14.6	9.3	76.9	23.1
36.3	23.1	100.0	-
P₈₀: 129			

Values in italics were interpolated

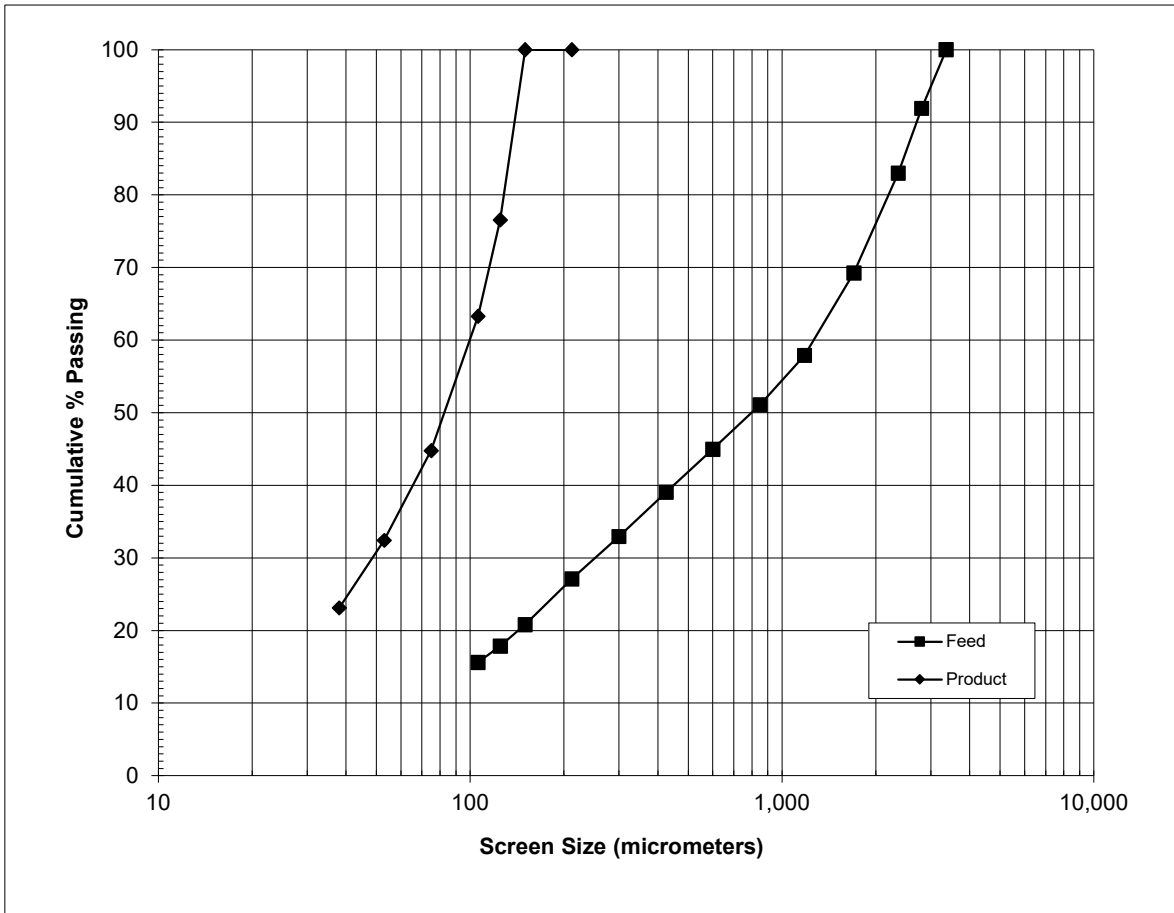

SGS Minerals Services

STANDARD BOND ABRASION TEST

Project No.: 18559-01

Date (mm/dd/yy): 8-Jul-21

Sample: SN Comp

SGS Laboratory: Lakefield (Canada)

Technician: OHTA

Purpose: To determine the Abrasion Index of the sample

Procedure: The equipment and procedure duplicate the Bond method for determining an abrasion index.

Feed: 1,600 grams minus 3/4 inch plus 1/2 inch fraction

Number of cycles of 15 minutes: 4 Cycles

Reading:		#1	#2	Average
Results:	Original paddle weight, grams:	94.6084	94.6083	94.6084
	Final paddle weight, grams:	94.4294	94.4292	94.4293

Abrasion Index, Ai:**0.179**

Predicted Wear Rates:

		lb/kwh	kg/kwh
Wet rod mill, rods:	$0.35*(Ai-0.020)^{0.20}$	0.24	0.11
Wet rod mill, liners:	$0.035*(Ai-0.015)^{0.30}$	0.020	0.009
<i>Ball Mill (overflow and grate discharge types)</i>			
Wet ball mill, balls:	$0.35*(Ai-0.015)^{0.33}$	0.19	0.087
Wet ball mill, liners:	$0.026*(Ai-0.015)^{0.30}$	0.015	0.0069
<i>Ball Mill (grate discharge type)</i>			
Dry ball mill, balls:	$0.05*(Ai)^{0.5}$	0.021	0.010
Dry ball mill, liners:	$0.005*(Ai)^{0.5}$	0.0021	0.0010
<i>Crushers (gyratory, jaw, cone)</i>			
Crusher, liners:	$(Ai+0.22)/11$	0.036	0.016
Roll crusher, shells:	$(Ai/10)^{0.67}$	0.068	0.031

SGS Minerals Services

STANDARD BOND ABRASION TEST

Project No.: 18559-01
Sample: SN Comp

Date: 8-Jul-21
SGS Laboratory: Lakefield (Canada)

Product Particle Size Analysis

Mesh	Size	Weight grams	% Retained		% Passing
	μm		Individual	Cumulative	Cumulative
1/2 in	12,700	51.6	6.36	6.36	93.6
3/8 in	9,500	65.4	8.06	14.4	85.6
3	6,700	22.8	2.81	17.2	82.8
4	4,750	16.4	2.02	19.3	80.7
6	3,350	15.2	1.87	21.1	78.9
8	2,360	28.6	3.53	24.7	75.3
10	1,700	30.2	3.72	28.4	71.6
14	1,180	33.2	4.09	32.5	67.5
20	850	40.6	5.00	37.5	62.5
28	600	49.4	6.09	43.6	56.4
35	425	63.5	7.83	51.4	48.6
48	300	72.1	8.89	60.3	39.7
65	212	70.5	8.69	69.0	31.0
100	150	45.1	5.56	74.5	25.5
-100	-150	206.6	25.5	100.0	-
	Total	811.2	100.0	K80	4,139

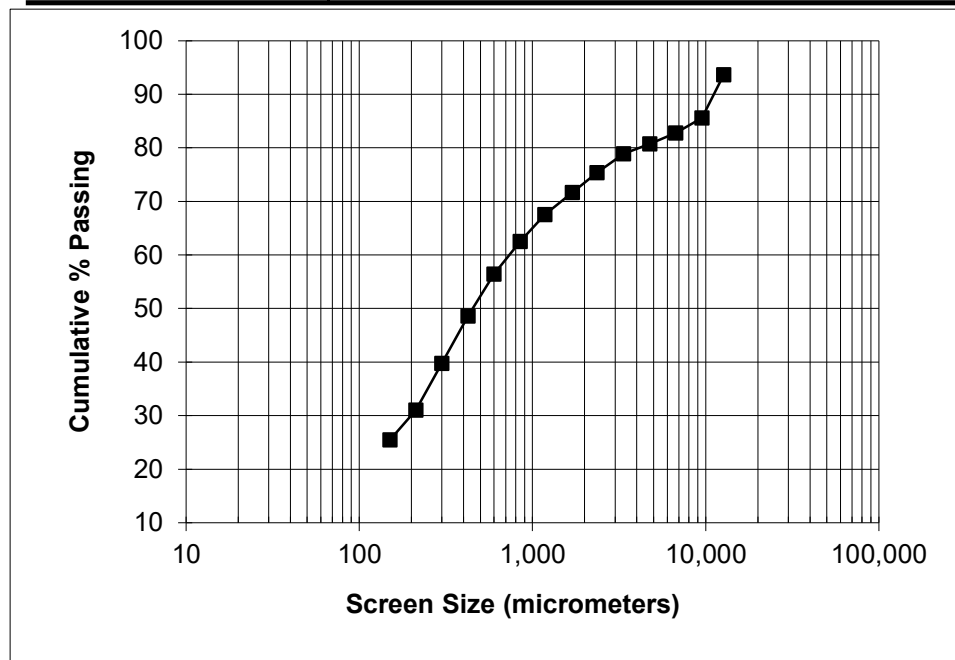

SGS Minerals Services

STANDARD BOND ABRASION TEST

Project No.: 18559-01

Date (mm/dd/yy): 8-Jul-21

Sample: S Comp

SGS Laboratory: Lakefield (Canada)

Technician: OHTA

Purpose: To determine the Abrasion Index of the sample

Procedure: The equipment and procedure duplicate the Bond method for determining an abrasion index.

Feed: 1,600 grams minus 3/4 inch plus 1/2 inch fraction

Number of cycles of 15 minutes: 4 Cycles

Reading:	#1	#2	Average
Original paddle weight, grams:	94.4294	94.4287	94.4291
Final paddle weight, grams:	94.2614	94.2614	94.2614

Abrasion Index, Ai:**0.168**

Predicted Wear Rates:

		<u>lb/kwh</u>	<u>kg/kwh</u>
Wet rod mill, rods:	$0.35*(Ai-0.020)^{0.20}$	0.24	0.11
Wet rod mill, liners:	$0.035*(Ai-0.015)^{0.30}$	0.020	0.009
<i>Ball Mill (overflow and grate discharge types)</i>			
Wet ball mill, balls:	$0.35*(Ai-0.015)^{0.33}$	0.19	0.085
Wet ball mill, liners:	$0.026*(Ai-0.015)^{0.30}$	0.015	0.0067
<i>Ball Mill (grate discharge type)</i>			
Dry ball mill, balls:	$0.05*(Ai)^{0.5}$	0.020	0.009
Dry ball mill, liners:	$0.005*(Ai)^{0.5}$	0.0020	0.0009
<i>Crushers (gyratory, jaw, cone)</i>			
Crusher, liners:	$(Ai+0.22)/11$	0.035	0.016
Roll crusher, shells:	$(Ai/10)^{0.67}$	0.065	0.029

SGS Minerals Services

STANDARD BOND ABRASION TEST

Project No.: 18559-01
 Sample: S Comp

Date: 8-Jul-21
 SGS Laboratory: Lakefield (Canada)

Product Particle Size Analysis

Mesh	Size	Weight grams	% Retained		% Passing
	µm		Individual	Cumulative	Cumulative
1/2 in	12,700	47.2	5.83	5.83	94.2
3/8 in	9,500	55.2	6.82	12.7	87.3
3	6,700	22.1	2.73	15.4	84.6
4	4,750	17.4	2.15	17.5	82.5
6	3,350	16.2	2.00	19.5	80.5
8	2,360	28.9	3.57	23.1	76.9
10	1,700	29.7	3.67	26.8	73.2
14	1,180	30.4	3.76	30.5	69.5
20	850	35.9	4.44	35.0	65.0
28	600	47.6	5.88	40.8	59.2
35	425	65.5	8.09	48.9	51.1
48	300	79.4	9.81	58.7	41.3
65	212	78.9	9.75	68.5	31.5
100	150	49.2	6.08	74.6	25.4
-100	-150	205.8	25.4	100.0	-
	Total	809.4	100.0	K80	3,203

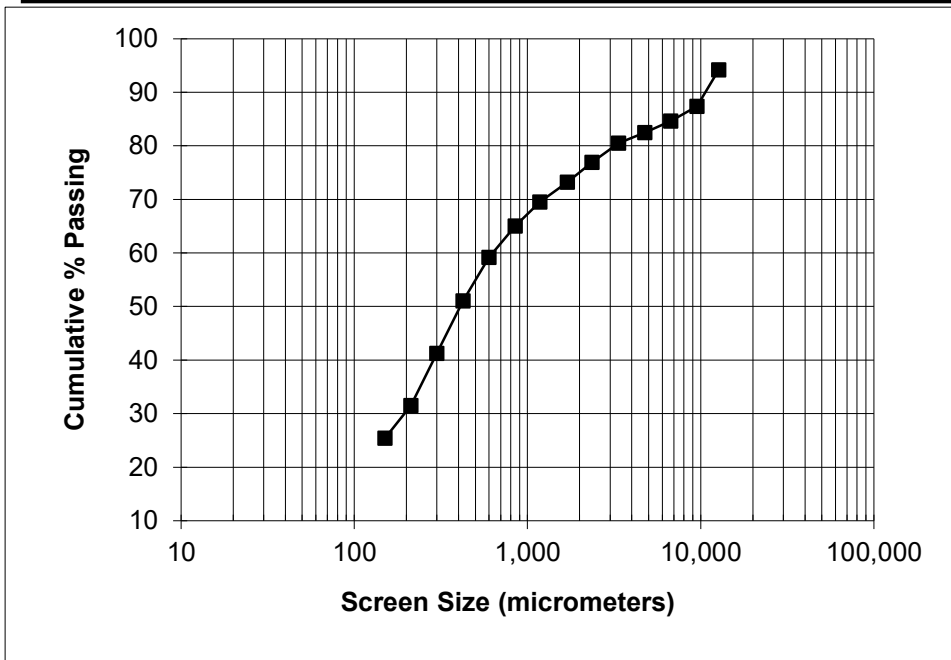

SGS Minerals Services

STANDARD BOND ABRASION TEST

Project No.: 18559-01

Date (mm/dd/yy): 7-Jul-21

Sample: P Comp

SGS Laboratory: Lakefield (Canada)

Technician: OHTA

Purpose: To determine the Abrasion Index of the sample

Procedure: The equipment and procedure duplicate the Bond method for determining an abrasion index.

Feed: 1,600 grams minus 3/4 inch plus 1/2 inch fraction

Number of cycles of 15 minutes: 4 Cycles

Reading:	#1	#2	Average
Original paddle weight, grams:	94.1382	94.1380	94.1381
Final paddle weight, grams:	93.9815	93.9808	93.9812

Abrasion Index, Ai:**0.157**

Predicted Wear Rates:

		<u>lb/kwh</u>	<u>kg/kwh</u>
Wet rod mill, rods:	$0.35*(Ai-0.020)^{0.20}$	0.24	0.11
Wet rod mill, liners:	$0.035*(Ai-0.015)^{0.30}$	0.019	0.009
<i>Ball Mill (overflow and grate discharge types)</i>			
Wet ball mill, balls:	$0.35*(Ai-0.015)^{0.33}$	0.18	0.083
Wet ball mill, liners:	$0.026*(Ai-0.015)^{0.30}$	0.014	0.0066
<i>Ball Mill (grate discharge type)</i>			
Dry ball mill, balls:	$0.05*(Ai)^{0.5}$	0.020	0.009
Dry ball mill, liners:	$0.005*(Ai)^{0.5}$	0.0020	0.0009
<i>Crushers (gyratory, jaw, cone)</i>			
Crusher, liners:	$(Ai+0.22)/11$	0.034	0.016
Roll crusher, shells:	$(Ai/10)^{0.67}$	0.062	0.028

SGS Minerals Services

STANDARD BOND ABRASION TEST

Project No.: 18559-01

Date: 7-Jul-21

Sample: P Comp

SGS Laboratory: Lakefield (Canada)

Product Particle Size Analysis

Mesh	Size	Weight grams	% Retained		% Passing
	µm		Individual	Cumulative	Cumulative
1/2 in	12,700	59.3	7.70	7.70	92.3
3/8 in	9,500	111.2	14.4	22.1	77.9
3	6,700	48.4	6.28	28.4	71.6
4	4,750	32.1	4.17	32.6	67.4
6	3,350	27.8	3.61	36.2	63.8
8	2,360	22.0	2.86	39.0	61.0
10	1,700	15.6	2.02	41.1	58.9
14	1,180	12.6	1.64	42.7	57.3
20	850	12.1	1.57	44.3	55.7
28	600	14.7	1.91	46.2	53.8
35	425	23.1	3.00	49.2	50.8
48	300	35.9	4.66	53.8	46.2
65	212	55.3	7.18	61.0	39.0
100	150	45.2	5.87	66.9	33.1
-100	-150	255.1	33.1	100.0	-
	Total	770.4	100.0	K80	9,948

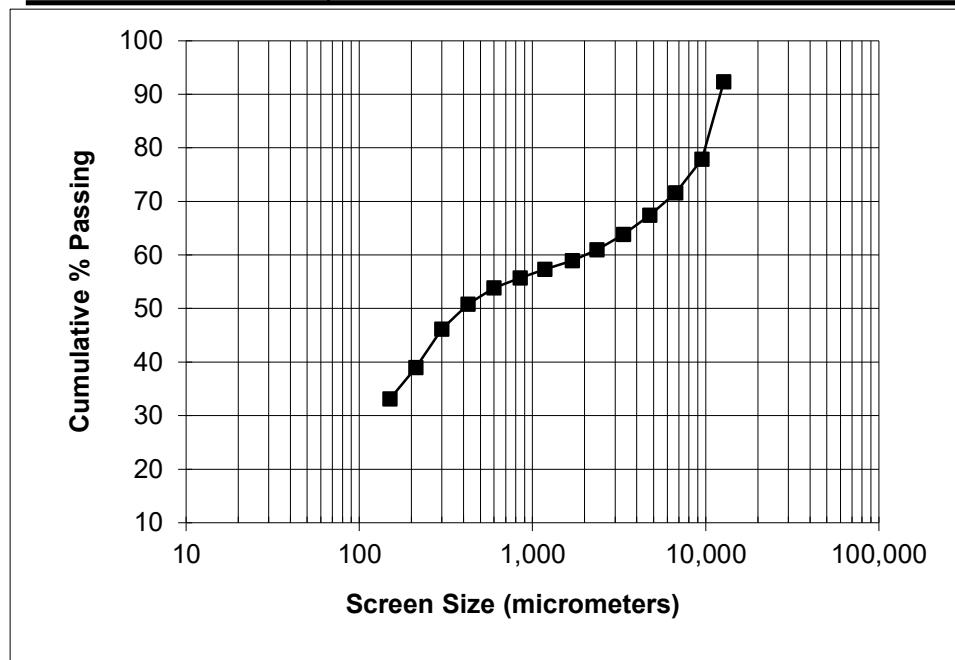

Appendix D – Batch Flotation Testing

Test: F1 **Project:** 18559-01 **Date:** June 24, 2021 **Operator:** Deepak
Purpose: Conduct initial rougher kinetics test
Procedure: As outlined below.
Feed: 2kg SN Comp -10 mesh Freezer\SEC-11C
Grind: 34 minutes at 65% solids in 2 kg Rod Mill #3 Comb Prod P₈₀ = 100 µm
Regrind: N/A

Conditions:

Stage	Reagents added, grams per tonne						Time, minutes			pH	ORP, mV
	Lime	CusO4		PAX	MIBC		Grind	Cond.	Froth		
Grind	625			5			34			9.4	-26
Rougher 1	0				0			1	1	9.4	-26
Rougher 2	0			5	0			1	2	9.3	31
Rougher 3	0			5	0			1	2	9.2	41
Rougher 4	0			10	0			1	3	natural pH	54
Rougher 5	0			20	0			1	5	natural pH	41
Rougher 6	0	50		20	0			1	5	natural pH	59
Magnetic separation on Ro Tails by Handheld magnet 1350 G											
Mag Scav									5		
Total	625	50		60	0	0			23		

* Add as required.

Stage	Rougher/Scavenger	Po Rougher	Cu/Ni 1st/2nd Cleaner	Po 1st & 2nd Cl
Flotation Cell	2 kg float cell	2 kg float cell	500g/250g float cell	250g float cell
Speed: r.p.m.	1800	1800	1500/1200	1200

Metallurgical Balance

Product	Weight		Assays, %								% Distribution						
	g	%	Cu	Ni	S	Other	Cp	Pn	Po	Ga	Cu	Ni	S	Cp	Pn	Po	Ga
Ro Conc 1	138.8	6.9	13.1	7.82	32.9	46.2	38.0	21.3	32.7	8.06	86.9	46.3	13.4	86.9	55.3	5.8	1.0
Ro Conc 2	226.2	11.2	1.01	2.80	34.8	61.4	2.93	6.63	82.0	8.40	10.9	27.0	23.1	10.9	28.1	23.6	1.7
Ro Conc 3	156.3	7.8	0.15	1.29	35.4	63.2	0.43	2.33	89.6	7.68	1.1	8.6	16.2	1.1	6.8	17.8	1.1
Ro Conc 4	206.0	10.2	0.05	0.93	34.9	64.1	0.16	1.34	89.4	9.15	0.5	8.2	21.1	0.5	5.2	23.4	1.7
Ro Conc 5	189.6	9.4	0.03	0.75	33.1	66.1	0.07	0.89	85.1	13.9	0.2	6.1	18.4	0.2	3.2	20.6	2.4
Ro Conc 6	70.6	3.5	0.03	0.64	31.5	67.8	0.09	0.64	81.2	18.1	0.1	1.9	6.5	0.1	0.8	7.3	1.1
Mag Scav Conc	149.5	7.4	<0.01	0.05	1.05	98.9	0.01	0.04	2.68	97.3	0.0	0.3	0.5	0.0	0.1	0.5	13.0
Mag Scav Tails	878.3	43.6	<0.01	0.04	0.35	99.6	0.01	0.03	0.87	99.1	0.2	1.5	0.9	0.2	0.5	1.0	78.0
Head (Calc.)	2015.3	100	1.04	1.16	16.9	80.9	3.01	2.65	39.0	55.4	100	100	100	100	100	100	100
Head (Dir.)			1.07	1.17	16.5	81.3	3.10	2.69	37.7	56.5							

0.005 was used for <0.01 calculation

Combined Products

Ro Conc 1		6.9	13.1	7.82	32.9	46.2	38.0	21.3	32.7	8.1	86.9	46.3	13.4	86.9	55.3	5.8	1.0
Ro Conc 1-2		18.1	5.61	4.71	34.1	55.6	16.3	12.2	63.3	8.3	97.8	73.4	36.4	97.8	83.4	29.4	2.7
Ro Conc 1-3		25.9	3.97	3.68	34.5	57.9	11.5	9.24	71.2	8.1	98.9	82.0	52.7	98.9	90.2	47.2	3.8
Ro Conc 4		10.2	0.05	0.93	34.9	64.1	0.16	1.34	89.4	9.1	0.5	8.2	21.1	0.5	5.2	23.4	1.7
Ro Conc 4-5		19.6	0.04	0.84	34.0	65.1	0.12	1.12	87.3	11.4	0.8	14.2	39.5	0.8	8.3	44.0	4.0
Ro Conc 4-6		23.1	0.04	0.81	33.7	65.5	0.11	1.05	86.4	12.4	0.9	16.2	46.0	0.9	9.2	51.3	5.2
Mag Scav Conc		7.4	0.01	0.05	1.05	98.9	0.01	0.04	2.68	97.3	0.0	0.3	0.5	0.0	0.1	0.5	13.0
Ro Conc 1-6		49.0	2.11	2.33	34.1	61.5	6.13	5.37	78.4	10.1	99.8	98.1	98.6	99.8	99.4	98.5	9.0
Po Ro Feed		74.1	0.02	0.28	10.8	88.9	0.0	0.35	27.7	71.9	1.1	18.0	47.3	1.1	9.8	52.8	96.2

Test: F2 Project: 18559-01 Date: June 24, 2021 Operator: Deepak

Purpose: Conduct initial open-circuit cleaning test.

Procedure: As outlined below.

Feed: 2kg SN Comp -10 mesh Freezer\SEC-11C

Grind: 34 minutes at 65% solids in 2 kg Rod Mill # 3

Po Ro Tails P₈₀ = 105 µm

Regrind 12 minutes at 50% solids in 2 kg Rod Mill for Cu/Ni R.Conc

P₈₀ = 34 µm Malvern

24 minutes at 50% solids in 2 kg Rod Mill for Po R.Conc

P₈₀ = 33 µm Malvern

Conditions:

Stage	Reagents added, grams per tonne						Time, minutes			pH	ORP, mV
	Lime	CuSO4	PAX	MIBC*			Grind	Cond.	Froth		
Grind	625		5				34			9.4	-92
Cu/Ni Rougher No. 1	0			0				1	1	9.4	-92
Cu/Ni Rougher No. 2	0		5	0				1	2	9.3	-3
Cu/Ni Rougher No. 3	0		5	0				1	2	9.2	44
Regrind (2kg Rod Mill)	150		1				12			9.2	75
Cu/Ni 1st Cleaner No.1	10			0				1	2	9.5	75
Cu/Ni 1st Cleaner No.2	5		1	0				1	2	9.5	79
Cu/Ni 1st Cleaner No.3	20		1	0				1	3	9.5	89
Po Rougher No. 1		50	10	0				1	3	natural pH	21
Po Rougher No. 2			20	0				1	5	natural pH	14
Po Rougher No. 3			20	0				1	5	natural pH	23
<i>Po Cleaning on Po Ro Con 1-3</i>											
Regrind (2kg Rod Mill)	200		1				24			9.2	-24
Po 1st Cleaner No.1	0			0				1	2	9.2	-24
Po 1st Cleaner No.2	10		1	0				1	2	9.0	75
Po 1st Cleaner No.3	5		1	0				1	2	9.0	75
Po 1st Cleaner No.4	15		2	0				1	2	9.4	61
Total	415	50	73	0	0	0			33		

* Add as required.

Stage	Rougher/Scavenger	Po Rougher	Cu/Ni 1st/2nd Cleaner	Po 1st & 2nd Cl
Flotation Cell	2 kg float cell	2 kg float cell	500g/250g float cell	250g float cell
Speed: r.p.m.	1800	1800	1500/1200	1200

Metallurgical Balance

Product	Weight		Assays, %								% Distribution						
	g	%	Cu	Ni	S	Other	Cp	Pn	Po	Ga	Cu	Ni	S	Cp	Pn	Po	Ga
Cu/Ni 1st Cl Conc 1	158.5	7.8	11.3	7.85	35.4	45.5	32.8	21.2	44.0	2.05	86.6	52.4	16.9	86.6	61.5	9.2	0.3
Cu/Ni 1st Cl Conc 2	63.1	3.1	2.70	4.67	35.9	56.7	7.83	11.9	75.9	4.34	8.2	12.4	6.8	8.2	13.8	6.3	0.2
Cu/Ni 1st Cl Conc 3	49.3	2.4	0.45	2.30	36.2	61.1	1.30	5.16	88.4	5.12	1.1	4.8	5.4	1.1	4.7	5.7	0.2
Cu/Ni 1st Cl Tails	132.4	6.5	0.23	1.23	30.6	67.9	0.67	2.33	76.9	20.1	1.5	6.9	12.2	1.5	5.7	13.4	2.3
Po 1st Cl Conc 1	300.0	14.8	0.10	1.03	35.5	63.4	0.29	1.60	90.6	7.54	1.5	13.0	32.1	1.5	8.8	35.8	2.0
Po 1st Cl Conc 2	127.5	6.3	0.08	0.85	34.8	64.3	0.24	1.12	89.2	9.43	0.5	4.6	13.4	0.5	2.6	15.0	1.0
Po 1st Cl Conc 3	68.0	3.4	0.06	0.71	34.4	64.8	0.19	0.73	88.6	10.5	0.2	2.0	7.1	0.2	0.9	7.9	0.6
Po 1st Cl Conc 4	18.2	0.9	0.06	0.67	33.5	65.8	0.19	0.65	86.3	12.9	0.1	0.5	1.8	0.1	0.2	2.1	0.2
Po 1st Cl Tails	59.4	2.9	0.06	0.40	13.3	86.2	0.16	0.59	33.9	65.4	0.2	1.0	2.4	0.2	0.6	2.6	3.4
Po Ro Tails	1046.7	51.7	<0.01	0.06	0.59	99.3	0.01	0.07	1.5	98.5	0.3	2.5	1.9	0.3	1.3	2.0	89.7
Head (Calc.)	2023.1	100	1.02	1.17	16.4	81.4	2.96	2.70	37.6	56.8	100	100	100	100	100	100	100
Head (Dir.)			1.07	1.17	16.5	81.3	3.10	2.69	37.7	56.5							

0.005 was used for <0.01 calculation

Combined Products	Stage Recovery																			
	Cp	Pn	Po																	
Cu/Ni 1st Cl Conc 1		7.8	11.3	7.85	35.4	45.5	32.8	21.2	44.0	2.0	86.6	52.4	16.9	86.6	61.5	9.2	0.3	88.9	71.9	26.5
Cu/Ni 1st Cl Conc 1-2		11.0	8.85	6.94	35.5	48.7	25.7	18.6	53.1	2.7	94.8	64.8	23.8	94.8	75.3	15.5	0.5	97.4	87.9	44.7
Cu/Ni 1st Cl Conc 1-3		13.4	7.32	6.10	35.7	50.9	21.2	16.1	59.5	3.1	95.9	69.5	29.1	95.9	79.9	21.2	0.7	98.5	93.4	61.3
Cu/Ni Ro Conc 1-3		19.9	4.99	4.50	34.0	56.5	14.5	11.6	65.2	8.7	97.4	76.4	41.4	97.4	85.6	34.6	3.1			
Po 1st Cl Conc 1		14.8	0.10	1.03	35.5	63.4	0.29	1.60	90.6	7.5	1.5	13.0	32.1	1.5	8.8	35.8	2.0	60.8	66.7	56.4
Po 1st Cl Conc 1-2		21.1	0.09	0.98	35.3	63.6	0.28	1.45	90.2	8.1	2.0	17.6	45.5	2.0	11.4	50.7	3.0	82.2	86.5	80.1
Po 1st Cl Conc 1-3		24.5	0.09	0.94	35.2	63.8	0.26	1.36	89.9	8.4	2.2	19.6	52.6	2.2	12.3	58.7	3.6	91.0	93.4	92.6
Po 1st Cl Conc 1-4		25.4	0.09	0.93	35.1	63.9	0.26	1.33	89.8	8.6	2.2	20.1	54.4	2.2	12.5	60.7	3.8	93.4	95.1	95.8
Po Ro Conc 1-3		28.3	0.09	0.88	32.8	66.2	0.25	1.25	84.0	14.5	2.4	21.1	56.8	2.4	13.2	63.4	7.2			
Cu/Ni Ro Conc 1-3&Po Ro Conc 1-3		48.3	2.11	2.37	33.3	62.2	6.13	5.52	76.3	12.1	99.7	97.5	98.1	99.7	98.7	98.0	10.3			
Po Ro Feed		80.1	0.03	0.35	12.0	87.6	0.10	0.49	30.7	68.7	2.6	23.6	58.6	2.6	14.4	65.4	96.9			

Test: F3 **Project:** 18559-01 **Date:** June 25, 2021 **Operator:** Deepak

Purpose: Conduct rougher kinetics test, target ~150 um

Procedure: As outlined below.

Feed: 2kg SN Comp -10 mesh Freezer\SEC-11C

Grind: 18 minutes at 65% solids in 2 kg Rod Mill #3 Comb Prod P₈₀ = 162 µm

Regrind: N/A

Conditions:

Stage	Reagents added, grams per tonne						Time, minutes			pH	ORP, mV
	Lime	CusO4		PAX	MIBC		Grind	Cond.	Froth		
Grind	550			5			18			9.3	135
Cu/Ni Rougher No. 1	0				0			1	1	9.3	135
Cu/Ni Rougher No. 2	0			5	0			1	2	9.2	119
Cu/Ni Rougher No. 3	0			5	0			1	2	9.0	98
Po Rougher No. 1	0			5	0			1	3	natural pH	111
Po Rougher No. 2	0			5	2.5			1	5	natural pH	122
Po Rougher No. 3	0			5	2.5			1	5	natural pH	192
Total	0	0		25	5	0			18		

* Add as required.

Stage	Rougher/Scavenger	Po Rougher	Cu/Ni 1st/2nd Cleaner	Po 1st & 2nd Cl
Flotation Cell	2 kg float cell	2 kg float cell	500g/250g float cell	250g float cell
Speed: r.p.m.	1800	1800	1500/1200	1200

Metallurgical Balance

Product	Weight		Assays, %								% Distribution						
	g	%	Cu	Ni	S	Other	Cp	Pn	Po	Ga	Cu	Ni	S	Cp	Pn	Po	Ga
Cu/Ni Ro Conc 1	128.7	6.4	11.7	6.84	32.8	48.7	33.9	18.5	38.5	9.09	73.8	38.0	12.5	73.8	45.0	6.4	1.0
Cu/Ni Ro Conc 2	184.7	9.2	2.38	3.60	34.4	59.6	6.90	8.95	75.4	8.74	21.5	28.7	18.9	21.5	31.3	18.0	1.4
Cu/Ni Ro Conc 3	133.9	6.7	0.34	1.65	35.5	62.5	0.99	3.35	88.4	7.22	2.2	9.5	14.1	2.2	8.5	15.3	0.9
Po Ro Conc 1	127.8	6.4	0.11	1.23	35.5	63.2	0.32	2.16	90.1	7.45	0.7	6.8	13.5	0.7	5.2	14.8	0.9
Po Ro Conc 2	97.6	4.9	0.07	1.00	35.2	63.7	0.21	1.52	89.9	8.33	0.3	4.2	10.2	0.3	2.8	11.3	0.7
Po Ro Conc 3	69.0	3.4	0.06	1.00	34.7	64.2	0.16	1.54	88.7	9.64	0.2	3.0	7.1	0.2	2.0	7.9	0.6
Po Ro Tails	1264.8	63.0	0.02	0.18	6.30	93.5	0.06	0.22	16.1	83.6	1.2	9.8	23.7	1.2	5.2	26.3	94.5
Head (Calc.)	2006.5	100	1.02	1.16	16.8	81.1	2.95	2.63	38.6	55.8	100	100	100	100	100	100	100
Head (Dir.)			1.07	1.17	16.5	81.3	3.10	2.69	37.7	56.5							

0.005 was used for <0.01 calculation

Combined Products

Cu/Ni Ro Conc 1		6.4	11.7	6.84	32.8	48.7	33.9	18.5	38.5	9.1	73.8	38.0	12.5	73.8	45.0	6.4	1.0
Cu/Ni Ro Conc 1-2		15.6	6.21	4.93	33.7	55.1	18.0	12.9	60.3	8.9	95.3	66.7	31.4	95.3	76.3	24.4	2.5
Cu/Ni Ro Conc 1-3		22.3	4.45	3.95	34.3	57.3	12.9	10.0	68.7	8.4	97.5	76.2	45.5	97.5	84.8	39.6	3.4
Po Ro Conc 1		6.4	0.11	1.23	35.5	63.2	0.32	2.16	90.1	7.5	0.7	6.8	13.5	0.7	5.2	14.8	0.9
Po Ro Conc 1-2		11.2	0.09	1.13	35.4	63.4	0.27	1.88	90.0	7.8	1.0	11.0	23.7	1.0	8.0	26.2	1.6
Po Ro Conc 1-3		14.7	0.09	1.10	35.2	63.6	0.25	1.80	89.7	8.3	1.2	14.0	30.8	1.2	10.1	34.1	2.2
Cu/Ni & Po Ro Conc 1-3		37.0	2.72	2.82	34.6	59.8	7.88	6.75	77.0	8.3	98.8	90.2	76.3	98.8	94.8	73.7	5.5
Po Ro Feed		77.7	0.03	0.35	11.8	87.9	0.1	0.52	30.0	69.4	2.5	23.8	54.5	2.5	15.2	60.4	96.6

Test: F4 **Project:** 18559-01 **Date:** June 25, 2021 **Operator:** Deepak
Purpose: Conduct rougher kinetics test, target ~75 um
Procedure: As outlined below.
Feed: 2kg SN Comp -10 mesh Freezer\SEC-11C
Grind: 54 minutes at 65% solids in 2 kg Rod Mill #3 Comb Prod P₈₀ = 71 µm
Regrind: N/A

Conditions:

Stage	Reagents added, grams per tonne						Time, minutes			pH	ORP, mV
	Lime	CusO4		PAX	MIBC		Grind	Cond.	Froth		
Grind	700			5			54			9.2	2
Cu/Ni Rougher No. 1	0				0			1	1	9.2	2
Cu/Ni Rougher No. 2	0			5	0			1	2	9.0	112
Cu/Ni Rougher No. 3	20			5	0			1	2	9.0	0
Po Rougher No. 1	0			5	0			1	3	natural pH	67
Po Rougher No. 2	0			5	0			1	5	natural pH	137
Po Rougher No. 3	0			5	0			1	5	natural pH	145
Total	20	0		25	0	0			18		

* Add as required.

Stage	Rougher/Scavenger	Po Rougher	Cu/Ni 1st/2nd Cleaner	Po 1st & 2nd Cl
Flotation Cell	2 kg float cell	2 kg float cell	500g/250g float cell	250g float cell
Speed: r.p.m.	1800	1800	1500/1200	1200

Metallurgical Balance

Product	Weight		Assays, %								% Distribution						
	g	%	Cu	Ni	S	Other	Cp	Pn	Po	Ga	Cu	Ni	S	Cp	Pn	Po	Ga
Cu/Ni Ro Conc 1	71.9	3.6	13.4	7.94	31.4	47.3	38.8	21.7	27.7	11.8	47.4	24.5	6.8	47.4	29.2	2.6	0.7
Cu/Ni Ro Conc 2	137.0	6.8	6.05	6.08	32.7	55.2	17.5	16.1	55.2	11.2	40.8	35.7	13.5	40.8	41.4	9.9	1.3
Cu/Ni Ro Conc 3	254.2	12.6	0.59	1.65	33.1	64.7	1.71	3.44	81.5	13.4	7.4	18.0	25.3	7.4	16.4	27.1	3.0
Po Ro Conc 1	253.0	12.5	0.18	0.99	33.6	65.2	0.52	1.55	85.5	12.5	2.2	10.7	25.5	2.2	7.4	28.2	2.8
Po Ro Conc 2	89.2	4.4	0.14	0.81	33.5	65.6	0.41	1.05	85.7	12.8	0.6	3.1	9.0	0.6	1.8	10.0	1.0
Po Ro Conc 3	46.4	2.3	0.12	0.74	31.5	67.6	0.35	0.92	80.7	18.0	0.3	1.5	4.4	0.3	0.8	4.9	0.7
Po Ro Tails	1168.9	57.8	0.02	0.13	4.44	95.4	0.07	0.14	11.3	88.4	1.4	6.5	15.6	1.4	3.1	17.3	90.5
Head (Calc.)	2020.6	100	1.01	1.15	16.5	81.4	2.92	2.64	37.9	56.6	100	100	100	100	100	100	100
Head (Dir.)			1.07	1.17	16.5	81.3	3.10	2.69	37.7	56.5							

Combined Products

Cu/Ni Ro Conc 1		3.6	13.4	7.94	31.4	47.3	38.8	21.7	27.7	11.8	47.4	24.5	6.8	47.4	29.2	2.6	0.7
Cu/Ni Ro Conc 1-2		10.3	8.58	6.72	32.3	52.4	24.9	18.0	45.7	11.4	88.1	60.2	20.2	88.1	70.6	12.5	2.1
Cu/Ni Ro Conc 1-3		22.9	4.19	3.94	32.7	59.2	12.2	10.0	65.3	12.5	95.5	78.2	45.5	95.5	87.0	39.5	5.1
Po Ro Conc 1		12.5	0.18	0.99	33.6	65.2	0.52	1.55	85.5	12.5	2.2	10.7	25.5	2.2	7.4	28.2	2.8
Po Ro Conc 1-2		16.9	0.17	0.94	33.6	65.3	0.49	1.42	85.5	12.5	2.9	13.8	34.5	2.9	9.1	38.2	3.8
Po Ro Conc 1-3		19.2	0.16	0.92	33.3	65.6	0.47	1.36	85.0	13.2	3.1	15.3	38.9	3.1	9.9	43.1	4.5
Cu/Ni & Po Ro Conc 1-3		42.2	2.36	2.56	33.0	62.1	6.83	6.07	74.3	12.8	98.6	93.5	84.4	98.6	96.9	82.7	9.5
Po Ro Feed		77.1	0.06	0.33	11.6	88.0	0.17	0.44	29.7	69.7	4.5	21.8	54.5	4.5	13.0	60.5	94.9

Test: F5 Project: 18559-01 Date: June 25, 2021 Operator: Deepak

Purpose: Conduct open-circuit cleaning test with depressants Na₂SO₃ and DETA

Procedure: As outlined below.

Feed: 2kg SN Comp -10 mesh Freezer\SEC-11C

Grind: 34 minutes at 65% solids in 2 kg Rod Mill # 3 P₈₀ =
 Regrind 12 minutes at 50% solids in 2 kg Rod Mill for Cu/Ni R.Conc P₈₀ = 35 µm
 24 minutes at 50% solids in 2 kg Rod Mill for Po R.Conc P₈₀ = 31 µm

Conditions:

Stage	Reagents added, grams per tonne						Time, minutes			pH	ORP, mV
	Lime	CuSO ₄	Na ₂ SO ₃	DETA	PAX	MIBC*	Grind	Cond.	Froth		
Grind	625				5		34			9.0	73
Cu/Ni Rougher No. 1	0					0		1	1	9.0	73
Cu/Ni Rougher No. 2	0				5	2.5		1	2	9.0	40
Cu/Ni Rougher No. 3	0				5	0		1	2	9.0	93
Regrind (2kg Rod Mill)	150		500	150	1		12			9.6	-50
Cu/Ni 1st Cleaner No.1	0					0		1	2	9.6	-50
Cu/Ni 1st Cleaner No.2	10				1	0		1	2	9.5	19
Cu/Ni 1st Cleaner No.3	10				2	0		1	3	9.5	37
Po Rougher No. 1					5	0		1	3	natural pH	89
Po Rougher No. 2					5	0		1	5	natural pH	140
Po Rougher No. 3					5	0		1	5	natural pH	118
<i>Po Cleaning on Po Ro Con 1-3</i>											
Regrind (2kg Rod Mill)	200		500	150	1		24			9.6	-82
Po 1st Cleaner No.1	0					0		1	2	9.6	-82
Po 1st Cleaner No.2	0				1	0		1	2	9.4	46
Po 1st Cleaner No.3	0				1	0		1	2	9.2	73
Total	370	0	1000	300	32	2.5			31		

* Add as required.

Stage	Rougher/Scavenger	Po Rougher	Cu/Ni 1st/2nd Cleaner	Po 1st & 2nd Cl
Flotation Cell	2 kg float cell	2 kg float cell	500g/250g float cell	250g float cell
Speed: r.p.m.	1800	1800	1500/1200	1200

Metallurgical Balance

Product	Weight		Assays, %								% Distribution						
	g	%	Cu	Ni	S	Other	Cp	Pn	Po	Ga	Cu	Ni	S	Cp	Pn	Po	Ga
Cu/Ni 1st Cl Conc 1	58.9	2.9	23.9	5.69	34.5	35.9	69.3	15.6	13.2	1.86	67.0	14.2	6.1	67.0	17.0	1.0	0.1
Cu/Ni 1st Cl Conc 2	19.3	1.0	21.0	7.75	33.7	37.6	60.9	21.3	13.9	3.89	19.3	6.3	2.0	19.3	7.6	0.4	0.1
Cu/Ni 1st Cl Conc 3	19.2	1.0	5.81	20.9	33.0	40.3	16.8	57.8	20.9	4.50	5.3	17.0	1.9	5.3	20.5	0.5	0.1
Cu/Ni 1st Cl Tails	260.3	12.9	0.33	3.26	33.6	62.8	0.96	7.94	79.6	11.5	4.1	35.9	26.3	4.1	38.1	27.2	2.6
Po 1st Cl Conc 1	23.5	1.2	0.94	2.23	34.4	62.4	2.72	5.04	82.6	9.68	1.1	2.2	2.4	1.1	2.2	2.5	0.2
Po 1st Cl Conc 2	7.0	0.3	1.13	3.67	34.3	60.9	3.28	9.10	78.3	9.31	0.4	1.1	0.7	0.4	1.2	0.7	0.1
Po 1st Cl Conc 3	6.1	0.3	0.77	3.37	34.6	61.3	2.23	8.23	80.8	8.75	0.2	0.9	0.6	0.2	0.9	0.6	0.0
Po 1st Cl Tails	323.2	16.0	0.09	0.87	32.1	66.9	0.27	1.27	82.0	16.4	1.4	11.9	31.2	1.4	7.5	34.8	4.6
Po Ro Tails	1302.3	64.5	0.02	0.19	7.31	92.5	0.06	0.21	18.8	81.0	1.2	10.5	28.7	1.2	5.0	32.1	92.2
Head (Calc.)	2019.8	100	1.04	1.17	16.4	81.3	3.02	2.68	37.7	56.6	100	100	100	100	100	100	100
Head (Dir.)			1.07	1.17	16.5	81.3	3.10	2.69	37.7	56.5							

Combined Products

Product	g	%																Stage Recovery		
			Cu	Ni	S	Other	Cp	Pn	Po	Ga	Cu	Ni	S	Cp	Pn	Po	Ga	Cp	Pn	Po
Cu/Ni 1st Cl Conc 1		2.9	23.9	5.69	34.5	35.9	69.3	15.6	13.2	1.9	67.0	14.2	6.1	67.0	17.0	1.0	0.1	70.0	20.4	3.5
Cu/Ni 1st Cl Conc 1-2		3.9	23.2	6.20	34.3	36.3	67.2	17.0	13.4	2.4	86.3	20.5	8.1	86.3	24.6	1.4	0.2	90.2	29.5	4.7
Cu/Ni 1st Cl Conc 1-3		4.8	19.8	9.10	34.0	37.1	57.3	25.1	14.9	2.8	91.6	37.5	10.0	91.6	45.0	1.9	0.2	95.7	54.1	6.5
Cu/Ni Ro Conc 1-3		17.7	5.62	4.85	33.7	55.8	16.3	12.6	62.0	9.1	95.7	73.4	36.3	95.7	83.2	29.1	2.9			
Po 1st Cl Conc 1		1.2	0.94	2.23	34.4	62.4	2.72	5.04	82.6	9.7	1.1	2.2	2.4	1.1	2.2	2.5	0.2	34.1	18.5	6.6
Po 1st Cl Conc 1-2		1.5	0.98	2.56	34.4	62.1	2.85	5.97	81.6	9.6	1.4	3.3	3.2	1.4	3.4	3.3	0.3	46.3	28.4	8.4
Po 1st Cl Conc 1-3		1.8	0.95	2.70	34.4	61.9	2.75	6.35	81.4	9.5	1.7	4.2	3.8	1.7	4.3	3.9	0.3	53.6	36.2	10.1
Po Ro Conc 1-3		17.8	0.18	1.06	32.3	66.4	0.52	1.78	82.0	15.7	3.1	16.1	35.0	3.1	11.8	38.8	4.9			
Cu/Ni Ro Conc 1-3&Po Ro Conc 1-3		35.5	2.89	2.95	33.0	61.1	8.38	7.18	72.0	12.4	98.8	89.5	71.3	98.8	95.0	67.9	7.8			
Po Ro Feed		82.3	0.05	0.38	12.7	86.8	0.16	0.55	32.4	66.8	4.3	26.6	63.7	4.3	16.8	70.9	97.1			

Test: F6 Project: 18559-01 Date: June 30, 2021 Operator: Deepak

Purpose: Conduct open-circuit cleaning test with depressants Na₂SO₃ only

Procedure: As outlined below.

Feed: 2kg SN Comp -10 mesh Freezer\SEC-11C

Grind: 34 minutes at 65% solids in 2 kg Rod Mill # 3

P₈₀ =

Regrind 12 minutes at 50% solids in 2 kg Rod Mill for Cu/Ni R.Conc

P₈₀ = 49 µm

24 minutes at 50% solids in 2 kg Rod Mill for Po R.Conc

P₈₀ = 41 µm

Assays: Cu, Ni, S

Conditions:

Stage	Reagents added, grams per tonne						Time, minutes			pH	ORP, mV
	Lime	CuSO ₄	Na ₂ SO ₃		PAX	MIBC*	Grind	Cond.	Froth		
Grind	625				5		34			8.8	73
Cu/Ni Rougher No. 1	5					0		1	1	9.0	-151
Cu/Ni Rougher No. 2	35				5	0		1	2	9.0	56
Cu/Ni Rougher No. 3	65				5	0		1	2	9.0	64
Regrind (2kg Rod Mill)	150		500		1		12			9.0	84
Cu/Ni 1st Cleaner No.1	35					0		1	2	9.5	50
Cu/Ni 1st Cleaner No.2	40				1	0		1	2	9.5	84
Cu/Ni 1st Cleaner No.3	40				1	0		1	3	9.5	92
Cu/Ni 1st Cleaner No.4	15				1	0		1	2	9.6	82
Po Rougher No. 1					5	0		1	3	natural pH	83
Po Rougher No. 2					5	0		1	5	natural pH	93
Po Rougher No. 3					5	0		1	5	natural pH	104
<i>Po Cleaning on Po Ro Con 1-3</i>											
Regrind (2kg Rod Mill)	200		500		1		24			8.8	64
Po 1st Cleaner No.1	55					0		1	2	9.0	64
Po 1st Cleaner No.2	25				1	0		1	2	9.0	91
Po 1st Cleaner No.3	5				1	0		1	2	9.0	103
Total	670	0	1000	0	32	0			33		

Check Malvern

Check Malvern

* Add as required.

Stage	Rougher/Scavenger	Po Rougher	Cu/Ni 1st/2nd Cleaner	Po 1st & 2nd Cl
Flotation Cell	2 kg float cell	2 kg float cell	500g/250g float cell	250g float cell
Speed: r.p.m.	1800	1800	1500/1200	1200

Metallurgical Balance

Product	Weight		Assays, %								% Distribution						
	g	%	Cu	Ni	S	Other	Cp	Pn	Po	Ga	Cu	Ni	S	Cp	Pn	Po	Ga
Cu/Ni 1st Cl Conc 1	135.4	6.7	9.91	6.18	35.0	48.9	28.7	16.5	50.7	4.13	64.8	36.2	14.2	64.8	42.3	8.9	0.5
Cu/Ni 1st Cl Conc 2	97.2	4.8	4.95	5.36	35.3	54.4	14.3	14.0	66.7	5.01	23.2	22.5	10.3	23.2	25.7	8.4	0.4
Cu/Ni 1st Cl Conc 3	98.5	4.9	1.21	3.06	35.9	59.8	3.51	7.33	83.8	5.39	5.8	13.0	10.6	5.8	13.7	10.7	0.5
Cu/Ni 1st Cl Conc 4	40.3	2.0	0.31	1.73	36.4	61.6	0.90	3.54	90.7	4.87	0.6	3.0	4.4	0.6	2.7	4.8	0.2
Cu/Ni 1st Cl Tails	217.1	10.7	0.14	0.88	31.9	67.1	0.41	1.30	81.4	16.9	1.5	8.3	20.7	1.5	5.4	23.0	3.2
Po 1st Cl Conc 1	53.4	2.6	0.37	1.61	33.3	64.7	1.07	3.31	82.7	12.9	1.0	3.7	5.3	1.0	3.4	5.7	0.6
Po 1st Cl Conc 2	42.3	2.1	0.35	1.47	33.9	64.3	1.01	2.90	84.6	11.4	0.7	2.7	4.3	0.7	2.3	4.7	0.4
Po 1st Cl Conc 3	23.1	1.1	0.24	<0.01	35.0	64.8	0.70	-1.26	91.4	9.21	0.3	0.0	2.4	0.3	-0.6	2.7	0.2
Po 1st Cl Tails	184.7	9.1	0.13	0.64	28.3	70.9	0.38	0.75	72.5	26.4	1.2	5.1	15.6	1.2	2.6	17.4	4.2
Po Ro Tails	1138.6	56.1	0.02	0.11	3.61	96.3	0.05	0.11	9.2	90.6	1.0	5.4	12.3	1.0	2.4	13.7	89.8
Head (Calc.)	2030.6	100	1.02	1.14	16.5	81.4	2.95	2.60	37.9	56.6	100	100	100	100	100	100	100
Head (Dir.)			1.07	1.17	16.5	81.3	3.10	2.69	37.7	56.5							

0.005 was used for <0.01 calculation

Combined Products

Product	g	%																Stage Recovery		
			Cu	Ni	S	Other	Cp	Pn	Po	Ga	Cu	Ni	S	Cp	Pn	Po	Ga	Cp	Pn	Po
Cu/Ni 1st Cl Conc 1		6.7	9.91	6.18	35.0	48.9	28.7	16.5	50.7	4.13	64.8	36.2	14.2	64.8	42.3	8.9	0.5	67.6	47.1	16.0
Cu/Ni 1st Cl Conc 1-2		11.5	7.84	5.84	35.1	51.2	22.7	15.4	57.4	4.50	88.1	58.7	24.4	88.1	68.0	17.3	0.9	91.8	75.8	31.1
Cu/Ni 1st Cl Conc 1-3		16.3	5.87	5.01	35.4	53.8	17.0	13.0	65.2	4.76	93.8	71.8	35.0	93.8	81.7	28.1	1.4	97.8	91.0	50.3
Cu/Ni 1st Cl Conc 1-4		18.3	5.26	4.66	35.5	54.6	15.3	12.0	68.0	4.77	94.4	74.8	39.4	94.4	84.5	32.8	1.5	98.5	94.0	58.8
Cu/Ni Ro Conc 1-3		29.0	3.37	3.26	34.2	59.2	9.8	8.0	72.9	9.25	95.9	83.1	60.1	95.9	89.8	55.8	4.7			
Po 1st Cl Conc 1		2.6	0.37	1.61	33.3	64.7	1.07	3.31	82.7	12.9	1.0	3.7	5.3	1.0	3.4	5.7	0.6	30.8	43.2	18.8
Po 1st Cl Conc 1-2		4.7	0.36	1.55	33.6	64.5	1.05	3.13	83.5	12.3	1.7	6.4	9.6	1.7	5.7	10.4	1.0	53.9	73.2	34.0
Po 1st Cl Conc 1-3		5.9	0.34	1.25	33.8	64.6	0.98	2.28	85.1	11.7	1.9	6.4	12.0	1.9	5.1	13.1	1.2	62.6	66.1	43.0
Po Ro Conc 1-3		14.9	0.21	0.88	30.5	68.4	0.61	1.35	77.4	20.6	3.1	11.5	27.6	3.1	7.8	30.5	5.4			
Cu/Ni Ro Conc 1-3&Po Ro Conc 1-3		43.9	2.30	2.45	32.9	62.4	6.66	5.77	74.5	13.1	99.0	94.6	87.7	99.0	97.6	86.3	10.2			
Po Ro Feed		71.0	0.06	0.27	9.26	90.4	0.17	0.37	23.6	75.9	4.1	16.9	39.9	4.1	10.2	44.2	95.3			

Test: F7 Project: 18559-01 Date: July 2, 2021 Operator: Deepak

Purpose: Similar to F5, with half Na₂SO₃ and DETA

Procedure: As outlined below.

Feed: 2kg SN Comp -10 mesh Freezer\SEC-11C

Grind: 34 minutes at 65% solids in 2 kg Rod Mill # 3

P₈₀ =

Regrind 12 minutes at 50% solids in 2 kg Rod Mill for Cu/Ni R.Conc

P₈₀ = 32 µm

24 minutes at 50% solids in 2 kg Rod Mill for Po R.Conc

P₈₀ = 37 µm

Conditions:

Stage	Reagents added, grams per tonne						Time, minutes			pH	ORP, mV
	Lime	CuSO ₄	Na ₂ SO ₃	DETA	PAX	MIBC*	Grind	Cond.	Froth		
Grind	625				5		34			9.1	69
Cu/Ni Rougher No. 1	0					0		1	1	9.1	69
Cu/Ni Rougher No. 2	0				5	0		1	2	9.0	84
Cu/Ni Rougher No. 3	5				5	0		1	2	9.0	85
Regrind (2kg Rod Mill)	150		250	75	1		12			9.2	94
Cu/Ni 1st Cleaner No.1	10					0		1	2	9.5	59
Cu/Ni 1st Cleaner No.2	10				1	0		1	2	9.5	103
Cu/Ni 1st Cleaner No.3	25				2	0		1	3	9.5	104
Po Rougher No. 1					5	0		1	3	natural pH	95
Po Rougher No. 2					5	0		1	5	natural pH	103
Po Rougher No. 3					5	0		1	5	natural pH	104
<i>Po Cleaning on Po Ro Con 1-3</i>											
Regrind (2kg Rod Mill)	200		250	75	1		24			9.3	104
Po 1st Cleaner No.1	0					0		1	2	9.3	104
Po 1st Cleaner No.2	5				1	0		1	2	9.0	105
Po 1st Cleaner No.3	5				1	0		1	2	9.0	98
Total	410	0	500	150	32	0			31		

Target pH 9.5

Target pH 9.0

* Add as required.

Stage	Rougher/Scavenger	Po Rougher	Cu/Ni 1st/2nd Cleaner	Po 1st & 2nd Cl
Flotation Cell	2 kg float cell	2 kg float cell	500g/250g float cell	250g float cell
Speed: r.p.m.	1800	1800	1500/1200	1200

Metallurgical Balance

Product	Weight		Assays, %								% Distribution						
	g	%	Cu	Ni	S	Other	Cp	Pn	Po	Ga	Cu	Ni	S	Cp	Pn	Po	Ga
Cu/Ni 1st Cl Conc 1	67.4	3.3	23.9	6.98	34.3	34.8	69.3	19.3	9.61	1.86	78.3	20.7	7.0	78.3	25.1	0.9	0.1
Cu/Ni 1st Cl Conc 2	22.9	1.1	11.7	15.9	33.9	38.5	33.9	43.9	19.6	2.59	13.0	16.0	2.4	13.0	19.4	0.6	0.1
Cu/Ni 1st Cl Conc 3	26.4	1.3	2.37	17.7	34.3	45.6	6.9	48.6	41.2	3.34	3.0	20.6	2.8	3.0	24.8	1.4	0.1
Cu/Ni 1st Cl Tails	290.2	14.3	0.17	1.51	34.6	63.7	0.49	2.98	86.9	9.66	2.4	19.3	30.5	2.4	16.7	33.3	2.4
Po 1st Cl Conc 1	32.9	1.6	0.51	2.10	35.8	61.6	1.48	4.61	87.7	6.22	0.8	3.0	3.6	0.8	2.9	3.8	0.2
Po 1st Cl Conc 2	6.4	0.3	0.95	4.54	34.3	60.2	2.75	11.5	76.7	9.01	0.3	1.3	0.7	0.3	1.4	0.6	0.0
Po 1st Cl Conc 3	10.7	0.5	0.45	2.81	34.1	62.6	1.30	6.66	81.7	10.4	0.2	1.3	1.1	0.2	1.4	1.2	0.1
Po 1st Cl Tails	336.7	16.6	0.06	0.65	32.2	67.1	0.18	0.64	82.9	16.3	1.0	9.6	32.9	1.0	4.2	36.9	4.7
Po Ro Tails	1239.9	61.0	0.01	0.15	5.06	94.8	0.04	0.17	13.0	86.8	0.8	8.2	19.1	0.8	4.2	21.2	92.3
Head (Calc.)	2033.5	100	1.01	1.12	16.2	81.7	2.93	2.55	37.2	57.3	100	100	100	100	100	100	100
Head (Dir.)			1.07	1.17	16.5	81.3	3.10	2.69	37.7	56.5							

																		Stage Recovery		
																		Cp	Pn	Po
Cu/Ni 1st Cl Conc 1		3.3	23.9	6.98	34.3	34.8	69.3	19.3	9.6	1.9	78.3	20.7	7.0	78.3	25.1	0.9	0.1	80.9	29.2	2.4
Cu/Ni 1st Cl Conc 1-2		4.4	20.8	9.24	34.2	35.8	60.3	25.5	12.1	2.0	91.4	36.7	9.4	91.4	44.5	1.4	0.2	94.4	51.7	4.0
Cu/Ni 1st Cl Conc 1-3		5.7	16.6	11.2	34.2	38.0	48.2	30.7	18.7	2.3	94.4	57.3	12.1	94.4	69.2	2.9	0.2	97.5	80.6	8.0
Cu/Ni Ro Conc 1-3		20.0	4.89	4.28	34.5	56.3	14.2	10.9	67.3	7.6	96.8	76.5	42.6	96.8	85.9	36.2	2.6			
Po 1st Cl Conc 1		1.6	0.51	2.10	35.8	61.6	1.48	4.61	87.7	6.2	0.8	3.0	3.6	0.8	2.9	3.8	0.2	34.6	29.6	9.0
Po 1st Cl Conc 1-2		1.9	0.58	2.50	35.6	61.4	1.69	5.74	85.9	6.7	1.1	4.3	4.2	1.1	4.4	4.5	0.2	47.1	44.0	10.5
Po 1st Cl Conc 1-3		2.5	0.55	2.56	35.2	61.6	1.60	5.94	85.0	7.5	1.3	5.6	5.4	1.3	5.7	5.6	0.3	57.0	57.9	13.2
Po Ro Conc 1-3		19.0	0.13	0.90	32.6	66.4	0.36	1.33	83.2	15.1	2.4	15.3	38.3	2.4	9.9	42.5	5.0			
Cu/Ni Ro Conc 1-3&Po Ro Conc 1-3		39.0	2.57	2.63	33.6	61.2	7.45	6.25	75.1	11.2	99.2	91.8	80.9	99.2	95.8	78.8	7.7			
Po Ro Feed		80.0	0.04	0.33	11.6	88.0	0.12	0.45	29.7	69.8	3.2	23.5	57.4	3.2	14.1	63.8	97.4			

Test: F8 Project: 18559-01 Date: July 5, 2021 Operator: Deepak

Purpose: Similar to F5, with 100/50 Na₂SO₃ and DETA

Procedure: As outlined below.

Feed: 2kg SN Comp -10 mesh Freezer\SEC-11C

Grind: 34 minutes at 65% solids in 2 kg Rod Mill # 3

P₈₀ =

Regrind 12 minutes at 50% solids in 2 kg Rod Mill for Cu/Ni R.Conc

P₈₀ = 35 µm

24 minutes at 50% solids in 2 kg Rod Mill for Po R.Conc

P₈₀ = 26 µm

Conditions:

Stage	Reagents added, grams per tonne						Time, minutes			pH	ORP, mV
	Lime	CuSO ₄	Na ₂ SO ₃	DETA	PAX	MIBC*	Grind	Cond.	Froth		
Grind	625				5		34			9.1	25
Cu/Ni Rougher No. 1	0					0		1	1	9.1	25
Cu/Ni Rougher No. 2	5				5	0		1	2	9.0	145
Cu/Ni Rougher No. 3	10				5	0		1	2	9.0	156
Regrind (2kg Rod Mill)	175		100	50	1		12			9.0	157
Cu/Ni 1st Cleaner No.1	50					0		1	2	9.5	96
Cu/Ni 1st Cleaner No.2	5				1	0		1	2	9.5	107
Cu/Ni 1st Cleaner No.3	30				2	0		1	3	9.5	131
Po Rougher No. 1					5	0		1	3	natural pH	169
Po Rougher No. 2					5	2.5		1	5	natural pH	194
Po Rougher No. 3					5	2.5		1	5	natural pH	190
<i>Po Cleaning on Po Ro Con 1-3</i>											
Regrind (2kg Rod Mill)	200		100	50	1		24			9.0	177
Po 1st Cleaner No.1	0					0		1	2	9.0	177
Po 1st Cleaner No.2	25				1	0		1	2	9.0	168
Po 1st Cleaner No.3	40				1	0		1	2	9.0	165
Total	540	0	200	100	32	5			31		

Target pH 9.5

Target pH 9.0

* Add as required.

Stage	Rougher/Scavenger	Po Rougher	Cu/Ni 1st/2nd Cleaner	Po 1st & 2nd Cl
Flotation Cell	2 kg float cell	2 kg float cell	500g/250g float cell	250g float cell
Speed: r.p.m.	1800	1800	1500/1200	1200

Metallurgical Balance

Product	Weight		Assays, %								% Distribution						
	g	%	Cu	Ni	S	Other	Cp	Pn	Po	Ga	Cu	Ni	S	Cp	Pn	Po	Ga
Cu/Ni 1st Cl Conc 1	93.5	4.6	18.8	10.3	33.6	37.3	54.5	28.4	13.4	3.71	85.3	40.8	9.2	85.3	49.4	1.6	0.3
Cu/Ni 1st Cl Conc 2	21.3	1.1	8.10	13.7	34.6	43.6	23.5	37.5	36.3	2.63	8.4	12.4	2.2	8.4	14.9	1.0	0.1
Cu/Ni 1st Cl Conc 3	42.0	2.1	0.77	5.75	37.1	56.4	2.23	14.8	81.6	1.31	1.6	10.2	4.6	1.6	11.6	4.4	0.0
Cu/Ni 1st Cl Tails	288.9	14.3	0.09	1.12	34.9	63.9	0.26	1.87	88.8	9.06	1.2	13.7	29.5	1.2	10.1	32.6	2.3
Po 1st Cl Conc 1	30.6	1.5	0.65	2.56	36.1	60.7	1.88	5.90	87.0	5.22	1.0	3.3	3.2	1.0	3.4	3.4	0.1
Po 1st Cl Conc 2	10.6	0.5	0.65	3.45	35.4	60.5	1.88	8.43	83.0	6.68	0.3	1.6	1.1	0.3	1.7	1.1	0.1
Po 1st Cl Conc 3	13.7	0.7	0.32	2.09	35.1	62.5	0.93	4.60	86.4	8.09	0.2	1.2	1.4	0.2	1.2	1.5	0.1
Po 1st Cl Tails	287.5	14.2	0.08	0.69	33.0	66.2	0.23	0.73	84.9	14.2	1.1	8.4	27.7	1.1	3.9	31.0	3.6
Po Ro Tails	1233.7	61.0	0.02	0.16	5.86	94.0	0.04	0.17	15.0	84.8	0.9	8.4	21.1	0.9	4.0	23.5	93.3
Head (Calc.)	2021.8	100	1.02	1.17	16.9	80.9	2.96	2.66	39.0	55.4	100	100	100	100	100	100	100
Head (Dir.)			1.07	1.17	16.5	81.3	3.10	2.69	37.7	56.5							

																		Stage Recovery		
																		Cp	Pn	Po
Cu/Ni 1st Cl Conc 1		4.6	18.8	10.3	33.6	37.3	54.5	28.4	13.4	3.7	85.3	40.8	9.2	85.3	49.4	1.6	0.3	88.4	57.5	4.0
Cu/Ni 1st Cl Conc 1-2		5.7	16.8	10.9	33.8	38.5	48.7	30.1	17.6	3.5	93.6	53.2	11.3	93.6	64.3	2.6	0.4	97.1	74.8	6.5
Cu/Ni 1st Cl Conc 1-3		7.8	12.5	9.54	34.7	43.3	36.3	26.0	34.8	2.9	95.2	63.4	15.9	95.2	75.9	6.9	0.4	98.7	88.3	17.5
Cu/Ni Ro Conc 1-3		22.0	4.46	4.08	34.8	56.6	12.9	10.4	69.8	6.9	96.5	77.1	45.4	96.5	85.9	39.5	2.7			
Po 1st Cl Conc 1		1.5	0.65	2.56	36.1	60.7	1.88	5.90	87.0	5.2	1.0	3.3	3.2	1.0	3.4	3.4	0.1	36.5	33.3	9.1
Po 1st Cl Conc 1-2		2.0	0.65	2.79	35.9	60.6	1.88	6.55	86.0	5.6	1.3	4.9	4.3	1.3	5.0	4.5	0.2	49.2	49.8	12.2
Po 1st Cl Conc 1-3		2.7	0.57	2.61	35.7	61.1	1.65	6.06	86.1	6.2	1.5	6.1	5.7	1.5	6.2	6.0	0.3	57.2	61.4	16.2
Po Ro Conc 1-3		16.9	0.16	1.00	33.4	65.4	0.46	1.58	85.1	12.9	2.6	14.5	33.5	2.6	10.1	37.0	3.9			
Cu/Ni Ro Conc 1-3&Po Ro Conc 1-3		39.0	2.59	2.74	34.2	60.4	7.51	6.55	76.4	9.5	99.1	91.6	78.9	99.1	96.0	76.5	6.7			
Po Ro Feed		78.0	0.05	0.34	11.9	87.8	0.13	0.48	30.2	69.1	3.5	22.9	54.6	3.5	14.1	60.5	97.3			

Test: F9 Project: 18559-01 Date: July 5, 2021 Operator: Deepak

Purpose: Similar to F5, with 100/25 Na2SO3 and DETA

Procedure: As outlined below.

Feed: 2kg SN Comp -10 mesh Freezer\SEC-11C

Grind: 34 minutes at 65% solids in 2 kg Rod Mill # 3 P₈₀ = 100 µm
 Regrind 12 minutes at 50% solids in 2 kg Rod Mill for Cu/Ni R.Conc P₈₀ = 31 µm
 48 minutes at 50% solids in 2 kg Rod Mill for Po R.Conc P₈₀ = 18 µm

Conditions:

Stage	Reagents added, grams per tonne						Time, minutes			pH	ORP, mV
	Lime	CuSO4	Na2SO3	DETA	PAX	MIBC*	Grind	Cond.	Froth		
Grind	625				5		34			9.1	55
Cu/Ni Rougher No. 1	0					2.5		1	1	9.1	55
Cu/Ni Rougher No. 2	0				5	0		1	2	9.0	140
Cu/Ni Rougher No. 3	15				5	2.5		1	2	9.0	152
Regrind (2kg Rod Mill)	175		100	25	1		12			9.1	160
Cu/Ni 1st Cleaner No.1	15					0		1	2	9.5	136
Cu/Ni 1st Cleaner No.2	25				1	0		1	2	9.5	142
Cu/Ni 1st Cleaner No.3	35				2	0		1	3	9.5	141
Cu/Ni 1st Cleaner No.4	45				2	0		1	3	9.5	143
Po Rougher No. 1					5	0		1	3	natural pH	170
Po Rougher No. 2					5	7.5		1	5	natural pH	179
Po Rougher No. 3					5	0		1	5	natural pH	186
<i>Po Cleaning on Po Ro Con 1-3</i>											
Regrind (2kg Rod Mill)	200		100	25	1		48			8.9	190
Po 1st Cleaner No.1	5					0		1	2	9.0	91
Po 1st Cleaner No.2	45				1	0		1	2	9.0	153
Po 1st Cleaner No.3	5				1	0		1	2	9.0	98
Total	565	0	200	50	34	12.5			34		

Target pH 9.5

Target pH 9.0

* Add as required.

Stage	Rougher/Scavenger	Po Rougher	Cu/Ni 1st/2nd Cleaner	Po 1st & 2nd Cl
Flotation Cell	2 kg float cell	2 kg float cell	500g/250g float cell	250g float cell
Speed: r.p.m.	1800	1800	1500/1200	1200

Metallurgical Balance

Product	Weight		Assays, %								% Distribution									
	g	%	Cu	Ni	S	Other	Cp	Pn	Po	Ga	Cu	Ni	S	Cp	Pn	Po	Ga			
Cu/Ni 1st Cl Conc 1	82.9	4.1	19.2	9.66	33.8	37.3	55.7	26.6	14.4	3.34	77.2	33.4	8.4	77.2	40.0	1.6	0.2			
Cu/Ni 1st Cl Conc 2	23.3	1.1	11.6	13.3	33.9	41.2	33.6	36.6	26.1	3.67	13.1	12.9	2.4	13.1	15.5	0.8	0.1			
Cu/Ni 1st Cl Conc 3	19.6	1.0	2.81	11.4	35.6	50.2	8.14	30.9	58.6	2.38	2.7	9.3	2.1	2.7	11.0	1.5	0.0			
Cu/Ni 1st Cl Conc 4	22.2	1.1	1.10	5.71	36.9	56.3	3.19	14.7	80.3	1.76	1.2	5.3	2.5	1.2	5.9	2.3	0.0			
Cu/Ni 1st Cl Tails	218.6	10.8	0.23	1.41	34.2	64.2	0.67	2.72	85.9	10.7	2.4	12.9	22.4	2.4	10.8	24.6	2.0			
Po 1st Cl Conc 1	50.7	2.5	0.34	1.90	35.2	62.6	0.99	4.06	87.1	7.90	0.8	4.0	5.4	0.8	3.7	5.8	0.3			
Po 1st Cl Conc 2	28.6	1.4	0.40	2.10	35.0	62.5	1.16	4.63	85.9	8.32	0.6	2.5	3.0	0.6	2.4	3.2	0.2			
Po 1st Cl Conc 3	26.9	1.3	0.28	1.66	34.8	63.3	0.81	3.40	86.7	9.05	0.4	1.9	2.8	0.4	1.7	3.1	0.2			
Po 1st Cl Tails	269.9	13.3	0.10	0.72	31.5	67.7	0.29	0.86	80.8	18.0	1.3	8.1	25.5	1.3	4.2	28.6	4.2			
Po Ro Tails	1289.7	63.5	<0.01	0.18	6.59	93.2	0.01	0.21	16.9	82.9	0.3	9.7	25.5	0.3	4.8	28.6	92.6			
Head (Calc.)	2032.4	100	1.01	1.18	16.4	81.4	2.94	2.71	37.6	56.8	100	100	100	100	100	100	100			
Head (Dir.)			1.07	1.17	16.5	81.3	3.10	2.69	37.7	56.5										
0.005 was used for <0.01 calculation																				
Combined Products																		Stage Recovery		
																		Cp	Pn	Po
Cu/Ni 1st Cl Conc 1	82.9	4.1	19.2	9.66	33.8	37.3	55.7	26.6	14.4	3.34	77.2	33.4	8.4	77.2	40.0	1.6	0.2	79.9	48.1	5.1
Cu/Ni 1st Cl Conc 1-2	106.2	5.2	17.5	10.5	33.8	38.2	50.8	28.8	17.0	3.41	90.3	46.3	10.8	90.3	55.5	2.4	0.3	93.5	66.7	7.7
Cu/Ni 1st Cl Conc 1-3	125.8	6.2	15.2	10.6	34.1	40.1	44.2	29.1	23.4	3.25	93.0	55.7	12.9	93.0	66.5	3.9	0.4	96.2	79.9	12.5
Cu/Ni 1st Cl Conc 1-4	148.0	7.3	13.1	9.87	34.5	42.5	38.0	27.0	32.0	3.03	94.2	61.0	15.3	94.2	72.4	6.2	0.4	97.5	87.1	20.1
Cu/Ni Ro Conc 1-3	366.6	18.0	5.43	4.83	34.3	55.4	15.7	12.5	64.1	7.62	96.6	73.8	37.8	96.6	83.2	30.8	2.4			
Po 1st Cl Conc 1	50.7	2.5	0.34	1.90	35.2	62.6	0.99	4.06	87.1	7.9	0.8	4.0	5.4	0.8	3.7	5.8	0.3	27.3	31.1	14.2
Po 1st Cl Conc 1-2	79.3	3.9	0.36	1.97	35.1	62.5	1.05	4.27	86.6	8.1	1.4	6.5	8.4	1.4	6.1	9.0	0.6	45.4	51.0	22.1
Po 1st Cl Conc 1-3	106.2	5.2	0.34	1.89	35.0	62.7	0.99	4.05	86.7	8.3	1.8	8.4	11.2	1.8	7.8	12.1	0.8	57.3	64.8	29.7
Po Ro Conc 1-3	376.1	18.5	0.17	1.05	32.5	66.3	0.49	1.76	82.5	15.3	3.1	16.5	36.7	3.1	12.0	40.6	5.0			
Cu/Ni Ro Conc 1-3&Po Ro C	742.7	36.5	2.77	2.91	33.4	60.9	8.02	7.07	73.4	11.5	99.7	90.3	74.5	99.7	95.2	71.4	7.4			
Po Ro Feed	1665.8	82.0	0.04	0.38	12.4	87.1	0.12	0.56	31.7	67.6	3.4	26.2	62.2	3.4	16.8	69.2	97.6			

Test: F10 Project: 18559-01 Date: July 6, 2021 Operator: Deepak

Purpose: Similar to F9, with 100/10 Na2SO3 and DETA

Procedure: As outlined below.

Feed: 2kg SN Comp -10 mesh Freezer\SEC-11C

Grind: 34 minutes at 65% solids in 2 kg Rod Mill # 3

P₈₀ =

Regrind 12 minutes at 50% solids in 2 kg Rod Mill for Cu/Ni R.Conc

P₈₀ = 31 µm

5 minutes at 50% solids in Attrition Mill for Po R.Conc - stainless steel

P₈₀ = 28 µm

Conditions:

Stage	Reagents added, grams per tonne						Time, minutes			pH	ORP, mV
	Lime	CuSO4	Na2SO3	DETA	PAX	MIBC*	Grind	Cond.	Froth		
Grind	625				5		34			9.0	122
Cu/Ni Rougher No. 1	0					0		1	1	9.0	122
Cu/Ni Rougher No. 2	10				5	0		1	2	9.0	146
Cu/Ni Rougher No. 3	15				5	0		1	2	9.0	151
Regrind (2kg Rod Mill)	175		100	10	1		12			9.1	153
Cu/Ni 1st Cleaner No.1	25					0		1	2	9.5	136
Cu/Ni 1st Cleaner No.2	15				1	0		1	2	9.5	149
Cu/Ni 1st Cleaner No.3	30				2	0		1	3	9.5	145
Cu/Ni 1st Cleaner No.4	30				2	0		1	3	9.5	148
Po Rougher No. 1					5	2.5		1	3	natural pH	160
Po Rougher No. 2					5	5		1	5	natural pH	192
Po Rougher No. 3					5	5		1	5	natural pH	204
<i>Po Cleaning on Po Ro Con 1-3, Split to two, each put in Attrition Mill.</i>											
Regrind (Attrition Mill)	175		100	10	1		5			8.8	157
Po 1st Cleaner No.1	55					0		1	2	9.0	157
Po 1st Cleaner No.2	55				1	0		1	2	9.0	180
Po 1st Cleaner No.3	35				1	0		1	2	9.0	180
Total	620	0	200	20	34	12.5			34		

Target pH 9.5

Target P80 ~35 um

Target pH 9.0

Target P80 ~15-20 um

* Add as required.

Stage	Rougher/Scavenger	Po Rougher	Cu/Ni 1st/2nd Cleaner	Po 1st & 2nd Cl
Flotation Cell	2 kg float cell	2 kg float cell	500g/250g float cell	250g float cell
Speed: r.p.m.	1800	1800	1500/1200	1200

Metallurgical Balance

Product	Weight		Assays, %								% Distribution									
	g	%	Cu	Ni	S	Other	Cp	Pn	Po	Ga	Cu	Ni	S	Cp	Pn	Po	Ga			
Cu/Ni 1st Cl Conc 1	115.9	5.8	13.8	8.07	34.7	43.4	40.0	21.9	35.0	3.10	79.0	40.5	12.4	79.0	48.0	5.5	0.3			
Cu/Ni 1st Cl Conc 2	36.8	1.8	6.51	8.56	34.8	50.1	18.9	23.0	53.5	4.60	11.8	13.7	4.0	11.8	16.0	2.7	0.1			
Cu/Ni 1st Cl Conc 3	42.4	2.1	1.47	4.83	35.6	58.1	4.26	12.3	78.0	5.38	3.1	8.9	4.7	3.1	9.9	4.5	0.2			
Cu/Ni 1st Cl Conc 4	34.5	1.7	0.55	2.50	36.5	60.5	1.59	5.71	88.5	4.23	0.9	3.7	3.9	0.9	3.7	4.1	0.1			
Cu/Ni 1st Cl Tails	140.5	7.0	0.26	1.23	31.9	66.6	0.75	2.29	80.2	16.7	1.8	7.5	13.8	1.8	6.1	15.2	2.0			
Po 1st Cl Conc 1	40.4	2.0	0.35	1.95	33.8	63.9	1.01	4.25	83.2	11.5	0.7	3.4	4.2	0.7	3.2	4.5	0.4			
Po 1st Cl Conc 2	30.8	1.5	0.34	1.83	33.7	64.1	0.99	3.92	83.3	11.8	0.5	2.4	3.2	0.5	2.3	3.5	0.3			
Po 1st Cl Conc 3	30.3	1.5	0.31	1.77	34.2	63.7	0.90	3.73	84.8	10.6	0.5	2.3	3.2	0.5	2.1	3.5	0.3			
Po 1st Cl Tails	276.2	13.7	0.07	0.73	31.2	68.0	0.19	0.90	80.1	18.8	0.9	8.7	26.6	0.9	4.7	29.8	4.5			
Po Ro Tails	1263.4	62.8	0.01	0.16	6.16	93.7	0.04	0.16	15.8	84.0	0.8	8.8	24.0	0.8	3.9	26.9	91.7			
Head (Calc.)	2011.2	100	1.01	1.15	16.1	81.7	2.92	2.63	36.9	57.5	100	100	100	100	100	100	100			
Head (Dir.)			1.07	1.17	16.5	81.3	3.10	2.69	37.7	56.5										
0.005 was used for <0.01 calculation																				
Combined Products																		Stage Recovery		
																		Cp	Pn	Po
Cu/Ni 1st Cl Conc 1		5.8	13.8	8.07	34.7	43.4	40.0	21.9	35.0	3.10	79.0	40.5	12.4	79.0	48.0	5.5	0.3	81.7	57.4	17.1
Cu/Ni 1st Cl Conc 1-2		7.6	12.0	8.19	34.7	45.0	34.9	22.2	39.4	3.46	90.8	54.2	16.4	90.8	64.0	8.1	0.5	94.0	76.5	25.5
Cu/Ni 1st Cl Conc 1-3		9.7	9.75	7.46	34.9	47.9	28.2	20.1	47.8	3.88	93.9	63.1	21.0	93.9	73.9	12.6	0.7	97.2	88.3	39.4
Cu/Ni 1st Cl Conc 1-4		11.4	8.36	6.71	35.2	49.8	24.2	17.9	53.9	3.93	94.8	66.8	24.9	94.8	77.6	16.7	0.8	98.1	92.7	52.4
Cu/Ni Ro Conc 1-3		18.4	5.29	4.63	33.9	56.2	15.3	12.0	63.9	8.80	96.6	74.3	38.8	96.6	83.7	31.8	2.8			
Po 1st Cl Conc 1		2.0	0.35	1.95	33.8	63.9	1.01	4.25	83.2	11.5	0.7	3.4	4.2	0.7	3.2	4.5	0.4	27.1	26.2	11.0
Po 1st Cl Conc 1-2		3.5	0.35	1.90	33.8	64.0	1.00	4.11	83.2	11.6	1.2	5.9	7.4	1.2	5.5	8.0	0.7	47.1	44.7	19.4
Po 1st Cl Conc 1-3		5.0	0.34	1.86	33.9	63.9	0.97	4.00	83.7	11.3	1.7	8.2	10.6	1.7	7.7	11.4	1.0	65.1	62.0	27.8
Po Ro Conc 1-3		18.8	0.14	1.03	31.9	66.9	0.40	1.73	81.1	16.8	2.6	16.9	37.2	2.6	12.4	41.2	5.5			
Cu/Ni Ro Conc 1-3&Po Ro Conc 1-3		37.2	2.69	2.81	32.9	61.6	7.79	6.80	72.6	12.8	99.2	91.2	76.0	99.2	96.1	73.1	8.3			
Po Ro Feed		81.6	0.04	0.36	12.1	87.5	0.12	0.53	30.8	68.5	3.4	25.7	61.2	3.4	16.3	68.2	97.2			

Test: F11 Project: 18559-01 Date: July 6, 2021 Operator: Deepak

Purpose: Similar to F9, with 100/10 Na₂SO₃ and DETA

Procedure: As outlined below.

Feed: 2kg SN Comp -10 mesh Freezer\SEC-11C

Grind: 20 minutes at 65% solids in 2 kg Rod Mill # 3

P₈₀ =

Regrind 12 minutes at 50% solids in 2 kg Rod Mill for Cu/Ni R.Conc

P₈₀ = 30 µm

15 minutes at 50% solids in Attrition Mill for Po R.Conc

P₈₀ = 17 µm

Conditions:

Stage	Reagents added, grams per tonne						Time, minutes			pH	ORP, mV	
	Lime	CuSO ₄	Na ₂ SO ₃	DETA	PAX	MIBC*	Grind	Cond.	Froth			
Grind	625				5		20			9.3	150	
Cu/Ni Rougher No. 1	0					5		1	1	9.3	158	
Cu/Ni Rougher No. 2	0				5	0		1	2	9.1	150	
Cu/Ni Rougher No. 3	0				5	0		1	2	9.0	172	
Regrind (2kg Rod Mill)	175		100	10	1		12			8.9	198	Target pH 9.5
Cu/Ni 1st Cleaner No.1	15					0		1	2	9.5	142	Target P80 ~35 um
Cu/Ni 1st Cleaner No.2	25				3	0		1	3	9.5	143	
Cu/Ni 1st Cleaner Scav	45				3			1	5	9.5	144	
Cu/Ni 2nd Cleaner	10				0	0		1	4	9.5	137	Target pH 9.5
Cu/Ni 3rd Cleaner	10				0	0		1	4	9.5	152	Target pH 9.5
Po Rougher No. 1					5	2.5		1	3	natural pH	190	
Po Rougher No. 2					5	5		1	5	natural pH	189	
Po Rougher No. 3					5	10		1	5	natural pH	200	
<i>Po Cleaning on Po Ro Con 1-3</i>												
Regrind (Attrition Mill)	300		100	50	1		15			10.5	56	Target pH 9.0 Target P80 ~15-20 um
Po 1st Cleaner No.1	0					0		1	2	10.5	56	
Po 1st Cleaner No.2	10				1	0		1	2	9.0	164	
Po 1st Cleaner No.3	5				1	0		1	2	9.0	98	
Total	595	0	200	60	35	22.5			42			

* Add as required.

Stage	Rougher/Scavenger	Po Rougher	Cu/Ni 1st/2nd Cleaner	Po 1st & 2nd Cl
Flotation Cell	2 kg float cell	2 kg float cell	500g/250g float cell	250g float cell
Speed: r.p.m.	1800	1800	1500/1200	1200

Metallurgical Balance

Product	Weight		Assays, %								% Distribution									
	g	%	Cu	Ni	S	Other	Cp	Pn	Po	Ga	Cu	Ni	S	Cp	Pn	Po	Ga			
Cu/Ni 3rd Cl Conc 1	77.0	3.8	22.1	9.51	33.4	35.0	64.1	26.3	5.9	3.66	84.2	32.1	7.9	84.2	38.9	0.6	0.2			
Cu/Ni 3rd Cl Tails	8.3	0.4	5.77	12.7	34.6	46.9	16.7	34.7	45.0	3.66	2.4	4.6	0.9	2.4	5.5	0.5	0.0			
Cu/Ni 2nd Cl Tails	19.1	0.9	2.55	7.73	34.6	55.1	7.39	20.6	65.5	6.52	2.4	6.5	2.0	2.4	7.5	1.7	0.1			
Cu/Ni 1st Cl Scav Conc	22.8	1.1	3.18	8.22	35.5	53.1	9.22	21.9	65.0	3.82	3.6	8.2	2.5	3.6	9.6	2.0	0.1			
Cu/Ni 1st Cl Scav Tails	154.8	7.7	0.63	1.87	32.7	64.8	1.83	4.08	79.8	14.3	4.8	12.7	15.5	4.8	12.1	16.5	1.9			
Po 1st Cl Conc 1	36.7	1.8	0.32	2.34	33.1	64.2	0.93	5.37	80.5	13.2	0.6	3.8	3.7	0.6	3.8	3.9	0.4			
Po 1st Cl Conc 2	16.3	0.8	0.30	1.90	34.0	63.8	0.87	4.10	84.0	11.0	0.2	1.4	1.7	0.2	1.3	1.8	0.2			
Po 1st Cl Conc 3	8.2	0.4	0.34	2.40	34.3	63.0	0.99	5.50	83.5	10.03	0.1	0.9	0.9	0.1	0.9	0.9	0.1			
Po 1st Cl Tails	213.3	10.6	0.12	1.23	33.2	65.5	0.35	2.24	84.0	13.4	1.3	11.5	21.7	1.3	9.2	23.9	2.5			
Po Ro Tails	1454.2	72.3	<0.01	0.29	9.68	90.0	0.01	0.41	24.8	74.8	0.4	18.5	43.2	0.4	11.4	48.1	94.5			
Head (Calc.)	2010.7	100	1.00	1.14	16.2	81.6	2.91	2.60	37.2	57.3	100	100	100	100	100	100	100			
Head (Dir.)			1.07	1.17	16.5	81.3	3.10	2.69	37.7	56.5										
0.005 was used for <0.01 calculation																				
Combined Products																		Stage Recovery		
																		Cp	Pn	Po
Cu/Ni 3rd Cl Conc		3.8	22.1	9.51	33.4	35.0	64.1	26.3	5.95	3.66	84.2	32.1	7.9	84.2	38.9	0.6	0.2	86.5	52.8	2.9
Cu/Ni 2nd Cl Conc		4.2	20.5	9.82	33.5	36.2	59.5	27.1	9.75	3.66	86.6	36.7	8.8	86.6	44.4	1.1	0.3	88.9	60.3	5.2
Cu/Ni 1st Cl Conc		5.2	17.2	9.44	33.7	39.6	49.9	25.9	20.0	4.18	89.0	43.2	10.8	89.0	51.9	2.8	0.4	91.4	70.5	13.1
Cu/Ni 1st Cl & Scav Conc		6.3	14.7	9.22	34.0	42.0	42.6	25.2	28.0	4.12	92.6	51.4	13.3	92.6	61.5	4.8	0.5	95.0	83.6	22.4
Cu/Ni Ro Conc 1-3		14.0	6.98	5.19	33.3	54.5	20.2	13.6	56.4	9.72	97.4	64.1	28.8	97.4	73.6	21.3	2.4			
Po 1st Cl Conc 1		1.8	0.32	2.34	33.1	64.2	0.93	5.37	80.5	13.2	0.6	3.8	3.7	0.6	3.8	3.9	0.4	26.1	25.1	12.9
Po 1st Cl Conc 1-2		2.6	0.31	2.20	33.4	64.1	0.91	4.98	81.6	12.5	0.8	5.1	5.4	0.8	5.1	5.8	0.6	36.9	33.5	18.9
Po 1st Cl Conc 1-3		3.0	0.32	2.23	33.5	64.0	0.92	5.05	81.8	12.2	1.0	6.0	6.3	1.0	5.9	6.7	0.6	43.1	39.3	21.8
Po Ro Conc 1-3		13.7	0.16	1.45	33.3	65.1	0.48	2.87	83.5	13.1	2.2	17.5	28.0	2.2	15.1	30.6	3.1			
Cu/Ni Ro Conc 1-3&Po Ro Conc 1-3		27.7	3.62	3.34	33.3	59.8	10.5	8.31	69.8	11.4	99.6	81.5	56.8	99.6	88.6	51.9	5.5			
Po Ro Feed		86.0	0.03	0.47	13.4	86.1	0.09	0.80	34.1	65.0	2.6	35.9	71.2	2.6	26.4	78.7	97.6			

Test: F12 **Project:** 18559-01 **Date:** July 12, 2021 **Operator:** Deepak

Purpose: Similar to F9, with 0/25 Na2SO3 and DETA

Procedure: As outlined below.

Feed: 2kg SN Comp -10 mesh Freezer/SEC-11C

Grind: 34 minutes at 65% solids in 2 kg Rod Mill # 3 P₈₀ =
Regrind 12 minutes at 50% solids in 2 kg Rod Mill for Cu/Ni R.Conc Cu/Ni Cl Tails P₈₀ = 45 µm
 48 minutes at 50% solids in 2 kg Rod Mill for Po R.Conc Po Cl Tails P₈₀ = 30 µm

Note:

Conditions:

Stage	Reagents added, grams per tonne						Time, minutes			pH	ORP, mV
	Lime	CuSO4	Na2SO3	DETA	PAX	MIBC*	Grind	Cond.	Froth		
Grind	625				5		34			8.9	121
Cu/Ni Rougher No. 1	15					0		1	1	9.0	92
Cu/Ni Rougher No. 2	10				5	0		1	2	9.0	160
Cu/Ni Rougher No. 3	15				5	5		1	2	9.0	170
Regrind (2kg Rod Mill)	175		0	25	1		12			9.0	46
Cu/Ni 1st Cleaner No.1	30					0		1	2	9.5	104
Cu/Ni 1st Cleaner No.2	20				2	0		1	2	9.5	156
Cu/Ni 1st Cleaner No.3	40				3	0		1	3	9.5	156
Cu/Ni 1st Cleaner No.4	30				3	0		1	3	9.5	158
Po Rougher No. 1					5	0		1	3	natural pH	202
Po Rougher No. 2					5	5		1	5	natural pH	212
Po Rougher No. 3					5	5		1	5	natural pH	225
<i>Po Cleaning on Po Ro Con 1-3</i>											
Regrind (2kg Rod Mill)	200		0	25	1		48			9.0	171
Po 1st Cleaner No.1	0					0		1	2	9.0	171
Po 1st Cleaner No.2	40				3	0		1	2	9.0	173
Po 1st Cleaner No.3	35				10	0		1	2	9.0	176
Po 1st Cleaner Scavenger	0				30	0		1	2		
Po 2nd Cleaner	30				0	0		1	3	9.5	136
Po 3rd Cleaner	10				0	0		1	2	9.5	156
Total	650	0	0	50	78	15			41		

Target pH 9.5

Target pH 9.0

* Add as required.

Stage	Rougher/Scavenger	Po Rougher	Cu/Ni 1st/2nd Cleaner	Po 1st & 2nd Cl
Flotation Cell	2 kg float cell	2 kg float cell	500g/250g float cell	250g float cell
Speed: r.p.m.	1800	1800	1500/1200	1200

Metallurgical Balance

Product	Weight		Assays, %								% Distribution									
	g	%	Cu	Ni	S	Other	Cp	Pn	Po	Ga	Cu	Ni	S	Cp	Pn	Po	Ga			
Cu/Ni 1st Cl Conc 1	119.1	5.9	13.5	8.87	35.0	42.6	39.1	24.2	34.6	2.08	76.5	44.5	12.4	76.5	52.9	5.4	0.2			
Cu/Ni 1st Cl Conc 2	49.4	2.4	5.92	7.60	35.7	50.8	17.2	20.3	59.7	2.82	13.9	15.8	5.3	13.9	18.4	3.8	0.1			
Cu/Ni 1st Cl Conc 3	74.2	3.6	1.05	3.18	36.8	59.0	3.04	7.63	86.3	3.05	3.7	9.9	8.2	3.7	10.4	8.3	0.2			
Cu/Ni 1st Cl Conc 4	58.8	2.9	0.23	1.50	37.1	61.2	0.67	2.87	93.3	3.17	0.6	3.7	6.5	0.6	3.1	7.1	0.2			
Cu/Ni 1st Cl Tails	204.3	10.0	0.10	0.76	32.5	66.6	0.29	0.94	83.3	15.4	1.0	6.5	19.8	1.0	3.5	22.2	2.7			
Po 3rd Cl Conc	22.7	1.1	0.84	3.14	37.0	59.0	2.43	7.51	87.5	2.60	0.9	3.0	2.5	0.9	3.1	2.6	0.1			
Po 3rd Cl Tails	21.2	1.0	0.29	1.49	34.8	63.4	0.84	2.92	87.1	9.12	0.3	1.3	2.2	0.3	1.1	2.4	0.2			
Po 2nd Cl Tails	65.6	3.2	0.16	0.94	32.2	66.7	0.46	1.46	82.0	16.1	0.5	2.6	6.3	0.5	1.8	7.0	0.9			
Po 1st Cl Scav Conc	29.9	1.5	0.18	0.85	33.4	65.6	0.52	1.17	85.3	13.0	0.3	1.1	3.0	0.3	0.6	3.3	0.3			
Po 1st Cl Tails	182.9	9.0	0.09	0.56	28.9	70.4	0.27	0.50	74.4	24.8	0.8	4.3	15.8	0.8	1.7	17.7	3.9			
Po Ro Tails	1206.9	59.3	0.03	0.14	5.00	94.8	0.07	0.15	12.8	87.0	1.4	7.1	18.0	1.4	3.3	20.1	91.2			
Head (Calc.)	2035.0	100	1.03	1.17	16.5	81.3	2.99	2.67	37.7	56.6	100	100	100	100	100	100	100			
Head (Dir.)			1.07	1.17	16.5	81.3	3.10	2.69	37.7	56.5										
Combined Products																	Stage Recovery			
																		Cp	Pn	Po
Cu/Ni 1st Cl Conc 1		5.9	13.5	8.87	35.0	42.6	39.1	24.2	34.6	2.08	76.5	44.5	12.4	76.5	52.9	5.4	0.2	79.9	59.9	11.5
Cu/Ni 1st Cl Conc 1-2		8.3	11.3	8.50	35.2	45.0	32.7	23.0	42.0	2.30	90.5	60.3	17.7	90.5	71.3	9.2	0.3	94.4	80.7	19.7
Cu/Ni 1st Cl Conc 1-3		11.9	8.15	6.87	35.7	49.3	23.6	18.3	55.5	2.53	94.2	70.3	25.9	94.2	81.7	17.5	0.5	98.3	92.5	37.4
Cu/Ni 1st Cl Conc 1-4		14.8	6.61	5.82	36.0	51.6	19.1	15.3	62.9	2.65	94.8	74.0	32.4	94.8	84.8	24.7	0.7	99.0	96.0	52.7
Cu/Ni Ro Conc 1-3		24.9	3.98	3.78	34.6	57.7	11.5	9.5	71.2	7.81	95.8	80.6	52.2	95.8	88.3	46.9	3.4			
Po 3rd Cl Conc		1.1	0.84	3.14	37.0	59.0	2.43	7.51	87.5	2.60	0.9	3.0	2.5	0.9	3.1	2.6	0.1	32.8	37.4	7.8
Po 2nd Cl Conc		2.2	0.57	2.34	35.9	61.1	1.66	5.29	87.3	5.75	1.2	4.3	4.7	1.2	4.3	5.0	0.2	43.4	51.0	15.1
Po 1st Cl Conc		5.4	0.33	1.50	33.7	64.5	0.95	3.00	84.1	12.0	1.7	6.9	11.0	1.7	6.0	12.0	1.1	61.5	72.1	36.3
Po 1st Cl & Cl Scav Conc		6.9	0.29	1.36	33.6	64.7	0.85	2.60	84.4	12.2	2.0	8.0	14.0	2.0	6.7	15.3	1.5			
Po Ro Conc 1-3		15.8	0.18	0.91	30.9	68.0	0.52	1.41	78.7	19.4	2.8	12.3	29.8	2.8	8.4	33.0	5.4			
Cu/Ni Ro Conc 1-3&Po Ro Conc 1-3		40.7	2.50	2.66	33.2	61.7	7.25	6.35	74.1	12.3	98.6	92.9	82.0	98.6	96.7	79.9	8.8			
Po Ro Feed		75.1	0.06	0.30	10.5	89.2	0.17	0.41	26.7	72.7	4.2	19.4	47.8	4.2	11.7	53.1	96.6			

Test: F13 Project: 18559-01 Date: July 12, 2021 Operator: Deepak

Purpose: Similar to F9, with 0/25 Na2SO3 and DETA

Procedure: As outlined below.

Feed: 2kg SN Comp -10 mesh Freezer\SEC-11C

Grind: 34 minutes at 65% solids in 2 kg Rod Mill # 3
 Regrind 12 minutes at 50% solids in 2 kg Rod Mill for Cu/Ni R.Conc Cu/Ni Cl Feed P₈₀ = 33 µm
 7.5 minutes at 50% solids in Attrition Mill for Po R.Conc Po Cl Feed P₈₀ = 21 µm

Note: Request Po Ro Tails S/A

Conditions:

Stage	Reagents added, grams per tonne						Time, minutes			pH	ORP, mV
	Lime	CuSO4	Na2SO3	DETA	PAX	MIBC*	Grind	Cond.	Froth		
Grind	625				5		34			9.0	164
Cu/Ni Rougher No. 1	0					2.5		1	1	9.0	164
Cu/Ni Rougher No. 2	10				5	0		1	2	9.0	168
Cu/Ni Rougher No. 3	10				5	0		1	2	9.0	174
Po Rougher No. 1	-				10	0		1	3	natural pH	175
Po Rougher No. 2	-				10	5		1	3	natural pH	222
Regrind Comb Ro Conc(2kg Rod Mill)	200		0	25	1		12			9.3	175
Cu/Ni 1st Cleaner No.1	5					0		1	2	9.5	147
Cu/Ni 1st Cleaner No.2	30				2	0		1	2	9.5	152
Cu/Ni 1st Cleaner No.3	25				3	0		1	3	9.5	154
Cu/Ni 1st Cleaner No.4	25				5	0		1	3	9.5	146
<i>Po Cleaning on Cu/Ni Cleaner Tails</i>											
Regrind (Attrition Mill)	200		0	10			7.5			9.5	165
Po 1st Cleaner No.1	0				15	0		1	3	9.5	165
Po 1st Cleaner No.2	40				40	0		1	3	9.5	179
Total	545	0	0	35	96	7.5			27		

Target pH 9.5

* Add as required.

Stage	Rougher/Scavenger	Po Rougher	Cu/Ni 1st/2nd Cleaner	Po 1st & 2nd Cl
Flotation Cell	2 kg float cell	2 kg float cell	500g/250g float cell	250g float cell
Speed: r.p.m.	1800	1800	1500/1200	1200

Metallurgical Balance

Product	Weight		Assays, %								% Distribution								Stage Recovery		
	g	%	Cu	Ni	S	Other	Cp	Pn	Po	Ga	Cu	Ni	S	Cp	Pn	Po	Ga				
Cu/Ni 1st Cl Conc 1	153.0	7.7	11.4	7.74	35.7	45.2	33.0	20.9	44.8	1.29	85.0	52.3	16.4	85.0	62.1	8.9	0.2				
Cu/Ni 1st Cl Conc 2	89.0	4.5	2.44	4.37	36.5	56.7	7.07	11.0	78.9	2.97	10.6	17.2	9.8	10.6	19.1	9.2	0.2				
Cu/Ni 1st Cl Conc 3	94.3	4.7	0.36	1.83	37.8	60.0	1.04	3.78	94.0	1.18	1.7	7.6	10.7	1.7	6.9	11.6	0.1				
Cu/Ni 1st Cl Conc 4	72.6	3.6	0.11	1.08	37.7	61.1	0.32	1.66	96.2	1.81	0.4	3.5	8.2	0.4	2.3	9.1	0.1				
Po 1st Cl Conc 1	38.6	1.9	0.11	1.16	34.2	64.5	0.32	2.01	86.8	10.9	0.2	2.0	4.0	0.2	1.5	4.4	0.4				
Po 1st Cl Conc 2	20.7	1.0	0.10	1.12	35.7	63.1	0.29	1.84	90.9	6.98	0.1	1.0	2.2	0.1	0.7	2.5	0.1				
Po 1st Cl Tails	217.3	10.9	0.04	0.57	31.3	68.1	0.10	0.45	80.8	18.6	0.4	5.5	20.4	0.4	1.9	22.9	3.6				
Po Ro Tails	1312.1	65.7	0.03	0.19	7.2	92.6	0.08	0.21	18.3	81.4	1.7	11.0	28.2	1.7	5.5	31.4	95.3				
Head (Calc.)	1997.6	100	1.03	1.13	16.7	81.2	2.98	2.58	38.3	56.1	100	100	100	100	100	100	100				
Head (Dir.)			1.07	1.17	16.5	81.3	3.10	2.69	37.7	56.5											
Combined Products																		Stage Recovery			
																		Cp	Pn	Po	
Cu/Ni 1st Cl Conc 1		7.7	11.4	7.74	35.7	45.2	33.0	20.9	44.8	1.29	85.0	52.3	16.4	85.0	62.1	8.9	0.2				
Cu/Ni 1st Cl Conc 1-2		12.1	8.10	6.50	36.0	49.4	23.5	17.3	57.3	1.91	95.5	69.4	26.2	95.5	81.1	18.1	0.4				
Cu/Ni 1st Cl Conc 1-3		16.8	5.93	5.19	36.5	52.4	17.2	13.5	67.6	1.70	97.2	77.1	36.9	97.2	88.1	29.7	0.5				
Cu/Ni 1st Cl Conc 1-4		20.5	4.90	4.46	36.7	53.9	14.2	11.4	72.7	1.72	97.6	80.5	45.1	97.6	90.4	38.8	0.6				
Po 1st Cl Conc 1		1.9	0.11	1.16	34.2	64.5	0.32	2.01	86.8	10.9	0.2	2.0	4.0	0.2	1.5	4.4	0.4	30.0	36.4	14.7	
Po 1st Cl Conc 1-2		3.0	0.11	1.15	34.7	64.0	0.31	1.95	88.2	9.5	0.3	3.0	6.2	0.3	2.2	6.8	0.5	44.7	54.3	23.0	
Cu/Ni 1st Cl Tails/Po Feed		13.8	0.05	0.69	32.0	67.2	0.15	0.77	82.4	16.7	0.7	8.5	26.6	0.7	4.1	29.8	4.1				
Cu/Ni Ro Conc 1-3&Po Ro Conc 1-2		34.3	2.94	2.94	34.8	59.3	8.53	7.10	76.6	7.8	98.3	89.0	71.8	98.3	94.5	68.6	4.7				

Test: F14 **Project:** 18559-01 **Date:** July 13, 2021 **Operator:** Deepak

Purpose: Conduct rougher kinetics test on S Comp, target ~150 um

Procedure: As outlined below.

Feed: 2kg S Comp -10 mesh Freezer\SEC-12C Box 115029

Grind: 24 minutes at 65% solids in 2 kg Rod Mill #3 Comb Prod P₈₀ = 142 µm

Regrind: N/A

Conditions:

Stage	Reagents added, grams per tonne						Time, minutes			pH	ORP, mV
	Lime		PAX	MIBC*			Grind	Cond.	Froth		
Grind	350		5				24			9.0	388
Cu/Ni Rougher No. 1	0			0				1	1	9.0	388
Cu/Ni Rougher No. 2	0		5	0				1	2	9.0	256
Cu/Ni Rougher No. 3	0		5	5				1	2	9.0	253
Po Rougher No. 1	0		10	5				1	3	natural pH	274
Po Rougher No. 2	0		10	10				1	5	natural pH	241
Po Rougher No. 3	0		10	15				1	5	natural pH	322
Total	0	0	40	35	0				18		

* Add as required.

Stage	Rougher/Scavenger	Po Rougher	Cu/Ni 1st/2nd Cleaner	Po 1st & 2nd Cl
Flotation Cell	2 kg float cell	2 kg float cell	500g/250g float cell	250g float cell
Speed: r.p.m.	1800	1800	1500/1200	1200

Metallurgical Balance

Product	Weight		Assays, %								% Distribution						
	g	%	Cu	Ni	S	Other	Cp	Pn	Po	Ga	Cu	Ni	S	Cp	Pn	Po	Ga
Cu/Ni Ro Conc 1	154.4	7.7	16.7	5.15	32.7	45.5	48.4	13.9	29.0	8.68	67.7	44.3	21.0	67.7	50.9	9.2	1.0
Cu/Ni Ro Conc 2	196.4	9.8	4.86	2.81	34.0	58.3	14.1	6.83	69.6	9.43	25.0	30.7	27.8	25.0	31.8	28.0	1.4
Cu/Ni Ro Conc 3	105.0	5.2	1.84	1.47	34.2	62.5	5.33	2.94	81.5	10.3	5.1	8.6	14.9	5.1	7.3	17.5	0.8
Po Ro Conc 1	96.7	4.8	0.39	1.01	34.2	64.4	1.13	1.60	86.4	10.8	1.0	5.4	13.8	1.0	3.7	17.1	0.8
Po Ro Conc 2	60.9	3.0	0.31	0.96	32.4	66.3	0.90	1.52	82.0	15.5	0.5	3.3	8.2	0.5	2.2	10.2	0.7
Po Ro Conc 3	33.8	1.7	0.28	0.86	29.6	69.3	0.81	1.33	75.0	22.9	0.2	1.6	4.2	0.2	1.1	5.2	0.6
Po Ro Tails	1361.0	67.8	0.01	0.08	1.80	98.1	0.04	0.09	4.56	95.3	0.5	6.1	10.2	0.5	3.0	12.7	94.9
Head (Calc.)	2008.2	100	1.90	0.89	12.0	85.2	5.50	2.10	24.3	68.1	100	100	100	100	100	100	100
Head (Dir.)			1.90	0.88	11.9	85.3	5.51	2.06	24.1	68.3							

Combined Products

Cu/Ni Ro Conc 1		7.7	16.7	5.15	32.7	45.5	48.4	13.9	29.0	8.68	67.7	44.3	21.0	67.7	50.9	9.2	1.0
Cu/Ni Ro Conc 1-2		17.5	10.1	3.84	33.4	52.7	29.2	9.94	51.8	9.10	92.7	75.0	48.8	92.7	82.7	37.2	2.3
Cu/Ni Ro Conc 1-3		22.7	8.18	3.29	33.6	54.9	23.7	8.33	58.6	9.37	97.8	83.6	63.7	97.8	90.1	54.7	3.1
Po Ro Conc 1		4.8	0.39	1.01	34.2	64.4	1.13	1.60	86.4	10.8	1.0	5.4	13.8	1.0	3.7	17.1	0.8
Po Ro Conc 1-2		7.8	0.36	0.99	33.5	65.1	1.04	1.57	84.7	12.7	1.5	8.7	22.0	1.5	5.9	27.4	1.5
Po Ro Conc 1-3		9.5	0.35	0.97	32.8	65.9	1.00	1.52	83.0	14.5	1.7	10.3	26.1	1.7	6.9	32.6	2.0
Cu/Ni & Po Ro Conc 1-3		32.2	5.86	2.61	33.4	58.2	17.0	6.32	65.8	10.9	99.5	93.9	89.8	99.5	97.0	87.3	5.1
Po Ro Feed		77.3	0.05	0.19	5.62	94.1	0.16	0.27	14.2	85.3	2.2	16.4	36.3	2.2	9.9	45.3	96.9

Test: F15 **Project:** 18559-01 **Date:** July 13, 2021 **Operator:** Deepak

Purpose: Conduct rougher kinetics test on P Comp, target ~150 um

Procedure: As outlined below.

Feed: 2kg P Comp -10 mesh Freezer\SEC-11C Box 115025

Grind: 20 minutes at 65% solids in 2 kg Rod Mill #3 **Comb Prod** **P₈₀ = 147 μm**

Regrind N/A

Conditions:

Stage	Reagents added, grams per tonne						Time, minutes			pH	ORP, mV
	Lime		PAX	MIBC*			Grind	Cond.	Froth		
Grind	550		5				20			9.0	441
Cu/Ni Rougher No. 1	0			5				1	1	9.0	416
Cu/Ni Rougher No. 2	5		5	0				1	2	9.0	276
Cu/Ni Rougher No. 3	20		5	0				1	2	9.0	229
Po Rougher No. 1	0		20	5				1	3	natural pH	248
Po Rougher No. 2	0		20	5				1	5	natural pH	256
Po Rougher No. 3	0		20	15				1	5	natural pH	262
Total	25	0	70	30	0				18		

* Add as required.

Stage	Rougher/Scavenger	Po Rougher	Cu/Ni 1st/2nd Cleaner	Po 1st & 2nd Cl
Flotation Cell	2 kg float cell	2 kg float cell	500g/250g float cell	250g float cell
Speed: r.p.m.	1800	1800	1500/1200	1200

Metallurgical Balance

Product	Weight		Assays, %								% Distribution						
	g	%	Cu	Ni	S	Other	Cp	Pn	Po	Ga	Cu	Ni	S	Cp	Pn	Po	Ga
Cu/Ni Ro Conc 1	44.9	2.2	12.7	7.95	27.6	51.8	36.8	21.8	19.5	21.9	68.8	22.5	5.8	68.8	27.3	1.7	0.7
Cu/Ni Ro Conc 2	110.9	5.5	1.70	4.72	33.0	60.6	4.93	12.1	70.8	12.1	22.8	33.1	17.0	22.8	37.4	15.5	0.9
Cu/Ni Ro Conc 3	96.1	4.8	0.29	1.83	33.6	64.3	0.84	3.92	83.1	12.1	3.4	11.1	15.0	3.4	10.5	15.8	0.8
Po Ro Conc 1	128.6	6.4	0.09	1.14	34.2	64.6	0.27	1.95	86.9	10.9	1.4	9.3	20.4	1.4	7.0	22.1	1.0
Po Ro Conc 2	96.6	4.8	0.07	1.03	30.9	68.0	0.21	1.76	78.6	19.5	0.9	6.3	13.9	0.9	4.7	15.0	1.3
Po Ro Conc 3	45.7	2.3	0.08	0.93	30.5	68.5	0.22	1.49	77.7	20.5	0.4	2.7	6.5	0.4	1.9	7.0	0.6
Po Ro Tails	1491.3	74.0	0.01	0.16	3.09	96.7	0.04	0.27	7.76	91.9	2.3	15.1	21.4	2.3	11.2	22.9	94.7
Head (Calc.)	2014.1	100	0.41	0.79	10.7	88.1	1.19	1.78	25.1	71.9	100	100	100	100	100	100	100
Head (Dir.)			0.42	0.79	10.4	88.4	1.22	1.80	24.4	72.6							

Combined Products

Cu/Ni Ro Conc 1		2.2	12.7	7.95	27.6	51.8	36.8	21.8	19.5	21.9	68.8	22.5	5.8	68.8	27.3	1.7	0.7
Cu/Ni Ro Conc 1-2		7.7	4.87	5.65	31.4	58.0	14.1	14.9	56.1	14.9	91.6	55.6	22.8	91.6	64.7	17.3	1.6
Cu/Ni Ro Conc 1-3		12.5	3.12	4.19	32.3	60.4	9.05	10.7	66.4	13.8	94.9	66.7	37.8	94.9	75.2	33.0	2.4
Po Ro Conc 1		6.4	0.09	1.14	34.2	64.6	0.27	1.95	86.9	10.9	1.4	9.3	20.4	1.4	7.0	22.1	1.0
Po Ro Conc 1-2		11.2	0.08	1.09	32.8	66.0	0.25	1.87	83.3	14.6	2.3	15.5	34.3	2.3	11.7	37.1	2.3
Po Ro Conc 1-3		13.5	0.08	1.07	32.4	66.5	0.24	1.80	82.4	15.6	2.7	18.2	40.8	2.7	13.6	44.1	2.9
Cu/Ni & Po Ro Conc 1-3		26.0	1.55	2.57	32.3	63.5	4.49	6.10	74.7	14.7	97.7	84.9	78.6	97.7	88.8	77.1	5.3
Po Ro Feed		87.5	0.02	0.30	7.60	92.1	0.07	0.51	19.2	80.2	5.1	33.3	62.2	5.1	24.8	67.0	97.6

Test: F16 Project: 18559-01 Date: July 16, 2021 Operator: Deepak

Purpose: Similar to F9, with no Na2SO3 and 25 DETA. Full Cleaner test with CuSEP

Procedure: As outlined below.

Feed: 2kg SN Comp -10 mesh Freezer\SEC-11C

Grind: 34 minutes at 65% solids in 2 kg Rod Mill # 3
 Regrind: 12 minutes at 50% solids in 2 kg Rod Mill for Cu/Ni R.Conc
 48 minutes at 50% solids in 2 kg Rod Mill for Po R.Conc
 P₈₀ =
 P₈₀ =
 P₈₀ = 35 µm
 Po Ro Tails

Conditions:

Stage	Reagents added, grams per tonne						Time, minutes					pH	ORP, mV
	Lime	CuSO4	Na2SO3	DETA	PAX	MIBC*	Grind	Cond.	Froth				
Grind	625				5		34				9.0	42	
Cu/Ni Rougher No. 1	0							1	2		9.0	42	
Cu/Ni Rougher No. 2	5				5			1	2		9.0	149	
Cu/Ni Rougher No. 3	25				5			1	2		9.0	148	
Regrind (2kg Rod Mill)	225		0	25	2		12				9.4	125	
Cu/Ni 1st Cleaner No.1	5							1	2		9.5	102	
Cu/Ni 1st Cleaner No.2	10				1			1	3		9.5	126	
Cu/Ni Cleaner Scav	30				2			1	3		9.5	116	
Cu/Ni 2nd Cleaner	15				0	0		1	4		9.5	124	
Po Rougher No. 1	-				5			1	3	natural pH		168	
Po Rougher No. 2	-				5			1	5	natural pH		132	
Po Rougher No. 3	-				5			1	5	natural pH		171	
<i>Po Cleaning on (Po Ro Con 1-3 + Cu/Ni Cleaner Scav Tails)</i>													
Regrind (2kg Rod Mill)	300		0	50	0		48				9.1	0	
Po 1st Cleaner	0				2			1	2		9.0	-3	
Po 1st Cleaner Scav	30				2			1	2		9.0	104	
Po 2nd Cleaner	20							1	2		9.0	77	
Po 2nd Cleaner Scav	-			5	1			1	0.5				
Po 3rd Cleaner	5			5	1			1	1		9.3	113	
CuSEP													
COND	130							10			11.5	-5	
Cu Ro 1	35				0			1	2		11.5	-50	
Cu Ro 2	-				0			1	2				
Cu Ro Scav	-				1			1	2				
Cu 1st Cl	105				0			1	4		11.5	-35	
Cu 2nd Cl	80				0			1	3		11.5	-3	
Cu 3rd Cl	90				0			1	2.5		11.5	-19	
Total	940	0	0	85	37	0				48.5			

Target 20 wt% ... ~ 96.5% Cu, 75% Ni

Target pH 9.5

Target pH 9.5

Target pH 9.0

target pH 11

* Add as required.

Stage	Rougher/Scavenger	Po Rougher	Cu/Ni 1st/2nd Cleaner	Po 1st & 2nd Cl
Flotation Cell	2 kg float cell	2 kg float cell	500g/250g float cell	250g float cell
Speed: r.p.m.	1800	1800	1500/1200	1200

Metallurgical Balance

Product	Weight		Assays, %								% Distribution						
	g	%	Cu	Ni	S	Other	Cp	Pn	Po	Ga	Cu	Ni	S	Cp	Pn	Po	Ga
Cu 3rd Cleaner Conc	49.0	2.4	28.8	2.13	35.1	34.0	83.5	5.8	10.3	0.42	68.8	4.4	5.3	68.8	5.2	0.7	0.0
Cu 3rd Cleaner Tails	9.8	0.5	13.4	13.9	33.1	39.6	38.8	38.4	17.8	5.01	6.4	5.8	1.0	6.4	6.9	0.2	0.0
Cu 2nd Cleaner Tails	14.3	0.7	9.49	17.8	33.2	39.5	27.5	49.2	19.1	4.24	6.6	10.8	1.5	6.6	13.0	0.4	0.1
Cu 1st Cleaner Tails	16.8	0.8	3.65	21.2	33.4	41.8	10.6	58.5	27.0	3.93	3.0	15.1	1.7	3.0	18.2	0.6	0.1
Cu Ro Scav Conc	13.3	0.7	6.37	16.9	34.9	41.8	18.5	46.5	34.0	1.0	4.1	9.6	1.4	4.1	11.4	0.6	0.0
Cu Ro Scav Tails	10.5	0.5	1.01	12.4	32.9	53.7	2.93	33.7	53.9	9.5	0.5	5.5	1.1	0.5	6.5	0.8	0.1
Cu/Ni 2nd Cleaner Tails	47.3	2.3	0.84	3.73	35.1	60.3	2.43	9.23	81.0	7.3	1.9	7.5	5.1	1.9	8.1	5.1	0.3
Cu/Ni Cleaner Scav Conc	37.2	1.8	0.94	4.33	36.0	58.7	2.72	10.9	81.7	4.7	1.7	6.8	4.1	1.7	7.5	4.1	0.1
Po 3rd Cleaner Conc	8.9	0.4	1.49	4.48	37.3	56.7	4.32	11.3	83.3	1.11	0.6	1.7	1.0	0.6	1.9	1.0	0.0
Po 3rd Cleaner Tails	10.2	0.5	0.60	2.09	36.8	60.5	1.74	4.55	90.1	3.61	0.3	0.9	1.2	0.3	0.9	1.2	0.0
Po 2nd Cleaner Scav Conc	6.2	0.3	0.46	2.27	36.8	60.5	1.33	5.05	90.0	3.57	0.1	0.6	0.7	0.1	0.6	0.7	0.0
Po 2nd Cleaner Scav Tails	40.9	2.0	0.23	1.28	34.1	64.4	0.67	2.35	85.9	11.0	0.5	2.2	4.3	0.5	1.8	4.7	0.4
Po 1st Cleaner Scav Conc	23.2	1.1	0.56	2.42	33.5	63.5	1.62	5.59	80.7	12.0	0.6	2.4	2.4	0.6	2.4	2.5	0.2
Po 1st Cleaner Scav Tails	519.0	25.6	0.14	0.85	31.1	67.9	0.41	1.25	79.3	19.0	3.5	18.8	49.6	3.5	11.9	55.3	8.4
Po Ro Tails	1223.9	60.3	0.02	0.15	5.23	94.6	0.06	0.17	13.4	86.4	1.2	7.8	19.7	1.2	3.8	22.0	90.2
Head (Calc.)	2030.5	100	1.01	1.16	16.0	81.8	2.93	2.67	36.7	57.7	100	100	100	100	100	100	100
Head (Dir.)			1.07	1.17	16.5	81.3	3.10	2.69	37.7	56.5							

Combined Products																		Stage Recovery		
	Cp	Pn	Po																	
Cu 3rd Cleaner Conc		2.4	28.8	2.13	35.1	34.0	83.5	5.8	10.3	0.42	68.8	4.4	5.3	68.8	5.2	0.7	0.0	91.5	42.9	74.4
Cu 2nd Cleaner Conc		2.9	26.2	4.09	34.8	34.9	76.0	11.2	11.6	1.18	75.2	10.2	6.3	75.2	12.2	0.9	0.1	91.9	48.4	71.4
Cu 1st Cleaner Conc		3.6	23.0	6.77	34.5	35.8	66.5	18.6	13.0	1.78	81.8	21.0	7.7	81.8	25.2	1.3	0.1	96.5	58.1	67.8
Cu Ro Conc		4.4	19.3	9.47	34.3	36.9	56.1	26.1	15.6	2.18	84.8	36.2	9.5	84.8	43.3	1.9	0.2	94.8	70.7	58.0
Cu Ro & Scav Conc		5.1	17.7	10.4	34.3	37.6	51.2	28.7	18.0	2.03	88.9	45.7	10.9	88.9	54.7	2.5	0.2	99.4	89.3	76.7
Cu/Ni 2nd CI Conc		5.6	16.1	10.6	34.2	39.0	46.8	29.2	21.3	2.72	89.4	51.3	12.0	89.4	61.3	3.3	0.3	97.9	88.4	38.8
Cu/Ni 1st CI Conc		7.9	11.6	8.59	34.5	45.3	33.7	23.3	38.9	4.06	91.4	58.8	17.1	91.4	69.3	8.4	0.6			
Cu/Ni 1st CI & Scav Conc		9.8	9.63	7.79	34.8	47.8	27.9	21.0	46.9	4.18	93.1	65.6	21.2	93.1	76.8	12.5	0.7			
Po 3rd Cleaner Conc		0.4	1.49	4.48	37.3	56.7	4.32	11.3	83.3	1.11	0.6	1.7	1.0	0.6	1.9	1.0	0.0	68.4	68.4	44.6
Po 2nd Cleaner Conc		0.9	1.01	3.20	37.0	58.7	2.94	7.69	86.9	2.44	0.9	2.6	2.2	0.9	2.7	2.2	0.0	61.3	53.5	29.0
Po 2nd Cleaner & Scav Conc		1.2	0.88	2.97	37.0	59.2	2.55	7.04	87.7	2.72	1.1	3.2	2.9	1.1	3.3	3.0	0.1	70.3	64.9	38.7
Po 1st Cleaner Conc		3.3	0.48	1.93	35.2	62.4	1.39	4.15	86.6	7.86	1.5	5.4	7.2	1.5	5.1	7.7	0.4	27.0	26.1	11.8
Po 1st Cleaner & Scav Conc		4.4	0.50	2.06	34.8	62.7	1.45	4.52	85.1	8.94	2.2	7.8	9.5	2.2	7.5	10.2	0.7	38.1	38.5	15.6
Po Ro Conc 1-3 & Cu/Ni CI Scav Tails		30.0	0.19	1.03	31.6	67.1	0.56	1.73	80.2	17.5	5.7	26.6	59.2	5.7	19.4	65.5	9.1			
Cu/Ni Ro Conc 1-3&Po Ro Conc 1-3		39.7	2.51	2.69	32.4	62.4	7.28	6.46	72.0	14.2	98.8	92.2	80.3	98.8	96.2	78.0	9.8			

Test: F17 Project: 18559-01 Date: July 20, 2021 Operator: Deepak

Purpose: Similar to F9, 1st Cleaner Kinetics on S Comp

Procedure: As outlined below.

Feed: 2kg S Comp -10 mesh Freezer\SEC-12C Box 115029

Grind: 22 minutes at 65% solids in 2 kg Rod Mill # 3 P₈₀ = 158 µm
 Regrind: 12 minutes at 50% solids in 2 kg Rod Mill for Cu/Ni R.Conc Cu /Ni 1st CI Tails P₈₀ = 51 µm
 10 minutes at 50% solids in Attrition Mill for Po R.Conc Po 1st CI Tails P₈₀ = 50 µm

Conditions:

Stage	Reagents added, grams per tonne						Time, minutes			pH	ORP, mV	
	Lime	CuSO4	Na2SO3	DETA	PAX	MIBC*	Grind	Cond.	Froth			
Grind	350				5		22			9.0	134	
Cu/Ni Rougher No. 1	0					0		1	1	9.0	134	
Cu/Ni Rougher No. 2	5				5	5		1	2	9.0	256	
Cu/Ni Rougher No. 3	5				7.5	2.5		1	2+0.5	9.0	253	
Regrind (2kg Rod Mill)	225			25	1		12			9.5	128	
Cu/Ni 1st Cleaner No.1	0					0		1	2	9.5	128	
Cu/Ni 1st Cleaner No.2	15				1	0		1	2	9.5	151	
Cu/Ni 1st Cleaner No.3	25				2	0		1	3	9.5	154	
Cu/Ni 1st Cleaner No.4	10				2	0		1	3	9.5	162	
Po Rougher No. 1					10	5		1	3	natural pH	188	
Po Rougher No. 2					10	10		1	5	natural pH	210	
Po Rougher No. 3					10	10		1	5	natural pH	226	
<i>Po Cleaning on Po Ro Con 1-3</i>		Attrition Mill with Ceramic Balls										
Regrind (Attrition Mill)	175			25	1		10			9.6	143	
										9.6		
Po 1st Cleaner No.1	0			0		0		1	2	9.0	143	
Po 1st Cleaner No.2	0			5	1+1	0		1	2	9.0	180	
Po 1st Cleaner No.3	10			0	1+1	0		1	2	9.0	182	
Total	470	0	0	55	49.5	32.5			32			

Target pH 9.5

Target pH 9.0

* Add as required.

Stage	Rougher/Scavenger	Po Rougher	Cu/Ni 1st/2nd Cleaner	Po 1st & 2nd CI
Flotation Cell	2 kg float cell	2 kg float cell	500g/250g float cell	250g float cell
Speed: r.p.m.	1800	1800	1500/1200	1200

Metallurgical Balance

Product	Weight		Assays, %								% Distribution								Stage Recovery		
	g	%	Cu	Ni	S	Other	Cp	Pn	Po	Ga	Cu	Ni	S	Cp	Pn	Po	Ga	Cp			
Cu/Ni 1st Cl Conc 1	139.1	6.9	22.6	4.75	35.1	37.6	65.5	12.9	20.6	1.03	79.7	36.2	20.6	79.7	41.7	6.0	0.1				
Cu/Ni 1st Cl Conc 2	45.6	2.3	12.2	8.34	34.3	45.2	35.4	22.6	37.5	4.46	14.1	20.8	6.6	14.1	24.0	3.6	0.1				
Cu/Ni 1st Cl Conc 3	54.2	2.7	2.02	4.51	36.5	57.0	5.86	11.4	79.7	3.03	2.8	13.4	8.4	2.8	14.4	9.1	0.1				
Cu/Ni 1st Cl Conc 4	68.6	3.4	0.36	1.58	37.9	60.2	1.04	3.07	94.9	1.02	0.6	5.9	11.0	0.6	4.9	13.7	0.1				
Cu/Ni 1st Cl Tails	164.0	8.2	0.17	0.87	29.4	69.6	0.49	1.36	74.7	23.4	0.7	7.8	20.4	0.7	5.2	25.9	2.8				
Po 1st Cl Conc 1	40.7	2.0	0.33	1.29	37.3	61.1	0.96	2.27	94.1	2.70	0.3	2.9	6.4	0.3	2.1	8.1	0.1				
Po 1st Cl Conc 2	23.1	1.1	0.36	1.17	36.7	61.8	1.04	1.96	92.7	4.30	0.2	1.5	3.6	0.2	1.1	4.5	0.1				
Po 1st Cl Conc 3	20.2	1.0	0.37	1.23	36.0	62.4	1.07	2.15	90.7	6.09	0.2	1.4	3.1	0.2	1.0	3.9	0.1				
Po 1st Cl Tails	95.1	4.7	0.20	0.76	28.6	70.4	0.58	1.08	72.8	25.5	0.5	4.0	11.5	0.5	2.4	14.6	1.8				
Po Ro Tails	1358.4	67.6	0.03	0.08	1.48	98.4	0.08	0.11	3.7	96.1	0.9	6.1	8.5	0.9	3.4	10.6	94.8				
Head (Calc.)	2009.0	100	1.96	0.91	11.8	85.3	5.69	2.15	23.6	68.6	100	100	100	100	100	100	100				
Head (Dir.)			1.90	0.88	11.9	85.3	5.51	2.06	24.1	68.3											
Combined Products																	Cp	Pn	Po		
Cu/Ni 1st Cl Conc 1		6.9	22.6	4.75	35.1	37.6	65.5	12.9	20.6	1.03	79.7	36.2	20.6	79.7	41.7	6.0	0.1	81.4	46.3	10.3	
Cu/Ni 1st Cl Conc 1-2		9.2	20.0	5.64	34.9	39.4	58.1	15.3	24.7	1.88	93.8	57.1	27.2	93.8	65.6	9.6	0.3	95.8	72.9	16.5	
Cu/Ni 1st Cl Conc 1-3		11.9	15.9	5.38	35.3	43.4	46.2	14.4	37.2	2.14	96.5	70.5	35.6	96.5	80.0	18.8	0.4	98.6	88.8	32.1	
Cu/Ni 1st Cl Conc 1-4		15.3	12.5	4.53	35.9	47.1	36.1	11.9	50.1	1.89	97.2	76.4	46.6	97.2	84.9	32.5	0.4	99.3	94.2	55.7	
Cu/Ni Ro Conc 1-3		23.5	8.19	3.26	33.6	54.9	23.7	8.2	58.7	9.37	97.9	84.2	66.9	97.9	90.0	58.4	3.2				
Po 1st Cl Conc 1		2.0	0.33	1.29	37.3	61.1	0.96	2.27	94.1	2.70	0.3	2.9	6.4	0.3	2.1	8.1	0.1	27.8	32.6	26.0	
Po 1st Cl Conc 1-2		3.2	0.34	1.25	37.1	61.3	0.99	2.16	93.6	3.28	0.6	4.4	10.0	0.6	3.2	12.6	0.2	45.1	48.5	40.5	
Po 1st Cl Conc 1-3		4.2	0.35	1.24	36.8	61.6	1.01	2.16	92.9	3.96	0.7	5.7	13.1	0.7	4.2	16.5	0.2	60.6	63.8	53.0	
Po Ro Conc 1-3		8.9	0.27	0.99	32.5	66.3	0.78	1.59	82.2	15.4	1.2	9.7	24.6	1.2	6.6	31.1	2.0				
Cu/Ni & Po Ro Conc 1-3		32.4	6.01	2.63	33.3	58.1	17.4	6.40	65.1	11.0	99.1	93.9	91.5	99.1	96.6	89.4	5.2				
Po Ro Feed		76.5	0.05	0.19	5.09	94.7	0.16	0.28	12.8	86.7	2.1	15.8	33.1	2.1	10.0	41.6	96.8				

Test: F18 Project: 18559-01 Date: July 20, 2021 Operator: Deepak

Purpose: Similar to F9, 1st Cleaner Kinetics on P Comp

Procedure: As outlined below.

Feed: 2kg P Comp -10 mesh Freezer\SEC-11C Box 115025

Grind: 39 minutes at 65% solids in 2 kg Rod Mill # 3 P₈₀ = 98 µm
 Regrind 12 minutes at 50% solids in 2 kg Rod Mill for Cu/Ni R.Conc Cu /Ni 1st Cl Tails P₈₀ = 41 µm
 10 minutes at 50% solids in Attrition Mill for Po R.Conc Po 1st Cl Tails P₈₀ = 42 µm

Conditions:

Stage	Reagents added, grams per tonne						Time, minutes			pH	ORP, mV	
	Lime	CuSO4	Na2SO3	DETA	PAX	MIBC*	Grind	Cond.	Froth			
Grind	550				5		39			8.8	167	
Cu/Ni Rougher No. 1	20					5		1	1	9.0	119	
Cu/Ni Rougher No. 2	5				5	0		1	2	9.0	158	
Cu/Ni Rougher No. 3	20				5	2.5		1	1	9.0	171	
Regrind (2kg Rod Mill)	150			25	1		12			9.3	179	
Cu/Ni 1st Cleaner No.1	5					0		1	2	9.5	147	
Cu/Ni 1st Cleaner No.2	5				1	0		1	2	9.5	140	
Cu/Ni 1st Cleaner No.3	15				2	0		1	3	9.5	134	
Cu/Ni 1st Cleaner No.4	15				2	0		1	3	9.5	136	
Po Rougher No. 1					10	5		1	3	natural pH	182	
Po Rougher No. 2					10	15		1	5	natural pH	203	
Po Rougher No. 3					10	10		1	5	natural pH	206	
<i>Po Cleaning on Po Ro Con 1-3</i>		Attrition Mill with Ceramic Balls										
Regrind (Attrition Mill)	175			25	1		10			10.0	117	
Po 1st Cleaner No.1	0			0		0		1	2	10.0	117	
Po 1st Cleaner No.2	0			0	1	0		1	2	9.3	154	
Po 1st Cleaner No.3	0			5	1+1+1	0		1	2	9.0	172	
Total	410	0	0	55	48	37.5			33			

Target pH 9.5

Target pH 9.0

* Add as required.

Stage	Rougher/Scavenger	Po Rougher	Cu/Ni 1st/2nd Cleaner	Po 1st & 2nd Cl
Flotation Cell	2 kg float cell	2 kg float cell	500g/250g float cell	250g float cell
Speed: r.p.m.	1800	1800	1500/1200	1200

Metallurgical Balance

Product	Weight		Assays, %								% Distribution								Stage Recovery		
	g	%	Cu	Ni	S	Other	Cp	Pn	Po	Ga	Cu	Ni	S	Cp	Pn	Po	Ga	Cp			
Cu/Ni 1st Cl Conc 1	43.8	2.2	13.4	10.1	35.9	40.6	38.8	27.6	34.3	-0.72	70.1	27.6	7.5	70.1	32.9	3.1	0.0				
Cu/Ni 1st Cl Conc 2	15.8	0.8	5.85	14.7	33.0	46.5	17.0	40.3	35.7	6.98	11.0	14.5	2.5	11.0	17.4	1.2	0.1				
Cu/Ni 1st Cl Conc 3	19.1	0.9	1.64	8.81	38.7	50.9	4.75	23.4	76.1	-4.30	3.7	10.5	3.5	3.7	12.2	3.0	-0.1				
Cu/Ni 1st Cl Conc 4	14.7	0.7	0.84	4.35	39.3	55.5	2.43	10.8	90.6	-3.85	1.5	4.0	2.8	1.5	4.3	2.7	0.0				
Cu/Ni 1st Cl Tails	148.2	7.4	0.30	1.31	31.3	67.1	0.87	2.54	78.3	18.3	5.3	12.1	22.2	5.3	10.3	23.7	1.8				
Po 1st Cl Conc 1	30.3	1.5	0.54	2.47	36.3	60.7	1.57	5.63	88.0	4.77	2.0	4.7	5.3	2.0	4.7	5.4	0.1				
Po 1st Cl Conc 2	20.3	1.0	0.39	1.84	35.0	62.8	1.13	3.90	86.5	8.43	0.9	2.3	3.4	0.9	2.2	3.6	0.1				
Po 1st Cl Conc 3	23.8	1.2	0.20	1.31	35.2	63.3	0.58	2.40	88.8	8.18	0.6	1.9	4.0	0.6	1.6	4.3	0.1				
Po 1st Cl Tails	180.4	8.9	0.05	0.73	30.3	68.9	0.15	0.93	77.8	21.2	1.1	8.2	26.1	1.1	4.6	28.6	2.6				
Po Ro Tails	1519.5	75.4	0.02	0.15	3.14	96.7	0.06	0.24	7.9	91.8	3.8	14.2	22.8	3.8	10.0	24.5	95.2				
Head (Calc.)	2015.9	100	0.42	0.80	10.4	88.4	1.20	1.82	24.3	72.7	100	100	100	100	100	100	100				
Head (Dir.)			0.42	0.79	10.4	88.4	1.22	1.80	24.4	72.6											
Combined Products																	Cp	Pn	Po		
Cu/Ni 1st Cl Conc 1		2.2	13.4	10.1	35.9	40.6	38.8	27.6	34.3	-0.72	70.1	27.6	7.5	70.1	32.9	3.1	0.0	76.5	42.7	9.1	
Cu/Ni 1st Cl Conc 1-2		3.0	11.4	11.3	35.1	42.2	33.0	31.0	34.7	1.32	81.1	42.1	10.0	81.1	50.3	4.2	0.1	88.5	65.3	12.6	
Cu/Ni 1st Cl Conc 1-3		3.9	9.03	10.7	36.0	44.3	26.2	29.1	44.7	-0.04	84.8	52.6	13.5	84.8	62.5	7.2	0.0	92.6	81.1	21.4	
Cu/Ni 1st Cl Conc 1-4		4.6	7.74	9.71	36.5	46.0	22.4	26.2	52.0	-0.64	86.3	56.5	16.3	86.3	66.8	9.9	0.0	94.2	86.7	29.5	
Cu/Ni Ro Conc 1-3		12.0	3.18	4.56	33.3	58.9	9.2	11.7	68.1	11.0	91.6	68.6	38.4	91.6	77.1	33.6	1.8				
Po 1st Cl Conc 1		1.5	0.54	2.47	36.3	60.7	1.57	5.63	88.0	4.77	2.0	4.7	5.3	2.0	4.7	5.4	0.1	42.8	35.9	13.0	
Po 1st Cl Conc 1-2		2.5	0.48	2.22	35.8	61.5	1.39	4.94	87.4	6.24	2.9	7.0	8.6	2.9	6.8	9.0	0.2	63.5	52.6	21.5	
Po 1st Cl Conc 1-3		3.7	0.39	1.93	35.6	62.1	1.13	4.13	87.9	6.86	3.5	8.9	12.6	3.5	8.4	13.3	0.3	75.9	64.6	31.8	
Po Ro Conc 1-3	254.8	12.6	0.15	1.08	31.8	66.9	0.44	1.87	80.7	17.0	4.6	17.1	38.8	4.6	13.0	42.0	3.0				
Cu/Ni Ro Conc 1-3&Po Ro Conc 1-3		24.6	1.62	2.77	32.6	63.0	4.70	6.65	74.6	14.0	96.2	85.8	77.2	96.2	90.0	75.5	4.8				
Po Ro Feed		88.0	0.04	0.28	7.3	92.4	0.11	0.47	18.4	81.1	8.4	31.4	61.6	8.4	22.9	66.4	98.2				

Test: F19 **Project:** 18559-01 **Date:** July 22, 2021 **Operator:** Deepak

Purpose: Similar to F16, with polish grind on CuSEP, clean Po Ro Conc and Cu/Ni Cl tails separately
Procedure: As outlined below.

Feed: 2kg SN Comp -10 mesh Freezer/SEC-11C

Grind: 34 minutes at 65% solids in 2 kg Rod Mill # 3 P₈₀ =
Regrind: 12 minutes at 50% solids in 2 kg Rod Mill for Cu/Ni R.Conc P₈₀ =
 17 minutes at 50% solids in Attrition Mill for Po R.Conc - Ceramic balls Po 1st Cl Tails P₈₀ = 30.4 µm
 6 minutes at 50% solids in Attrition Mill for Cu/Ni Cl Scav Tails - Ceran Cu/Ni Tails 1st Cl tails P₈₀ = 33.4 µm

Conditions:

Stage	Reagents added, grams per tonne						Time, minutes				pH	ORP, mV
	Lime	Na2SO3	DETA	PAX	MIBC*	Grind	Cond.	Froth				
Grind	625			5		34				8.9	151	
Cu/Ni Rougher No. 1	25						1	2		9.0	158	
Cu/Ni Rougher No. 2	25			5	2.5		1	2		9.0	159	
Cu/Ni Rougher No. 3	15			5			1	2		9.0	174	
Regrind (2kg Rod Mill)	225	0	25	2		12				9.3	172	
Cu/Ni 1st Cleaner No.1	5						1	2		9.5	144	
Cu/Ni 1st Cleaner No.2	40			3			1	3		9.5	143	
Cu/Ni Cleaner Scav	30			2			1	3		9.5	148	
Po Rougher No. 1	-			5			1	3	natural pH		195	
Po Rougher No. 2	-			5	5		1	5	natural pH		210	
Po Rougher No. 3	-			5	5		1	5	natural pH		223	
Po Cleaning on (Po Ro Con 1-3)												
Regrind on Po Ro Con 1-3 only												
Regrind (Attrition Mill, Ceramic balls)	300	0		0		17				10.3	90	
Po 1st Cleaner-1	0		75	4			1	1		10.3	90	
Po 1st Cleaner-2	0			2			1	1		9.5	132	
Po 1st Cleaner-3	0			2			1	1				
Po 2nd Cleaner	10		5	1			1	2		9.0	161	
Cleaning on Cu/Ni Cleaner Scav Tails												
Regrind on Cu/Ni Cleaner Scav Tails												
Regrind (Attrition Mill, Ceramic balls)	300	0		0		6				9.9	128	
Cu/Ni Tails 1st Cleaner-1	0		100	6			1	2		9.9	128	
Cu/Ni Tails 1st Cleaner-2	0		50	7			1	2		9.0	104	
CuSEP												
Polish Grind (Pepple mill)	500					5				11.5	26	
Cu Ro 1	0			0			1	2		11.5	26	
Cu Ro 2	20			0			1	2		11.5	26	
Cu Ro Scav	30			1			1	2		11.5	26	
Cu 1st Cl	95			0			1	3		11.5	23	
Cu 2nd Cl	85			0			1	3		11.5	28	
Cu 3rd Cl	105			0			1	2.5		11.5	38	
Total	1620	0	0	255	55	12.5			45			

Target 20 wt% ... ~ 96.5% Cu, 75% Ni

Target pH 9.5

Target pH 9.0

* Add as required.

Stage	Rougher/Scavenger	Po Rougher	Cu/Ni 1st/2nd Cleaner	Po 1st & 2nd Cl
Flotation Cell	2 kg float cell	2 kg float cell	500g/250g float cell	250g float cell
Speed: r.p.m.	1800	1800	1500/1200	1200

Metallurgical Balance

Product	Weight		Assays, %								% Distribution									
	g	%	Cu	Ni	S	Other	Cp	Pn	Po	Ga	Cu	Ni	S	Cp	Pn	Po	Ga			
Cu 3rd Cleaner Conc	32.7	1.6	33.8	0.42	35.1	30.7	98.0	1.15	1.12	-0.24	54.2	0.6	3.4	54.2	0.7	0.0	0.0			
Cu 3rd Cleaner Tails	5.6	0.3	27.3	2.19	32.7	37.8	79.1	5.97	7.88	7.02	7.5	0.5	0.5	7.5	0.6	0.1	0.0			
Cu 2nd Cleaner Tails	5.3	0.3	15.8	6.15	30.2	47.9	45.8	16.8	22.4	15.0	4.1	1.4	0.5	4.1	1.6	0.2	0.1			
Cu 1st Cleaner Tails	9.7	0.5	10.7	12.5	32.6	44.2	31.0	34.3	27.0	7.60	5.1	5.0	0.9	5.1	6.0	0.3	0.1			
Cu Ro Scav Conc	17.8	0.9	13.9	11.7	34.3	40.1	40.3	32.2	24.9	2.65	12.1	8.7	1.8	12.1	10.4	0.6	0.0			
Cu Ro Scav Tails	93.9	4.6	2.12	11.5	34.7	51.7	6.14	31.1	57.9	4.86	9.8	44.9	9.7	9.8	53.0	7.0	0.4			
Cu/Ni Tails 1st Cleaner Conc	64.7	3.2	0.13	0.77	32.9	66.2	0.38	0.96	84.3	14.4	0.4	2.1	6.3	0.4	1.1	7.0	0.8			
Cu/Ni 1st Cleaner Scav Conc	29.4	1.5	0.63	3.15	36.5	59.7	1.83	7.54	86.7	3.95	0.9	3.9	3.2	0.9	4.0	3.3	0.1			
Cu/Ni Tails 1st Cleaner Tails	208.1	10.3	0.18	1.36	36.3	62.2	0.52	2.50	91.7	5.31	1.8	11.8	22.4	1.8	9.4	24.6	1.0			
Po 2nd Cleaner Conc	12.3	0.6	0.60	1.80	37.0	60.6	1.74	3.73	91.3	3.21	0.4	0.9	1.3	0.4	0.8	1.4	0.0			
Po 2nd Cleaner Tails	41.9	2.1	0.41	1.55	35.0	63.0	1.19	3.09	87.2	8.54	0.8	2.7	4.3	0.8	2.3	4.7	0.3			
Po 1st Cleaner Tails	226.7	11.2	0.12	0.85	33.2	65.8	0.35	1.17	84.9	13.6	1.3	8.0	22.3	1.3	4.8	24.8	2.7			
Po Ro Tails	1275.7	63.0	0.02	0.18	6.2	93.6	0.07	0.22	15.8	83.9	1.5	9.6	23.4	1.5	5.1	26.0	94.4			
Head (Calc.)	2023.8	100	1.01	1.19	16.7	81.1	2.92	2.72	38.3	56.0	100	100	100	100	100	100	100			
Head (Dir.)			1.07	1.17	16.5	81.3	3.10	2.69	37.7	56.5										
Combined Products																	Stage Recovery			
																		Cp	Pn	Po
Cu 3rd Cleaner Conc	32.7	1.6	33.8	0.42	35.1	30.7	98.0	1.15	1.12	-0.24	54.2	0.6	3.4	54.2	0.7	0.0	0.0	87.8	53.0	45.3
Cu 2nd Cleaner Conc	38.3	1.9	32.8	0.68	34.7	31.7	95.2	1.86	2.11	0.82	61.7	1.1	3.9	61.7	1.3	0.1	0.0	93.8	44.4	40.4
Cu 1st Cleaner Conc	43.6	2.2	30.8	1.34	34.2	33.7	89.2	3.67	4.58	2.55	65.8	2.4	4.4	65.8	2.9	0.3	0.1	92.8	32.4	43.2
Cu Ro Conc	53.3	2.6	27.1	3.37	33.9	35.6	78.6	9.25	8.67	3.46	70.9	7.5	5.4	70.9	8.9	0.6	0.2	76.4	12.4	7.3
Cu Ro & Scav Conc	71.1	3.5	23.8	5.46	34.0	36.7	69.0	15.0	12.7	3.26	83.0	16.2	7.2	83.0	19.3	1.2	0.2	89.5	26.7	14.3
Cu/Ni 1st Cl Conc	165.0	8.2	11.5	8.90	34.4	45.2	33.2	24.2	38.4	4.17	92.8	61.1	16.8	92.8	72.3	8.2	0.6	96.7	83.2	19.0
Cu/Ni 1st Cl & Scav Conc	194.4	11.3	8.32	6.79	29.4	55.5	24.1	18.3	38.7	3.50	93.7	64.9	20.0	93.7	76.4	11.5	0.7			
Cu/Ni Tails 1st Cl Conc	64.7	3.2	0.13	0.77	32.9	66.2	0.38	0.96	84.3	14.4	0.4	2.1	6.3	0.4	1.1	7.0	0.8			
Cu/Ni 1st Cl Scav Tails	272.8	14.9	0.15	1.10	32.0	66.7	0.44	1.93	81.2	6.73	2.2	13.9	28.7	2.2	10.6	31.6	1.8			
Cu/Ni Ro Conc 1-3	467.2	23.1	4.19	4.05	35.2	56.6	12.1	10.3	71.5	6.08	96.0	78.8	48.7	96.0	86.9	43.1	2.5			
Po 2nd Cleaner Conc	12.3	0.6	0.60	1.80	37.0	60.6	1.74	3.73	91.3	3.21	0.4	0.9	1.3	0.4	0.8	1.4	0.0	30.1	26.2	23.5
Po 1st Cleaner Conc	54.2	2.7	0.45	1.61	35.5	62.5	1.31	3.23	88.1	7.33	1.2	3.6	5.7	1.2	3.2	6.2	0.4	47.4	39.7	19.9
Po Ro Conc 1-3	280.9	13.9	0.18	1.00	33.6	65.2	0.53	1.57	85.5	12.4	2.5	11.6	28.0	2.5	8.0	31.0	3.1			
Cu/Ni Ro Conc 1-3&Po Ro Conc 1-3	748.1	37.0	2.68	2.90	34.6	59.8	7.78	7.00	76.8	8.44	98.5	90.4	76.6	98.5	94.9	74.0	5.6			
Ni Conc (Cu 1st Cl tails, Cu Ro Tails)		5.1	2.92	11.6	34.5	51.0	8.47	31.4	55.0	5.12	14.9	50.0	10.6	14.9	59.1	7.3	0.5			
Ni Conc (Cu 1st Cl tails, Cu Ro Tails, Po 2nd Cl Conc)		5.7	2.68	10.6	34.8	52.0	7.76	28.5	58.8	4.92	12.5	50.9	11.9	15.2	59.9	8.8	0.5			
Ni Conc (Cu 1st Cl tails, Cu Ro Tails, Po 1st Cl Conc)		7.8	2.07	8.16	34.8	54.9	6.01	21.8	66.4	5.88	16.1	53.6	16.3	16.1	62.2	13.5	0.8			

Test: F20 Project: 18559-01 Date: July 22, 2021 Operator: Deepak

Purpose: Similar to F16, clean Po Ro Conc and Cu/Ni CI tails separately
 Procedure: As outlined below.

Feed: 2kg SN Comp -10 mesh Freezer/SEC-11C

Grind: 20 minutes at 65% solids in 2 kg Rod Mill # 3 P₈₀ =
 Regrind: 12 minutes at 50% solids in 2 kg Rod Mill for Cu/Ni R.Conc Cu/Ni Tails 1st CI Tails P₈₀ = 49.7 µm
 3 minutes at 50% solids in Attrition Mill for Po R.Conc - Ceramic balls P₈₀ = 127 µm

Conditions:

Stage	Lime	Reagents added, grams per tonne					Time, minutes			pH	ORP, mV
		CuSO4	Na2SO3	DETA	PAX	MIBC*	Grind	Cond.	Froth		
Grind	625				5		20			8.9	128
Cu/Ni Rougher No. 1	10					5		1	2	9.0	107
Cu/Ni Rougher No. 2	5				5	5		1	2	9.0	145
Cu/Ni Rougher No. 3	5				5	5		1	2	9.0	154
Target 20 wt% ... ~ 96.5% Cu, 75% Ni											
Regrind (2kg Rod Mill)	225		0	25	2		12			9.4	148
Cu/Ni 1st Cleaner No.1	15							1	9.4	9.5	138
Cu/Ni 1st Cleaner No.2	25				3			1	3	9.5	130
Target pH 9.5											
Cu/Ni Cleaner Scav	20				2			1	3	9.5	135
Po Rougher No. 1	-				5			1	3	natural pH	176
Po Rougher No. 2	-				5	5		1	5	natural pH	181
Po Rougher No. 3	-				5	5		1	5	natural pH	191
Po Cleaning on (Po Ro Con 1-3)											
Regrind on Po Ro Con 1-3 only											
Regrind (Attrition Mill, Ceramic balls)	200		0		0		3			10.5	58
Target pH 9.0											
Po 1st Cleaner-1	0			50	4			1	1	10.5	58
Po 1st Cleaner-2	0				2			1	1	10.2	85
Po 1st Cleaner-3	0				3			1	1		
Po 2nd Cleaner	0			5	1			1	3	9.0	148
Cleaning on Cu/Ni Cleaner Scav Tails											
Cu/Ni Tails 1st Cleaner-1	20			50	2			1	2	9.0	128
Cu/Ni Tails 1st Cleaner-2	0				2			1	2	9.0	145
Cu/Ni Tails 1st Cleaner-3	5				2			1	2	9.0	158
Cu/Ni Tails 2nd Cleaner	5			5	1			1	2	9.0	137
Total	535	0	0	135	49	25		17	48.4		

* Add as required.

Stage	Rougher/Scavenger	Po Rougher	Cu/Ni 1st/2nd Cleaner	Po 1st & 2nd Cl
Flotation Cell	2 kg float cell	2 kg float cell	500g/250g float cell	250g float cell
Speed: r.p.m.	1800	1800	1500/1200	1200

Metallurgical Balance

Product	Weight		Assays, %								% Distribution						
	g	%	Cu	Ni	S	Other	Cp	Pn	Po	Ga	Cu	Ni	S	Cp	Pn	Po	Ga
Cu/Ni 1st Cleaner Conc	122.1	6.1	15.0	9.58	35.4	40.0	43.5	26.2	30.0	0.36	90.0	50.3	12.7	90.0	60.6	4.6	0.0
Cu/Ni 1st Cleaner Scav Conc	17.4	0.9	2.98	8.24	36.2	52.6	8.64	22.0	67.4	2.05	2.5	6.2	1.8	2.5	7.2	1.5	0.0
Cu/Ni Tails 2nd Cleaner Conc	20.5	1.0	1.42	5.01	37.8	55.8	4.12	12.8	83.5	-0.4	1.4	4.4	2.3	1.4	5.0	2.2	0.0
Cu/Ni Tails 2nd Cleaner Tails	15.5	0.8	0.61	2.20	36.5	60.7	1.77	4.87	89.0	4.34	0.5	1.5	1.7	0.5	1.4	1.8	0.1
Cu/Ni Tails 1st Cleaner Tails	223.3	11.1	0.16	0.92	34.8	64.1	0.46	1.31	88.8	9.38	1.8	8.8	22.8	1.8	5.6	25.2	1.9
Po 2nd Cleaner Conc	60.3	3.0	0.32	1.84	38.5	59.3	0.93	3.78	95.9	-0.62	0.9	4.8	6.8	0.9	4.3	7.3	0.0
Po 2nd Cleaner Tails	47.7	2.4	0.18	1.26	37.7	60.9	0.52	2.17	95.6	1.72	0.4	2.6	5.3	0.4	2.0	5.8	0.1
Po 1st Cleaner Tails	129.3	6.4	0.14	1.07	34.0	64.8	0.41	1.76	86.4	11.4	0.9	6.0	12.9	0.9	4.3	14.2	1.3
Po Ro Tails	1379.2	68.4	0.02	0.26	8.4	91.3	0.06	0.37	21.4	78.1	1.5	15.4	33.9	1.5	9.6	37.5	96.6
Head (Calc.)	2015.3	100	1.01	1.15	16.9	80.9	2.93	2.62	39.1	55.3	100	100	100	100	100	100	100
Head (Dir.)			1.07	1.17	16.5	81.3	3.10	2.69	37.7	56.5							

Combined Products

Product	g	%	Stage Recovery																	
			Cu	Ni	S	Other	Cp	Pn	Po	Ga	Cu	Ni	S	Cp	Pn	Po	Ga	Cp	Pn	Po
Cu/Ni 1st Cl Conc		6.1	15.0	9.58	35.4	40.0	43.5	26.2	30.0	0.36	90.0	50.3	12.7	90.0	60.6	4.6	0.0	93.6	76.0	13.2
Cu/Ni 1st Cl & Scav Conc		6.9	13.5	9.41	35.5	41.6	39.1	25.7	34.6	0.57	92.6	56.5	14.5	92.6	67.8	6.1	0.1	96.2	85.0	17.4
Cu/Ni Tails 2nd Cl Conc		1.0	1.42	5.01	37.8	55.8	4.12	12.8	83.5	-0.38	1.4	4.4	2.3	1.4	5.0	2.2	0.0	75.5	77.6	55.4
Cu/Ni Tails 1st Cl Conc		1.8	1.07	3.80	37.2	57.9	3.11	9.36	85.9	1.65	1.9	5.9	3.9	1.9	6.4	3.9	0.1	51.9	53.4	13.5
Cu/Ni 1st Cl Tails		12.9	0.29	1.32	35.1	63.3	0.83	2.43	88.4	8.31	3.7	14.7	26.7	3.7	11.9	29.1	1.9			
Cu/Ni Ro Conc 1-3		19.8	4.91	4.15	35.3	55.7	14.2	10.6	69.6	5.60	96.2	71.2	41.2	96.2	79.8	35.2	2.0			
Po 2nd Cleaner Conc		3.0	0.32	1.84	38.5	59.3	0.93	3.78	95.9	-0.62	0.9	4.8	6.8	0.9	4.3	7.3	0.0	69.2	68.8	55.9
Po 1st Cleaner Conc		5.4	0.26	1.58	38.1	60.0	0.75	3.07	95.8	0.41	1.4	7.4	12.1	1.4	6.3	13.1	0.0	60.6	59.2	48.1
Po Ro Conc 1-3		11.8	0.19	1.30	35.9	62.6	0.56	2.36	90.7	6.40	2.3	13.3	24.9	2.3	10.6	27.3	1.4			
Cu/Ni Ro Conc 1-3&Po Ro Conc 1-3		31.6	3.15	3.09	35.5	58.3	9.13	7.50	77.5	5.90	98.5	84.6	66.1	98.5	90.4	62.5	3.4			

Test: F21 Project: 18559-01 Date: July 27, 2021 Operator: Deepak

Purpose: Similar to F16/F19, Using S Comp
 Procedure: As outlined below.

Feed: 2kg S Comp -10 mesh Freezer/SEC-12C Box 115029

Grind: 22 minutes at 65% solids in 2 kg Rod Mill # 3 P₈₀ =
 Regrind: 12 minutes at 50% solids in 2 kg Rod Mill for Cu/Ni R.Conc Cu/Ni 1st CI Tails P₈₀ =
 minutes at 50% solids in Mill for Po R.Conc P o 1st CI Scav Tails P₈₀ = 40.8 µm
 minutes at 50% solids in Mill for Cu/Ni CI Scav Tails - Cu/Ni Tails 1st CI Tails P₈₀ = 48.7 µm

Conditions:

Stage	Lime	Reagents added, grams per tonne					Time, minutes					pH	ORP, mV
		Na2SO3	DETA	PAX	MIBC*	Grind	Cond.	Froth					
Grind	350			5		22					9.0	42	
Cu/Ni Rougher No. 1	0				0		1	1			9.0	42	
Cu/Ni Rougher No. 2	5			5	5		1	2			9.0	114	
Cu/Ni Rougher No. 3	15			7.5	2.5		1	2.5			9.0	153	
Regrind (2kg Rod Mill)	225	0	25	2		12					9.4	138	
Cu/Ni 1st Cleaner No.1	5						1	2			9.5	90	
Cu/Ni 1st Cleaner No.2	15			2			1	3			9.5	131	
Cu/Ni Cleaner Scav	30			2			1	3			9.5	131	
Cu/Ni 2nd Cleaner	45			1	0		1	4			9.5	108	
Po Rougher No. 1	-			10	5		1	3			natural pH	185	
Po Rougher No. 2	-			10	10		1	5			natural pH	188	
Po Rougher No. 3	-			10	10		1	5			natural pH	198	
Po Cleaning on (Po Ro Con 1-3)													
Regrind (Attrition Mill)	150		25			10					9.0	95	
Po 1st Cleaner-1	0			1+1	0		1	2			9.0	95	
Po 1st Cleaner-2	10			2			1	2			9.0	112	
Po 2nd Cleaner	5		5	1+1			1	2			9.0	98	
Po 3rd Cleaner	5		0	3+1			1	1+1			9.0	110	
Cleaning on Cu/Ni Cleaner Scav Tails													
Cu/Ni Tails 1st Cleaner-1	10		0	6			1	2			9.0	152	
Cu/Ni Tails 1st Cleaner-2	40		0	6			1	2			9.0	127	
CuSEP													
Polish Grind (Pepple mill)	900					7					11.6	18	
Cu Ro 1	0			0			1	2			11.6	18	
Cu Ro 2	0			1			1	2			11.7	-2	
Cu Ro Scav	0			1			1	2			11.6	10	
Cu 1st CI	0			0			1	3			11.5	22	
Cu 2nd CI	85			0			1	3			11.5	12	
Cu 3rd CI	110			0			1	2.5			11.5	13	
Total	1460	0	0	55	65.5	32.5					49.5		

Target 23.5 wt% ... ~ 98% Cu, 85% Ni

Target pH 9.5

Target pH 9.0

me

* Add as required.

Stage	Rougher/Scavenger	Po Rougher	Cu/Ni 1st/2nd Cleaner	Po 1st & 2nd CI
Flotation Cell	2 kg float cell	2 kg float cell	500g/250g float cell	250g float cell
Speed: r.p.m.	1800	1800	1500/1200	1200

Metallurgical Balance

Product	Weight		Assays, %								% Distribution						
	g	%	Cu	Ni	S	Other	Cp	Pn	Po	Ga	Cu	Ni	S	Cp	Pn	Po	Ga
Cu 3rd Cleaner Conc	64.4	3.2	33.0	0.22	35.0	31.8	95.7	0.56	3.47	0.31	55.5	0.8	9.7	55.5	0.9	0.5	0.0
Cu 3rd Cleaner Tails	7.0	0.3	26.5	0.72	34.2	38.6	76.8	1.75	17.5	3.94	4.8	0.3	1.0	4.8	0.3	0.3	0.0
Cu 2nd Cleaner Tails	6.8	0.3	23.8	1.70	34.1	40.4	69.0	4.41	22.1	4.53	4.2	0.7	1.0	4.2	0.7	0.3	0.0
Cu 1st Cleaner Tails	14.5	0.7	17.4	4.71	34.1	43.8	50.4	12.6	31.9	5.04	6.6	3.9	2.1	6.6	4.4	1.0	0.1
Cu Ro Scav Conc	20.6	1.0	17.5	2.99	34.3	45.2	50.7	7.80	36.3	5.18	9.4	3.5	3.0	9.4	3.9	1.6	0.1
Cu Ro Scav Tails	75.8	3.8	7.48	12.5	34.1	45.9	21.7	34.2	39.6	4.58	14.8	53.5	11.1	14.8	62.2	6.4	0.3
Cu/Ni 2nd CI Tails	43.4	2.2	0.78	2.68	35.6	60.9	2.26	6.26	85.0	6.43	0.9	6.6	6.6	0.9	6.5	7.9	0.2
Cu/Ni 1st Cleaner Scav Conc	61.4	3.1	0.61	2.15	37.4	59.8	1.77	4.70	91.5	2.03	1.0	7.5	9.8	1.0	6.9	12.0	0.1
Cu/Ni Tails 1st Cleaner Conc	95.7	4.8	0.19	1.10	37.7	61.0	0.55	1.72	95.9	1.78	0.5	5.9	15.5	0.5	4.0	19.6	0.1
Cu/Ni Tails 1st Cleaner Tails	111.7	5.6	0.13	0.60	23.3	76.0	0.38	0.81	59.5	39.3	0.4	3.8	11.2	0.4	2.2	14.2	3.2
Po 3rd Cleaner Conc	10.9	0.5	0.23	1.51	38.8	59.5	0.67	2.84	97.7	-1.2	0.1	0.9	1.8	0.1	0.7	2.3	0.0
Po 3rd Cleaner Tails	4.6	0.2	0.29	1.25	38.2	60.3	0.84	2.13	96.6	0.40	0.0	0.3	0.8	0.0	0.2	0.9	0.0
Po 2nd Cleaner Tails	16.5	0.8	0.44	1.21	33.9	64.5	1.28	2.17	85.0	11.5	0.2	1.1	2.4	0.2	0.9	3.0	0.1
Po 1st Cleaner Tails	109.2	5.4	0.21	0.82	30.8	68.2	0.61	1.17	78.4	19.8	0.6	5.1	14.4	0.6	3.1	18.2	1.6
Po Ro Tails	1361.4	67.9	0.03	0.08	1.65	98.2	0.08	0.10	4.1	95.7	1.0	6.2	9.6	1.0	3.1	12.0	94.3
Head (Calc.)	2003.9	100	1.91	0.88	11.6	85.6	5.54	2.08	23.4	69.0	100	100	100	100	100	100	100
Head (Dir.)			1.90	0.88	11.9	85.3	5.51	2.06	24.1	68.3							

Combined Products																		Stage Recovery		
																		Cp	Pn	Po
Cu 3rd Cleaner Conc		3.2	33.0	0.22	35.0	31.8	95.7	0.56	3.47	0.31	55.5	0.8	9.7	55.5	0.9	0.5	0.0	92.0	74.7	64.6
Cu 2nd Cleaner Conc		3.6	32.4	0.27	34.9	32.4	93.8	0.68	4.85	0.67	60.4	1.1	10.7	60.4	1.2	0.7	0.0	93.5	61.8	69.7
Cu 1st Cleaner Conc		3.9	31.6	0.39	34.9	33.1	91.6	1.00	6.34	1.01	64.6	1.7	11.7	64.6	1.9	1.1	0.1	90.7	30.0	51.8
Cu Ro Conc		4.6	29.4	1.07	34.7	34.8	85.2	2.82	10.3	1.64	71.2	5.6	13.8	71.2	6.3	2.0	0.1	74.6	8.7	20.4
Cu Ro & Scav Conc		5.7	27.2	1.42	34.7	36.7	78.9	3.73	15.1	2.28	80.6	9.1	16.8	80.6	10.1	3.6	0.2	84.5	14.0	36.3
Cu/Ni 2nd CI Conc		9.4	19.3	5.86	34.4	40.4	56.0	15.9	24.9	3.20	95.4	62.6	27.9	95.4	72.4	10.0	0.4	99.1	91.7	56.0
Cu/Ni 1st CI Conc		11.6	15.9	5.27	34.7	44.2	46.0	14.1	36.1	3.80	96.3	69.2	34.5	96.3	78.9	17.9	0.6	98.1	85.8	28.1
Cu/Ni 1st CI & Scav Conc		14.7	12.7	4.62	35.2	47.5	36.7	12.2	47.7	3.43	97.3	76.7	44.4	97.3	85.8	29.9	0.7	99.1	93.3	47.0
Cu/Ni 1st CI & Scav Conc & Tails 1st CI Conc		19.4	9.60	3.75	35.8	50.8	27.8	9.59	59.5	3.03	97.8	82.6	59.8	97.8	89.8	49.4	0.9	99.6	97.6	77.7
Cu/Ni Ro Conc 1-3		25.0	7.49	3.05	33.0	56.4	21.7	7.64	59.5	11.1	98.2	86.4	71.0	98.2	92.0	63.6	4.0			
Po 3rd Cleaner Conc		0.5	0.23	1.51	38.8	59.5	0.67	2.84	97.7	-1.2	0.1	0.9	1.8	0.1	0.7	2.3	0.0	65.3	75.9	70.6
Po 2nd Cleaner Conc		0.8	0.25	1.43	38.6	59.7	0.72	2.63	97.4	-0.8	0.1	1.3	2.6	0.1	1.0	3.2	0.0	11.3	19.9	13.2
Po 1st Cleaner Conc		1.6	0.35	1.32	36.2	62.1	1.01	2.39	91.0	5.6	0.3	2.4	5.0	0.3	1.8	6.2	0.1	32.6	37.4	25.4
Po Ro Conc 1-3		7.0	0.24	0.93	32.0	66.8	0.70	1.45	81.3	16.6	0.9	7.4	19.4	0.9	4.9	24.5	1.7			
Cu/Ni Ro Conc 1-3&Po Ro Conc 1-3		32.1	5.90	2.58	32.8	58.7	17.1	6.28	64.3	12.3	99.0	93.8	90.4	99.0	96.9	88.0	5.7			

Test: F22 **Project:** 18559-01 **Date:** July 27, 2021 **Operator:** Deepak

Purpose: Similar to F16/F19, Using P Comp
Procedure: As outlined below.

Feed: 2kg P Comp -10 mesh Freezer/SEC-11C Box 115025

Grind: 22 minutes at 65% solids in 2 kg Rod Mill # 3 P₈₀ = 147 µm
Regrind: 12 minutes at 50% solids in 2 kg Rod Mill for Cu/Ni R.Conc Cu/Ni 1st Cl Tails P₈₀ = 37.8 µm
 minutes at 50% solids in Mill for Po R.Conc - P o 1st Cl Scav Tails P₈₀ = 40.4 µm
 minutes at 50% solids in Mill for Cu/Ni Cl Scav Tails - P₈₀ =

Conditions:

Stage	Reagents added, grams per tonne					Time, minutes			pH	ORP, mV
	Lime	DETA	PAX	MIBC*	Grind	Cond.	Froth			
Grind	550		5		20				8.9	145
Cu/Ni Rougher No. 1	20			5		1	1		9.0	108
Cu/Ni Rougher No. 2	15		5	2.5		1	2		9.0	128
Cu/Ni Rougher No. 3	20		5	5		1	2		9.0	142
Regrind (2kg Rod Mill)	150		25	3	12				9.3	74
Cu/Ni 1st Cleaner No.1	5					1	2		9.5	44
Cu/Ni 1st Cleaner No.2	5			3		1	3		9.5	120
Cu/Ni Cleaner Scav	35			2		1	3		9.5	123
Cu/Ni 2nd Cleaner	5			0	0	1	4		9.5	120
Po Rougher No. 1	-			10	5	1	3		natural pH	153
Po Rougher No. 2	-			10	10	1	5		natural pH	160
Po Rougher No. 3	-			10	10	1	5		natural pH	171
Po Cleaning on (Po Ro Con 1-3)										
Regrind (Pepple Mill)	150		25		10				9.6	118
Po 1st Cleaner-1	0			1+1	0	1	2		9.0	118
Po 1st Cleaner-2	5			2		1	2		9.5	151
Po 1st Cleaner Scavenger	0			0	10	1	2			
Po 2nd Cleaner	5			0	2	1	2+1		9.0	139
Po 3rd Cleaner	15			0	0	1	2		9.0	140
Cleaning on 1st/2nd/3rd Cleaner Scav Tails										
	300			0					9.9	128
Cu/Ni Tails 1st Cleaner-1	5			0	6	1	2		9.9	146
Cu/Ni Tails 1st Cleaner-2	5			0	7	1	2		9.0	154
CuSEP										
Polish Grind (Pepple mill)	350				3				11.7	2
Cu Ro 1	0			0		1	2		11.7	2
Cu Ro Scav	0			1		1	1		11.8	-22
Cu 1st Cl	80			0		1	2		11.5	11
Cu 2nd Cl	145			0		1	2		11.5	21
Total	1170	0	0	50	76	37.5		47		

* Add as required.

Stage	Rougher/Scavenger	Po Rougher	Cu/Ni 1st/2nd Cleaner	Po 1st & 2nd Cl
Flotation Cell	2 kg float cell	2 kg float cell	500g/250g float cell	250g float cell
Speed: r.p.m.	1800	1800	1500/1200	1200

Target pH 9.5

Target pH 9.0

Metallurgical Balance

Product	Weight		Assays, %							% Distribution							
	g	%	Cu	Ni	S	Other	Cp	Pn	Po	Ga	Cu	Ni	S	Cp	Pn	Po	Ga
F22 Cu 2nd Cleaner Conc	5.7	0.3	32.2	0.17	33.7	33.9	93.3	0.44	2.31	3.92	21.5	0.1	0.9	21.5	0.1	0.0	0.0
F22 Cu 2nd Cleaner Tails	6.9	0.3	30.6	0.78	33.0	35.6	88.7	2.12	3.3	5.92	24.7	0.3	1.0	24.7	0.4	0.0	0.0
F22 Cu 1st Cleaner Tails	5.7	0.3	19.7	7.18	34.0	39.1	57.1	19.7	19.5	3.69	13.1	2.6	0.9	13.1	3.2	0.2	0.0
F22 Cu Ro Scav Conc	3.5	0.2	24.3	4.21	35.0	36.5	70.4	11.5	17.1	1.05	9.9	0.9	0.6	9.9	1.1	0.1	0.0
F22 Cu Ro Scav Tails	33.6	1.7	3.18	16.3	39.2	41.3	9.2	44.5	55.3	-9.02	12.5	35.2	6.0	12.5	42.6	3.6	-0.2
F22 Cu/Ni 2nd CI Tails	15.9	0.8	1.16	5.26	39.2	54.4	3.4	13.4	87.3	-4.04	2.2	5.4	2.9	2.2	6.1	2.7	0.0
F22 Cu/Ni 1st Cleaner Scav Conc	8.1	0.4	1.42	7.82	40.2	50.6	4.12	20.6	83.0	-7.73	1.3	4.1	1.5	1.3	4.8	1.3	0.0
F22 Cu/Ni Tails 1st Cleaner Conc	24.9	1.2	0.69	3.36	42.2	53.8	2.00	7.94	101.0	-10.9	2.0	5.4	4.8	2.0	5.6	4.9	-0.2
F22 Cu/Ni Tails 1st Cleaner Tails	132.3	6.6	0.31	1.14	26.5	72.1	0.90	2.23	66.1	30.8	4.8	9.7	16.1	4.8	8.4	17.0	2.8
F22 Po 3rd Cleaner Conc	12.2	0.6	0.73	4.01	43.8	51.5	2.12	9.71	103.5	-15.3	1.0	3.1	2.5	1.0	3.4	2.5	-0.1
F22 Po 3rd Cleaner Tails	4.4	0.2	0.58	4.17	37.9	57.4	1.68	10.4	88.0	-0.1	0.3	1.2	0.8	0.3	1.3	0.8	0.0
F22 Po 2nd Cleaner Tails	15.1	0.7	0.25	1.97	34.5	63.3	0.72	4.28	85.3	9.71	0.4	1.9	2.4	0.4	1.8	2.5	0.1
F22 Po 1st Cleaner Scav Conc	8.9	0.4	0.36	2.53	35.4	61.7	1.04	5.83	86.0	7.1	0.4	1.4	1.4	0.4	1.5	1.5	0.0
F22 Po 1st Cleaner Scav Tails	212.2	10.5	0.06	0.81	29.3	69.8	0.19	1.19	74.9	23.7	1.6	11.0	28.5	1.6	7.2	31.0	3.5
F22 Po Ro Tails	1526.2	75.7	0.02	0.18	4.25	95.5	0.07	0.29	10.7	88.9	4.3	17.6	29.8	4.3	12.5	31.9	94.1
Head (Calc.)	2015.6	100	0.42	0.77	10.8	88.0	1.23	1.74	25.5	71.5	100	100	100	100	100	100	100
Head (Dir.)			0.42	0.79	10.4	85.3	1.22	1.81	24.4	69.5							

Combined Products	g	%	Assays, %													Stage Recovery				
			Cu	Ni	S	Other	Cp	Pn	Po	Ga	Cu	Ni	S	Cp	Pn	Po				
Cu 2nd Cleaner Conc		0.3	32.2	0.17	33.7	33.9	93.3	0.44	2.31	3.92	21.5	0.1	0.9	21.5	0.1	0.0	0.0	46.5	14.6	36.9
Cu 1st Cleaner Conc		0.6	31.3	0.50	33.3	34.9	90.8	1.36	2.83	5.02	46.1	0.4	1.9	46.1	0.5	0.1	0.0	77.9	13.2	24.3
Cu Ro Conc		0.9	27.7	2.58	33.5	36.2	80.3	7.06	8.04	4.60	59.2	3.0	2.8	59.2	3.7	0.3	0.1	72.5	7.8	7.1
Cu Ro & Scav Conc		1.1	27.2	2.84	33.8	36.2	78.7	7.77	9.5	4.03	69.2	4.0	3.4	69.2	4.8	0.4	0.1	84.7	10.2	10.0
Cu/Ni 2nd CI Conc		2.7	12.6	11.0	37.1	39.3	36.6	30.1	37.3	-3.88	81.7	39.2	9.4	81.7	47.5	4.0	-0.1	97.4	88.7	59.8
Cu/Ni 1st CI Conc		3.5	10.1	9.72	37.5	42.7	29.2	26.3	48.4	-3.92	83.8	44.5	12.3	83.8	53.5	6.7	-0.2	98.4	91.8	83.7
Cu/Ni 1st CI & Scav Conc		3.9	9.18	9.53	37.8	43.5	26.6	25.8	51.9	-4.31	85.2	48.6	13.8	85.2	58.3	8.0	-0.2	92.6	80.6	26.8
Cu/Ni 1st CI & Scav Conc & Tails 1st CI Conc		5.2	7.15	8.06	38.9	45.9	20.7	21.5	63.7	-5.89	87.2	54.0	18.6	87.2	63.9	12.9	-0.4	94.8	88.4	43.2
Cu/Ni Ro Conc 1-3		11.7	3.33	4.19	31.9	60.5	9.64	10.7	65.0	14.6	92.0	63.6	34.7	92.0	72.3	30.0	2.4			
Po 3rd Cleaner Conc		0.6	0.73	4.01	43.8	51.5	2.12	9.71	103.5	-15.3	1.0	3.1	2.5	1.0	3.4	2.5	-0.1	77.7	72.2	76.5
Po 2nd Cleaner Conc		0.8	0.69	4.05	42.2	53.0	2.00	9.88	99.4	-11.3	1.3	4.3	3.2	1.3	4.7	3.2	-0.1	75.2	71.7	56.2
Po 1st Cleaner Conc		1.6	0.48	3.06	38.6	57.9	1.39	7.21	92.7	-1.3	1.8	6.2	5.6	1.8	6.5	5.7	0.0	47.6	42.9	15.0
Po 1st Cleaner & Scav Conc		2.0	0.45	2.94	37.9	58.7	1.32	6.91	91.2	0.6	2.2	7.7	7.1	2.2	8.0	7.2	0.0	57.6	52.6	18.9
Po Ro Conc 1-3		12.5	0.13	1.15	30.7	68.0	0.37	2.11	77.5	20.0	3.7	18.7	35.6	3.7	15.2	38.2	3.5			
Cu/Ni Ro Conc 1-3&Po Ro Conc 1-3		24.3	1.67	2.62	31.3	64.4	4.85	6.27	71.5	17.4	95.7	82.4	70.2	95.7	87.5	68.1	5.9			

Test: F23 **Project:** 18559-01 **Date:** July 29, 2021 **Operator:** Deepak

Purpose: Based on F2, no DETA in the regrind.

Procedure: As outlined below.

Feed: 2kg SN Comp -10 mesh Freezer\SEC-11C

Grind: 34 minutes at 65% solids in 2 kg Rod Mill # 3 P₈₀ =
Regrind 12 minutes at 50% solids in 2 kg Rod Mill for Cu/Ni R.Conc Cu/Ni 1st CI Tails P₈₀ = 41.5 µm Malvern
 20 minutes at 50% solids in 2 kg Attrition Mill for Po R.Conc Po 1st CI Scav Tails P₈₀ = 41.3 µm Malvern

Conditions:

Stage	Reagents added, grams per tonne						Time, minutes			pH	ORP, mV
	Lime		PAX	MIBC*			Grind	Cond.	Froth		
Grind	625		5				34			9.1	107
Cu/Ni Rougher No. 1	0			0				1	1	9.0	61
Cu/Ni Rougher No. 2	0		5	0				1	2	8.9	127
Cu/Ni Rougher No. 3	0		5	0				1	2	8.9	132
Regrind (2kg Rod Mill)	200		1				12			9.1	166
Cu/Ni 1st Cleaner No.1	10			0				1	2	9.5	150
Cu/Ni 1st Cleaner No.2	5		1	0				1	2	9.5	141
Cu/Ni 1st Cleaner No.3	20		1	0				1	3	9.5	144
Cu/Ni 2nd Cleaner No.1									4	9.5	76
Cu/Ni 2nd Cleaner No.2			1	2.5					2	9.5	109
Cu/Ni 2nd Cleaner No.3			1							9.8	121
Po Cleaning on (Po Ro Con 1-3)											
<i>Regrind on Po Ro Con 1-3 only</i>											
Regrind (Attrition Mill, Ceramic balls)	250		0				12			9.0	90
Po 1st Cleaner-1	0		1					1	1	10.3	90
Po 1st Cleaner-2	10		1					1	1	9.5	144
Po 1st Cleaner-3	0		2					1	1		
Po 1st Cleaner-4	0		2					1	1		
Po Cleaner Scavenger			5					1	1		
Po 2nd Cleaner	15		1					1	2.5	9.0	151
Po 3rd Cleaner	15		0+1					1	1+1	9.0	170
Total	510	0	32	2.5	0	0		12	25.5		

Target 9.5

Target 9.0

* Add as required.

Stage	Rougher/Scavenger	Po Rougher	Cu/Ni 1st/2nd Cleaner	Po 1st & 2nd CI
Flotation Cell	2 kg float cell	2 kg float cell	500g/250g float cell	250g float cell
Speed: r.p.m.	1800	1800	1500/1200	1200

Metallurgical Balance

Product	Weight		Assays, %								% Distribution									
	g	%	Cu	Ni	S	Other	Cp	Pn	Po	Ga	Cu	Ni	S	Cp	Pn	Po	Ga			
F23 Cu/Ni 2nd CI Conc-1	107.3	5.3	16.1	9.34	35.4	39.2	46.7	25.6	27.6	0.16	83.3	41.6	11.7	83.3	49.1	4.0	0.0			
F23 Cu/Ni 2nd CI Conc-2	16.2	0.8	3.11	9.83	36.9	50.2	9.01	26.4	65.0	-0.44	2.4	6.6	1.8	2.4	7.7	1.4	0.0			
F23 Cu/Ni 2nd CI Conc-3	13.2	0.7	1.23	5.96	37.6	55.2	3.57	15.4	81.2	-0.19	0.8	3.3	1.5	0.8	3.6	1.4	0.0			
F23 Cu/Ni 2nd CI Tails	14.4	0.7	0.65	2.84	34.9	61.6	1.88	6.73	83.2	8.22	0.5	1.7	1.6	0.5	1.7	1.6	0.1			
F23 Cu/Ni 1st CI Tails	233.9	11.5	0.83	2.25	33.7	63.2	2.41	5.12	81.0	11.5	9.4	21.8	24.3	9.4	21.4	25.6	2.3			
F23 Po 3rd CI Conc	12.1	0.6	0.81	3.09	36.3	59.8	2.35	7.39	85.8	4.45	0.5	1.6	1.4	0.5	1.6	1.4	0.0			
F23 Po 3rd CI Tails	18.3	0.9	0.36	1.76	34.9	63.0	1.04	3.68	86.5	8.73	0.3	1.3	2.0	0.3	1.2	2.1	0.1			
F23 Po 2nd CI Tails	66.0	3.3	0.22	1.38	34.1	64.3	0.64	2.63	85.7	11.0	0.7	3.8	6.9	0.7	3.1	7.7	0.6			
F23 Po 1st CI Scav Conc	21.4	1.1	0.21	1.58	34.9	63.3	0.61	3.17	87.4	8.84	0.2	1.4	2.3	0.2	1.2	2.5	0.2			
F23 Po 1st CI Scav Tails	272.8	13.5	0.06	0.76	31.3	67.9	0.17	0.98	80.3	18.5	0.8	8.6	26.3	0.8	4.8	29.6	4.3			
F23 Po Ro Tails	1252.0	61.7	0.02	0.16	5.21	94.6	0.06	0.20	13.3	86.4	1.2	8.3	20.1	1.2	4.4	22.5	92.3			
Head (Calc.)	2027.6	100	1.02	1.19	16.0	81.8	2.97	2.75	36.5	57.8	100	100	100	100	100	100	100			
Head (Dir.)			1.07	1.17	16.5	81.3	3.10	2.69	37.7	56.5										
																	Stage Recovery			
																	Cp	Pn	Po	
Cu/Ni 2nd CI Conc 1		5.3	16.1	9.34	35.4	39.2	46.7	25.6	27.6	0.2	83.3	41.6	11.7	83.3	49.1	4.0	0.0	95.8	79.0	47.1
Cu/Ni 2nd CI Conc 1-2		6.1	14.4	9.40	35.6	40.6	41.7	25.7	32.5	0.1	85.7	48.2	13.6	85.7	56.8	5.4	0.0	98.6	91.3	63.9
Cu/Ni 2nd CI Conc 1-3		6.7	13.1	9.07	35.8	42.0	38.0	24.7	37.2	0.1	86.5	51.5	15.1	86.5	60.5	6.9	0.0	99.5	97.2	80.9
Cu/Ni 1st CI Conc 1-3		7.5	11.9	8.48	35.7	43.9	34.6	23.0	41.6	0.8	86.9	53.2	16.6	86.9	62.2	8.5	0.1	90.3	74.4	24.9
Cu/Ni Ro Conc 1-3		19.0	5.19	4.69	34.5	55.6	15.0	12.1	65.5	7.3	96.3	75.0	41.0	96.3	83.6	34.1	2.4			
Po 3rd Cleaner Conc		0.6	0.81	3.09	36.3	59.8	2.35	7.39	85.8	4.4	0.5	1.6	1.4	0.5	1.6	1.4	0.0	59.8	57.0	39.6
Po 2nd Cleaner Conc		1.5	0.54	2.29	35.5	61.7	1.56	5.16	86.3	7.0	0.8	2.9	3.3	0.8	2.8	3.5	0.2	53.0	47.4	31.7
Po 1st Cleaner Conc		4.8	0.32	1.67	34.5	63.5	0.93	3.43	85.9	9.7	1.5	6.7	10.3	1.5	5.9	11.2	0.8	59.7	49.6	25.8
Po 1st Cleaner & Scav Conc		5.8	0.30	1.65	34.6	63.5	0.87	3.38	86.2	9.6	1.7	8.1	12.6	1.7	7.1	13.7	1.0	68.4	59.8	31.7
Po Ro Conc 1-3		19.3	0.13	1.03	32.3	66.5	0.38	1.71	82.1	15.8	2.5	16.7	38.9	2.5	11.9	43.4	5.3			
Cu/Ni Ro Conc 1-3&Po Ro Conc 1-3		38.3	2.64	2.85	33.4	61.1	7.66	6.88	73.9	11.6	98.8	91.7	79.9	98.8	95.6	77.5	7.7			
Po Ro Feed		81.0	0.05	0.37	11.7	87.9	0.14	0.56	29.7	69.6	3.7	25.0	59.0	3.7	16.4	65.9	97.6			

Test: F37 **Project:** 18559-01 **Date:** August 31, 2021 **Operator:** Deepak

Purpose: Similar to F36, with P Comp

Product Wet Weigl
Po Ro Conc 392.34
Cu/Ni 1st Cl Sc Tails 197.39

Procedure: As outlined below.

Feed: 2kg P Comp -10 mesh Freezer/SEC-11C Box 115025

Grind: 39 minutes at 65% solids in 2 kg Rod Mill # 3 P₈₀ =
Regrind 18 minutes at 50% solids in 2 kg Rod Mill for Cu/Ni R.Conc Cu/Ni 1st Cl Feed P₈₀ = 25.5 µm Malvern
30 minutes at 50% solids in 2 kg Attrition Mill for Po 1st Cl Po 1st Cl Scav Feed P₈₀ = 35.6 µm Malvern
Po 1st Cl Scav Tails P₈₀ = 34.9 µm Malvern

Note: 1. Assay: Cu, Ni, S, Pt, Pd, Au
check size on the feed

Conditions:

Stage	Reagents added, grams per tonne						Time, minutes				pH	ORP, mV
	Lime	DETA	PAX	MIBC*	CuSO4	Grind	Cond.	Froth				
Grind	550		5			39				9.0	144	
Cu/Ni Rougher No. 1	0		5	0				1	1	9.0	144	
Cu/Ni Rougher No. 2	0		5	5				1	2	~9	153	
Cu/Ni Rougher No. 3	0		5	2.5				1	2	~9	160	
Po Rougher No. 1	0		20	2.5				1	3	natural pH	161	
Po Rougher No. 2	0		20	5				1	3	natural pH	169	
Po Rougher No. 3	0		20	10	50			1	3	natural pH	180	
Po Rougher Scav	0		30		50			1	3	natural pH	180	
Regrind Cu/Ni Ro Conc (2kg Rod Mill)	150	25	1			18				8.9	149	
Cu/Ni 1st Cleaner No.1	10		0					1	2	9.5	102	
Cu/Ni 1st Cleaner No.2	0		6					1	2	~	136	
Cu/Ni 1st Cleaner Scav	40		2+5					1	2+2	9.5	113	
Regrind Cu/Ni 1st Cl Scav 1 Tails + Po Ro Conc 1-3 (Attrition Mill)	200					30				9.4	135	
Po 1st Cleaner-1	5		2					1	2	9.5	122	
Po 1st Cleaner-2	0		2					1	2	~	~	
Po 1st Cleaner Scav	0		0					1	2	~	174	
Po 2nd Cleaner	5		0					1	3	9.0	152	
Total	410	25	0	121	25	0		14	30			

Keep Cu/Ni and Po separate

Target ~40 um
Target 9.5

Target ~15 um
Target 9.5

Stage	Rougher/Scavenge	Po Rougher	Cu/Ni 1st/2nd Cleaner	Po 1st & 2nd Cl
Flotation Cell	2 kg float cell	2 kg float cell	500g/250g float cell	250g float cell
Speed: r.p.m.	1800	1800	1500/1200	1200

Metallurgical Balance

Product	Weight		Assays, %								% Distribution						
	g	%	Cu	Ni	S	Other	Cp	Pn	Po	Ga	Cu	Ni	S	Cp	Pn	Po	Ga
F37 Cu/Ni 1st Cleaner Conc-1	30.6	1.5	16.6	11.2	35.7	36.5	48.1	30.8	22.6	-1.5	62.2	22.6	5.4	62.2	27.3	1.5	0.0
F37 Cu/Ni 1st Cleaner Conc-2	22.9	1.1	6.43	12.7	37.9	43.0	18.6	34.6	51.9	-5.1	18.0	19.2	4.3	18.0	23.0	2.5	-0.1
F37 Cu/Ni 1st Cleaner Scav Conc	18.6	0.9	2.11	8.85	40.0	49.0	6.12	23.5	78.2	-7.8	4.8	10.8	3.7	4.8	12.7	3.1	-0.1
F37 Po 2nd Cleaner Conc	37.8	1.9	0.93	3.38	45.9	49.8	2.70	7.88	110.0	-20.6	4.3	8.4	8.5	4.3	8.6	8.7	-0.5
F37 Po 2nd Cleaner Tails	36.2	1.8	0.32	1.91	33.5	64.3	0.93	4.15	82.6	12.3	1.4	4.6	6.0	1.4	4.4	6.3	0.3
F37 Po 1st Cleaner Scav Conc	19.1	1.0	0.47	2.38	36.4	60.8	1.36	5.38	88.7	4.6	1.1	3.0	3.4	1.1	3.0	3.6	0.1
F37 Po 1st Cleaner Scav Tails	398.5	19.9	0.09	0.81	31.1	68.0	0.27	1.13	79.6	19.0	4.5	21.3	61.0	4.5	13.1	66.5	5.2
F37 Po Ro Scav Conc	44.5	2.2	0.09	0.86	28.7	70.4	0.26	1.35	73.2	25.2	0.5	2.5	6.3	0.5	1.7	6.8	0.8
F37 Po Ro Tails	1397.7	69.7	0.02	0.08	0.21	99.7	0.05	0.15	0.4	99.4	3.1	7.6	1.4	3.1	6.2	1.1	94.5
Head (Calc.)	2005.9	100	0.41	0.76	10.1	88.7	1.18	1.72	23.8	73.3	100	100	100	100	100	100	100
Head (Dir.)			0.42	0.79	10.4	88.4	1.22	1.80	24.4	72.6							

Combined Products

Cu/Ni 1st CI Conc 1	30.6	1.5	16.6	11.2	35.7		48.1	30.8	22.6	-1.5	62.2	22.6	5.4	62.2	27.3	1.5	0.0
Cu/Ni 1st CI Conc 1-2	53.5	2.7	12.2	11.8	36.6		35.5	32.4	35.1	-3.0	80.3	41.7	9.7	80.3	50.3	3.9	-0.1
Cu/Ni 1st CI & Scav Conc	72.1	3.6	9.63	11.1	37.5		27.9	30.1	46.2	-4.3	85.1	52.6	13.3	85.1	63.0	7.0	-0.2
Po 2nd CI Conc	37.8	1.9	0.93	3.38	45.9		2.70	7.88	110.0	-20.6	4.3	8.4	8.5	4.3	8.6	8.7	-0.5
Po 1st CI Conc	74.0	3.7	0.63	2.66	39.8		1.83	6.05	96.6	-4.5	5.7	13.0	14.5	5.7	13.0	15.0	-0.2
Po 1st CI & Scav Conc	93.1	4.6	0.60	2.60	39.1		1.73	5.91	95.0	-2.6	6.8	16.0	17.9	6.8	16.0	18.6	-0.2
Cu/Ni 1st CI Tails & Po Ro Conc 1-3	491.6	24.5	0.19	1.15	32.6		0.55	2.04	82.5	14.9	11.4	37.2	79.0	11.4	29.0	85.1	5.0
Cu/Ni Ro Conc 1-3 & Po Ro Conc	563.7	28.1	1.40	2.42	33.2		4.05	5.63	77.8	12.5	96.4	89.8	92.3	96.4	92.0	92.1	4.8
Cu/Ni 1st CI & Scav Conc & Po 1st CI & Sca	608.2	30.3	1.30	2.30	32.9		3.77	5.3	77.5	13.4	96.9	92.4	98.6	96.9	93.8	98.9	5.5

Test: F39 **Project:** 18559-01 **Date:** September 14, 2021 **Operator:** Deepak

Purpose: Similar to F37, with SN Comp

Procedure: As outlined below.

Feed: 2kg SN Comp -10 mesh Freezer/SEC-11C

Grind: 34 minutes at 65% solids in 2 kg Rod Mill # 3 P₈₀ =
Regrind 22.5 minutes at 50% solids in 2 kg Rod Mill for Cu/Ni R.Conc Cu/Ni 1st Cl Feed P₈₀ = 26.7 µm Malvern
 15+15 minutes at 50% solids in 2 kg Attrition Mill for Po 1st Cl Po 1st Cl Scav Feed P₈₀ = 25 µm Malvern

Product **Wet Weigl**
 Cu/Ni R. Conc 317
 Po R. Conc 566
 Cu/Ni Cl Sc Tails 242.6

Note: 1. Assay: Cu, Ni, S
 check size on the feed

Conditions:

Stage	Reagents added, grams per tonne						Time, minutes				pH	ORP, mV
	Lime	DETA	PAX	MIBC*	CuSO4	Grind	Cond.	Froth				
Grind	625		5			34				9.4	161	
Cu/Ni Rougher No. 1	0		5	5			1	1		9.4	168	
Cu/Ni Rougher No. 2	0		5	5			1	2		~9	172	
Cu/Ni Rougher No. 3	0		5	5			1	2		~9	177	
Po Rougher No. 1	0		10				1	3		natural pH	133	
Po Rougher No. 2	0		10	5			1	5*		natural pH	136	
Po Rougher No. 3	0		10	5			1	5*		natural pH	149	
Po Rougher Scav	0		30		50		1	3		natural pH	169	
Regrind Cu/Ni Ro Conc (2kg Rod Mill)	250	25	2			22.5				9.1	183	
Cu/Ni 1st Cleaner No.1	25		2				1	2		9.5	183	
Cu/Ni 1st Cleaner No.2	0		3				1	3		~	178	
Cu/Ni 1st Cleaner Scav	30		5				1	3		9.5	135	
Regrind Cu/Ni 1st Cl Scav 1 Tails + Po Ro Conc 1-3 (Attrition Mill)	Split to 2											
	100+100	25				15+15				9.1	138	
Po 1st Cleaner-1	0		4				1	1		9.1	138	
Po 1st Cleaner-2	0		2				1	2		~	~	
Po 2nd Cleaner	5		1				1	2		9.0	186	
Po 3rd Cleaner	5		0				1	2		9.0	152	
Total	315	50	0	99	25	0		14	26			

Keep Cu/Ni and Po separate

Target ~30 um
 Target 9.5

Target ~15 um
 Target 9.0

Cl
 DE

Stage	Rougher/Scavenger	Po Rougher	Cu/Ni 1st/2nd Cleaner	Po 1st & 2nd Cl
Flotation Cell	2 kg float cell	2 kg float cell	500g/250g float cell	250g float cell
Speed: r.p.m.	1800	1800	1500/1200	1200

Metallurgical Balance

Product	Weight		Assays, %								% Distribution						
	g	%	Cu	Ni	S	Other	Cp	Pn	Po	Ga	Cu	Ni	S	Cp	Pn	Po	Ga
F39 Cu/Ni 1st Cleaner Conc-1	63.9	3.4	19.9	8.4	33.9	37.8	57.7	23.1	15.8	3.4	69.2	24.3	7.1	69.2	29.0	1.4	0.2
F39 Cu/Ni 1st Cleaner Conc-2	20.0	1.1	11.9	14.1	33.3	40.7	34.5	38.9	21.8	4.8	13.0	12.8	2.2	13.0	15.3	0.6	0.1
F39 Cu/Ni 1st Cleaner Scav Conc	21.9	1.2	4.54	13.4	34.1	48.0	13.2	36.6	45.2	5.0	5.4	13.3	2.5	5.4	15.7	1.4	0.1
F39 Po 3rd Cleaner Conc	20.7	1.1	1.84	7.64	36.8	53.7	5.33	20.2	73.4	1.0	2.1	7.2	2.5	2.1	8.2	2.2	0.0
F39 Po 3rd Cleaner Tails	20.3	1.1	0.66	2.78	36.1	60.5	1.91	6.52	86.4	5.1	0.7	2.6	2.4	0.7	2.6	2.5	0.1
F39 Po 2nd Cleaner Tails	55.8	3.0	0.42	1.81	32.9	64.9	1.22	3.89	81.0	13.9	1.3	4.6	6.0	1.3	4.3	6.5	0.7
F39 Po 1st Cleaner Tails	630.7	33.4	0.21	1.09	33.6	65.1	0.61	1.84	85.1	12.4	7.2	31.1	69.7	7.2	22.8	77.0	7.2
F39 Po Ro Scav Conc	58.3	3.1	0.11	0.71	31.9	67.3	0.32	0.82	81.9	17.0	0.3	1.9	6.1	0.3	0.9	6.8	0.9
F39 Po Ro Tails	998.3	52.8	0.01	0.05	0.44	99.5	0.04	0.06	1.1	98.8	0.8	2.4	1.4	0.8	1.2	1.5	90.7
Head (Calc.)	1889.9	100	0.97	1.17	16.1	81.8	2.82	2.69	36.9	57.6	100	100	100	100	100	100	100
Head (Dir.)			1.07	1.17	16.5	81.3	3.10	2.69	37.7	56.5							

Combined Products

Cu/Ni 1st CI Conc 1	63.9	3.4	19.9	8.40	33.9		57.7	23.1	15.8	3.4	69.2	24.3	7.1	69.2	29.0	1.4	0.2
Cu/Ni 1st CI Conc 1-2	83.9	4.4	18.0	9.76	33.8		52.2	26.9	17.2	3.7	82.2	37.1	9.3	82.2	44.3	2.1	0.3
Cu/Ni 1st CI & Scav Conc	105.8	5.6	15.2	10.5	33.8		44.1	28.9	23.0	4.0	87.6	50.3	11.8	87.6	60.0	3.5	0.4
Po 3rd CI Conc	20.7	1.1	1.84	7.64	36.8		5.33	20.2	73.4	1.0	2.1	7.2	2.5	2.1	8.2	2.2	0.0
Po 2nd CI Conc	41.0	2.2	1.26	5.23	36.5		3.64	13.4	79.9	3.1	2.8	9.7	4.9	2.8	10.8	4.7	0.1
Po 1st CI Conc	96.8	5.1	0.77	3.26	34.4		2.24	7.93	80.5	9.3	4.1	14.3	11.0	4.1	15.1	11.2	0.8
Cu/Ni 1st CI Tails & Po Ro Conc 1-3	727.5	38.5	0.29	1.38	33.7		0.83	2.65	84.5	12.0	11.3	45.4	80.7	11.3	37.8	88.2	8.0
Cu/Ni Ro Conc 1-3 & Po Ro Conc	833.3	44.1	2.18	2.54	33.7		6.32	5.98	76.7	11.0	98.9	95.7	92.4	98.9	97.9	91.7	8.4

Test: LCT-1 **Project:** 18559-01 **Date:** July 29, 2021 **Operator:** Deepak
Purpose: Based on F-19, LCT-1
Procedure: As outlined below.
Feed: 2kg SN Comp -10 mesh Freezer\SEC-11C
Grind: 20 minutes at 65% solids in 2 kg Rod Mill # 3 P₈₀ =
Regrind: 12 minutes at 50% solids in 2 kg Rod Mill for Cu/Ni R.Conc P₈₀ =
 10 minutes at 50% solids in Attrition Mill for Po R. Conc - Ceramic balls P₈₀ =

Conditions:

Stage	Reagents added, grams per tonne						Time, minutes			pH	ORP, mV
	Lime			DETA	PAX	MIBC*	Grind	Cond.	Froth		
Grind	625				5		20			8.9	151
Cu/Ni Rougher No. 1	25							1	2	9.0	158
Cu/Ni Rougher No. 2	25				5	2.5		1	2	9.0	159
Cu/Ni Rougher No. 3	15				5			1	2	9.0	174
Cu/Ni Cleaning - Cu/Ni Ro Conc 1-3											
Regrind (2kg Rod Mill)	225			25	2		12			9.3	172
Cu/Ni 1st Cleaner No.1	5							1	2	9.5	144
Cu/Ni 1st Cleaner No.2	40				3			1	3	9.5	143
Cu/Ni Cleaner Scav	30				2			1	3	9.5	148
Cu/Ni Cleaner Scalp					10				5	9.5	
Cu/Ni 2nd Cleaner									4	9.5	
Po Rougher No. 1	-				10			1	3	natural pH	195
Po Rougher No. 2	-				10	5		1	5	natural pH	210
Po Rougher No. 3	-				10	5		1	5	natural pH	223
Po Cleaning on (Po Ro Con 1-3+Cu/Ni Cleaner Scalp Conc)				Add Cu/Ni Cleaner Scalp Conc Starting Cycle B							
Regrind (Attrition Mill, Ceramic balls)	250			25	0		10				90
Po 1st Cleaner-1	0				4			1	1	9.0	90
Po 1st Cleaner-2	0				2			1	1	9.0	132
Po 1st Cleaner-3	0				2			1	1	9.0	
Po 2nd Cleaner					1			1	2	9.0	
Po 3rd Cleaner					1			1	2	9.0	
Total	615	0	0	50	67	12.5			43		

Check Malvern 35-40 um
Target pH 9.5

Check Malvern size

Target pH 9.0

Target pH 9.0

* Add as required.

Stage	Rougher/Scavenger	Po Rougher	Cu/Ni 1st/2nd Cleaner	Po 1st & 2nd Cl
Flotation Cell	2 kg float cell	2 kg float cell	500g/250g float cell	250g float cell
Speed: r.p.m.	1800	1800	1500/1200	1200

TARGET WEIGHTS	Wt. (Dry g.)	Wt. (Wet g.)	A	B	C	D	E	F
Cu/Ni 2nd Clnr Conc (exit)	160	201	158.65	165.44	162.14	153.14	160.7	169.85
Po 3rd Clnr Conc (exit)	40	60	48.15	54.5	54.2	53.5	50.57	44.21
Cu/Ni Scalp Tail (exit)	200	248	130	487.9	351.1	293.8	166.47	208.45
Po 1st Cl Tails (exit)	220	272	477.3	408.3	545.11	592	578.94	574.63
Po Ro Tail (exit)	1379	1635						
Cu/Ni Ro Conc (intermediate)	440	531						
Po Ro Conc (Intermediate)	400	484						
Cu/Ni Cl Scalp Conc (cyc F only)								123.52

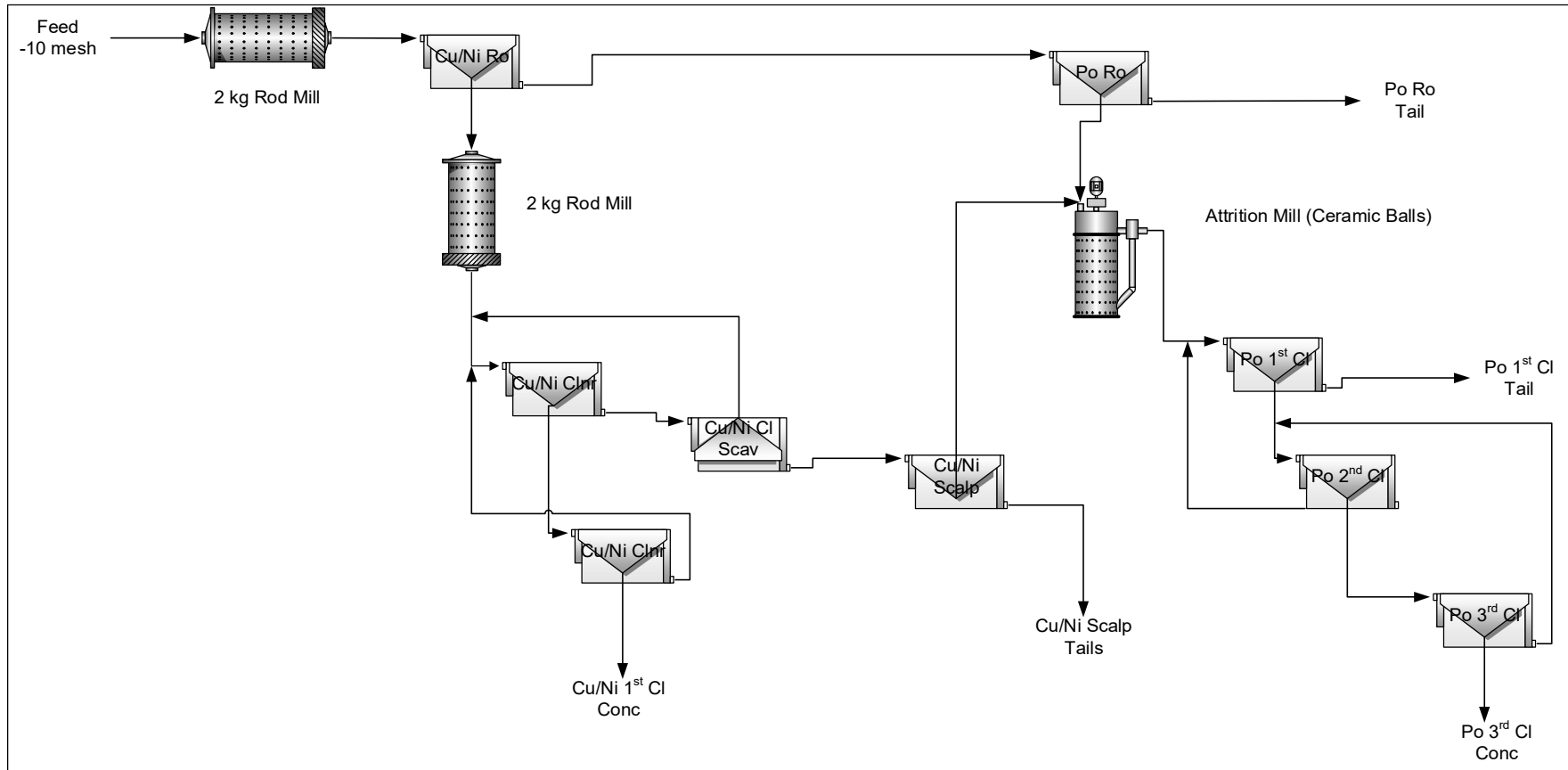

Test: LCT-1 **Project:** 18559-01 **Date:** July 29, 2021 **Operator:** Deepak/Marteen
Purpose: Based on F-19, LCT-1
Procedure: As outlined below.
Feed: 2kg SN Comp -10 mesh Freezer\SEC-11C
Grind: 20 minutes at 65% solids in 2 kg Rod Mill # 3 P₈₀ =
Regrind: 12 minutes at 50% solids in 2 kg Rod Mill for Cu/Ni R.Conc P₈₀ =
10 minutes at 50% solids in Attrition Mill for Po R.Conc - Ceramic balls P₈₀ =

Conditions: **Cycle A**

Stage	Reagents added, grams per tonne						Time, minutes			pH	ORP, mV	
	Lime			DETA	PAX	MIBC*	Grind	Cond.	Froth			
Grind	625				5		20				8.6	50
Cu/Ni Rougher No. 1	60							1	2		9.0	0
Cu/Ni Rougher No. 2	50				5	2.5		1	2		9.0	0
Cu/Ni Rougher No. 3	20				5	5		1	2		9.0	50
Cu/Ni Rougher No. 4	25				2.5	5		1	2		9.0	50
Cu/Ni Rougher No. 5	20				2.5	7.5		1	2		9.0	50
Cu/Ni Cleaning - Cu/Ni Ro Conc 1-3												
Regrind (2kg Rod Mill)	225			25	2		12				9.0	141
Cu/Ni 1st Cleaner No.1	30							1	2		9.5	113
Cu/Ni 1st Cleaner No.2	15				3			1	3		9.5	155
Cu/Ni Cleaner Scav	25				2			1	3		9.5	135
Cu/Ni Cleaner Scalp	30				10				5		9.5	118
Cu/Ni 2nd Cleaner	30				0				4		9.5	138
Po Rougher No. 1	-				10			1	3		8.5	50
Po Rougher No. 2	-				10	5		1	5		8.2	50
Po Rougher No. 3	-				10	5		1	5		8.1	50
Po Cleaning on (Po Ro Con 1-3+Cu/Ni Cleaner Scalp Conc) Add Cu/Ni Cleaner Scalp Conc Starting Cycle B												
Regrind (Attrition Mill, Ceramic balls)	250			25	0		10				9.0	90
Po 1st Cleaner-1	0				4			1	1		9.0	90
Po 1st Cleaner-2	10				2			1	1		9.0	156
Po 1st Cleaner-3	20				2			1	1		9.0	171
Po 2nd Cleaner	10				1			1	2		9.0	164
Po 3rd Cleaner	15				1			1	2		9.0	161
Total	835	0	0	50	72	30			47			

Check Malvern 35-40 um
Target pH 9.5

Check Malvern size

Target pH 9.0

Target pH 9.0

* Add as required.

Stage	Rougher/Scavenger	Po Rougher	Cu/Ni 1st/2nd Cleaner	Po 1st & 2nd Cl
Flotation Cell	2 kg float cell	2 kg float cell	500g/250g float cell	250g float cell
Speed: r.p.m.	1800	1800	1500/1200	1200

Test: LCT-1 **Project:** 18559-01 **Date:** July 29, 2021 **Operator:** Deepak/Marteen
Purpose: Based on F-19, LCT-1
Procedure: As outlined below.
Feed: 2kg SN Comp -10 mesh Freezer\SEC-11C
Grind: 20 minutes at 65% solids in 2 kg Rod Mill # 3 P₈₀ =
Regrind: 12 minutes at 50% solids in 2 kg Rod Mill for Cu/Ni R.Conc P₈₀ =
 10 minutes at 50% solids in Attrition Mill for Po R.Conc - Ceramic balls P₈₀ =

Conditions: **Cycle B**

Stage	Reagents added, grams per tonne						Time, minutes			pH	ORP, mV
	Lime			DETA	PAX	W31	Grind	Cond.	Froth		
Grind	625				5		20				
Cu/Ni Rougher No. 1	0				5	5		1	2	9.1	0
Cu/Ni Rougher No. 2	20				5	5		1	2	9.0	0
Cu/Ni Rougher No. 3	30				5	5		1	2	9.0	50
Cu/Ni Cleaning - Cu/Ni Ro Conc 1-3											
Regrind (2kg Rod Mill)	225			25	2		12			9.0	141
Cu/Ni 1st Cleaner No.1	30							1	2	9.5	113
Cu/Ni 1st Cleaner No.2	15				3			1	3	9.5	155
Cu/Ni Cleaner Scav	25				2			1	3	9.5	135
Cu/Ni Cleaner Scalp	30				10				5	9.5	118
Cu/Ni 2nd Cleaner	30				2				4+2	9.5	138
Po Rougher No. 1	-				10			1	3	8.3	25
Po Rougher No. 2	-				10	5		1	5	8.2	50
Po Rougher No. 3	-				10	5		1	5	8.0	50
Po Cleaning on (Po Ro Con 1-3+Cu/Ni Cleaner Scalp Conc)				Add Cu/Ni Cleaner Scalp Conc Starting Cycle B							
Regrind (Attrition Mill, Ceramic balls)	250			25	0		10			9.0	90
Po 1st Cleaner-1	0				4			1	1	9.0	90
Po 1st Cleaner-2	10				2			1	1	9.0	156
Po 1st Cleaner-3	20				2			1	1	9.0	171
Po 2nd Cleaner	5				0			1	2	9.0	83
Po 3rd Cleaner	5				0			1	2	9.0	146
Total	695	0	0	50	72	25			39		

Check Malvern 35-40 um
Target pH 9.5

Check Malvern size

Target pH 9.0

Target pH 9.0

* Add as required.

Stage	Rougher/Scavenger	Po Rougher	Cu/Ni 1st/2nd Cleaner	Po 1st & 2nd Cl
Flotation Cell	2 kg float cell	2 kg float cell	500g/250g float cell	250g float cell
Speed: r.p.m.	1800	1800	1500/1200	1200

Test: LCT-1 **Project:** 18559-01 **Date:** July 29, 2021 **Operator:** Deepak/Marteen
Purpose: Based on F-19, LCT-1
Procedure: As outlined below.
Feed: 2kg SN Comp -10 mesh Freezer\SEC-11C
Grind: 20 minutes at 65% solids in 2 kg Rod Mill # 3 P₈₀ =
Regrind: 20 minutes at 50% solids in 2 kg Rod Mill for Cu/Ni R.Conc P₈₀ =
20 minutes at 50% solids in Attrition Mill for Po R.Conc - Ceramic balls 4.5mm P₈₀ =

Conditions: Cycle C

Stage	Reagents added, grams per tonne						Time, minutes			pH	ORP, mV
	Lime			DETA	PAX	W31	Grind	Cond.	Froth		
Grind	625				5		20				
Cu/Ni Rougher No. 1	25				5	5		1	2	9.1	0
Cu/Ni Rougher No. 2	20				5	5		1	2	9.0	0
Cu/Ni Rougher No. 3	40				5	5		1	2	9.0	50
Cu/Ni Rougher No. 4	20				2.5			1	1	9.0	50
Cu/Ni Cleaning - Cu/Ni Ro Conc 1-3											
Regrind (2kg Rod Mill)	225			25	2		12			8.9	144
Cu/Ni 1st Cleaner No.1	50							1	2	9.5	78
Cu/Ni 1st Cleaner No.2	30				3			1	3	9.5	137
Cu/Ni Cleaner Scav	40				2			1	3	9.5	135
Cu/Ni Cleaner Scalp	40				10				5	9.5	134
Cu/Ni 2nd Cleaner	20				2				4	9.5	121
Po Rougher No. 1	-				10	5		1	3	8.4	50
Po Rougher No. 2	-				10	0		1	5	8.2	50
Po Cleaning on (Po Ro Con 1-3+Cu/Ni Cleaner Scalp Conc)				Add Cu/Ni Cleaner Scalp Conc Starting Cycle B							
Regrind (Attrition Mill, Ceramic balls)	250			25	0		10			9.8	40
Po 1st Cleaner-1	0				4			1	1	9.8	40
Po 1st Cleaner-2	0				0			1	1	9.0	160
Po 1st Cleaner-3	5				0			1	1	9.0	164
Po 2nd Cleaner	5				0			1	2	9.0	146
Po 3rd Cleaner	5				0			1	2	9.0	164
Total	775	0	0	50	60.5	20			39		

Check Malvern 35-40 um
Target pH 9.5

Check Malvern size

Target pH 9.0

Target pH 9.0

* Add as required.

Stage	Rougher/Scavenger	Po Rougher	Cu/Ni 1st/2nd Cleaner	Po 1st & 2nd Cl
Flotation Cell	2 kg float cell	2 kg float cell	500g/250g float cell	250g float cell
Speed: r.p.m.	1800	1800	1500/1200	1200

Test: LCT-1 **Project:** 18559-01 **Date:** July 29, 2021 **Operator:** Deepak/Marteen
Purpose: Based on F-19, LCT-1
Procedure: As outlined below.
Feed: 2kg SN Comp -10 mesh Freezer\SEC-11C
Grind: 20 minutes at 65% solids in 2 kg Rod Mill # 3 P₈₀ =
Regrind: 20 minutes at 50% solids in 2 kg Rod Mill for Cu/Ni R.Conc P₈₀ =
20 minutes at 50% solids in Attrition Mill for Po R. Conc - Ceramic balls 4,5mm P₈₀ =

Conditions: **Cycle D**

Stage	Reagents added, grams per tonne						Time, minutes			pH	ORP, mV	
	Lime			DETA	PAX	MIBC*	Grind	Cond.	Froth			
Grind	625				5		20				8.8	
Cu/Ni Rougher No. 1	25				5			1	2		9.0	25
Cu/Ni Rougher No. 2	20				5	2.5		1	2		9.0	50
Cu/Ni Rougher No. 3	40				5			1	2		9.0	50
Cu/Ni Cleaning - Cu/Ni Ro Conc 1-3												
Regrind (2kg Rod Mill)	225			25	2		20				8.7	181
Cu/Ni 1st Cleaner No.1	15							1	2		9.5	161
Cu/Ni 1st Cleaner No.2	30				5	2.5		1	3		9.5	136
Cu/Ni Cleaner Scav	55				2			1	3		9.5	137
Cu/Ni Cleaner Scalp	25				10				5		9.5	138
Cu/Ni 2nd Cleaner	10				2+2				4+2		9.5	138
Po Rougher No. 1	-				10			1	3		8.5	50
Po Rougher No. 2	-				10	5		1	5		8.2	50
Po Rougher No. 3	-				10	5		1	5		8.0	50
Po Cleaning on (Po Ro Con 1-3+Cu/Ni Cleaner Scalp Conc)				Add Cu/Ni Cleaner Scalp Conc Starting Cycle B								
Regrind (Attrition Mill, Ceramic balls)	250			25	0		20				9.0	159
Po 1st Cleaner-1	0				4			1	1		9.8	159
Po 1st Cleaner-2	5				0			1	1		9.0	160
Po 1st Cleaner-3	5				0			1	1		9.0	134
Po 2nd Cleaner	5				0			1	2		9.0	158
Po 3rd Cleaner	5				0			1	2		9.0	151
Total	715	0	0	50	68	15			39			

Check Malvern 35-40 um
Target pH 9.5

Check Malvern size

Target pH 9.0

Target pH 9.0

* Add as required.

Stage	Rougher/Scavenger	Po Rougher	Cu/Ni 1st/2nd Cleaner	Po 1st & 2nd Cl
Flotation Cell	2 kg float cell	2 kg float cell	500g/250g float cell	250g float cell
Speed: r.p.m.	1800	1800	1500/1200	1200

Test: LCT-1 **Project:** 18559-01 **Date:** July 29, 2021 **Operator:** Deepak/Marteen
Purpose: Based on F-19, LCT-1
Procedure: As outlined below.
Feed: 2kg SN Comp -10 mesh Freezer\SEC-11C
Grind: 20 minutes at 65% solids in 2 kg Rod Mill # 3 P₈₀ =
Regrind: 12 minutes at 50% solids in 2 kg Rod Mill for Cu/Ni R.Conc P₈₀ =
10 minutes at 50% solids in Attrition Mill for Po R.Conc - Ceramic balls P₈₀ =

Conditions: **Cycle E**

Stage	Reagents added, grams per tonne						Time, minutes			pH	ORP, mV
	Lime			DETA	PAX	MIBC*	Grind	Cond.	Froth		
Grind	625				5		20			9.0	
Cu/Ni Rougher No. 1					5	5		1	2	9.0	25
Cu/Ni Rougher No. 2	25				5	5		1	2	9.0	50
Cu/Ni Rougher No. 3	20				5	5		1	2	9.0	50
Cu/Ni Cleaning - Cu/Ni Ro Conc 1-3											
Regrind (2kg Rod Mill)	300			25	2		20			9.3	254
Cu/Ni 1st Cleaner No.1	20							1	2	9.5	223
Cu/Ni 1st Cleaner No.2	35				5	2.5		1	3+1	9.5	140
Cu/Ni Cleaner Scav	35				2			1	3	9.5	143
Cu/Ni Cleaner Scalp	30				10				5	9.5	142
Cu/Ni 2nd Cleaner	15				2				4	9.5	138
Po Rougher No. 1	-				10	5		1	3	8.5	50
Po Rougher No. 2	-				10	5		1	5	8.2	50
Po Rougher No. 3	-				10	2.5		1	5	7.9	50
Po Cleaning on (Po Ro Con 1-3+Cu/Ni Cleaner Scalp Conc)				Add Cu/Ni Cleaner Scalp Conc Starting Cycle B							
Regrind (Attrition Mill, Ceramic balls)	250			25	0		10			9.5	158
Po 1st Cleaner-1	0				4			1	1	9.8	158
Po 1st Cleaner-2	0				0			1	1	9.0	169
Po 1st Cleaner-3	15				0			1	1	9.0	161
Po 2nd Cleaner	5				0			1	2	9.0	105
Po 3rd Cleaner	5				0			1	2	9.0	142
Total	755	0	0	50	70	30			40		

Check Malvern 35-40 um
Target pH 9.5

Check Malvern size

Target pH 9.0

Target pH 9.0

* Add as required.

Stage	Rougher/Scavenger	Po Rougher	Cu/Ni 1st/2nd Cleaner	Po 1st & 2nd Cl
Flotation Cell	2 kg float cell	2 kg float cell	500g/250g float cell	250g float cell
Speed: r.p.m.	1800	1800	1500/1200	1200

Test: LCT-1 **Project:** 18559-01 **Date:** July 29, 2021 **Operator:** Deepak/Marteen
Purpose: Based on F-19, LCT-1
Procedure: As outlined below.
Feed: 2kg SN Comp -10 mesh Freezer\SEC-11C
Grind: 20 minutes at 65% solids in 2 kg Rod Mill # 3 P₈₀ =
Regrind: 12 minutes at 50% solids in 2 kg Rod Mill for Cu/Ni R.Conc P₈₀ =
10 minutes at 50% solids in Attrition Mill for Po R.Conc - Ceramic balls P₈₀ =

Conditions: **Cycle F**

Stage	Reagents added, grams per tonne						Time, minutes			pH	ORP, mV
	Lime			DETA	PAX	MIBC*	Grind	Cond.	Froth		
Grind	625				5		20				
Cu/Ni Rougher No. 1					5	5		1	2	9.0	25
Cu/Ni Rougher No. 2	20				5	5		1	2	9.0	50
Cu/Ni Rougher No. 3	20				5	5		1	2	9.0	50
Cu/Ni Cleaning - Cu/Ni Ro Conc 1-3											
Regrind (2kg Rod Mill)	300			25	2		20			9.3	162
Cu/Ni 1st Cleaner No.1	20							1	2	9.5	154
Cu/Ni 1st Cleaner No.2	40				5	2.5		1	3+1	9.5	134
Cu/Ni Cleaner Scav	15				2			1	3	9.5	141
Cu/Ni Cleaner Scalp	40				10				5	9.5	136
Cu/Ni 2nd Cleaner	15				2				4	9.5	128
Po Rougher No. 1	-				10	5		1	3	8.5	50
Po Rougher No. 2	-				10	5		1	5	8.2	50
Po Rougher No. 3	-				10	2.5		1	5	8.0	50
Po Cleaning on (Po Ro Con 1-3+Cu/Ni Cleaner Scalp Conc)				Add Cu/Ni Cleaner Scalp Conc Starting Cycle B							
Regrind (Attrition Mill, Ceramic balls)	250			25	0		10			9.3	128
Po 1st Cleaner-1	0				4			1	1	9.8	128
Po 1st Cleaner-2	0				0			1	1	9.0	167
Po 1st Cleaner-3	5				0			1	1	9.0	175
Po 2nd Cleaner	10				0			1	2	9.0	169
Po 3rd Cleaner	5				0			1	2	9.0	152
Total	740	0	0	50	70	30			40		

Check Malvern 35-40 um
Target pH 9.5

Check Malvern size

Target pH 9.0

Target pH 9.0

* Add as required.

Stage	Rougher/Scavenger	Po Rougher	Cu/Ni 1st/2nd Cleaner	Po 1st & 2nd Cl
Flotation Cell	2 kg float cell	2 kg float cell	500g/250g float cell	250g float cell
Speed: r.p.m.	1800	1800	1500/1200	1200

Metallurgical Projection (B-F)

Product	Wt		Assays, %						% Distribution					
	g	%	Cu	Ni	S	Cp	Pn	Po	Cu	Ni	S	Cp	Pn	Po
Cu/Ni 2nd CI Conc	803.4	6.7	14.2	9.43	34.4	41.2	25.8	29.9	94.3	55.3	14.4	94.3	65.8	5.5
Cu/Ni Scalp Tail	1411.1	11.7	0.16	1.07	32.8	0.47	1.80	83.3	1.9	11.0	24.2	1.9	8.1	26.8
Po 3rd CI Conc	201.2	1.7	0.78	5.54	37.1	2.27	14.2	82.1	1.3	8.1	3.9	1.3	9.1	3.8
Comb. Cu/Ni Conc	1004.6	8.3	11.5	8.65	35.0	33.4	23.5	40.3	95.6	63.4	18.3	95.6	74.9	9.2
Po 1st CI Tails	2682	22.2	0.09	1.02	33.6	0.26	1.62	85.7	2.0	19.9	47.0	2.0	13.8	52.3
Po Rougher Tail	6976	57.8	0.01	0.11	2.90	0.03	0.14	7.37	0.6	5.8	10.5	0.6	3.2	11.7
Head (Calc.)	12074	100	1.00	1.14	15.9	2.91	2.61	36.4	100	100	100	100	100	100
Head (Dir.)			1.07	1.17	16.5	3.10	2.69	37.7						

Metallurgical Balance

Product	Weight		Assays, %						% Distribution					
	g	%	Cu	Ni	S	Cp	Pn	Po	Cu	Ni	S	Cp	Pn	Po
LCT-1 Cu/Ni 2nd CI Conc - A	132.3	1.1	13.1	8.99	34.5	38.0	24.5	34.1	14.3	8.3	2.4	14.3	9.8	1.0
LCT-1 Cu/Ni 2nd CI Conc - B	136.4	1.1	14.2	8.93	34.1	41.2	24.4	30.3	15.9	8.5	2.4	15.9	10.1	0.9
LCT-1 Cu/Ni 2nd CI Conc - C	139.0	1.2	13.7	10.1	34.3	39.7	27.6	29.3	15.7	9.8	2.5	15.7	11.7	0.9
LCT-1 Cu/Ni 2nd CI Conc - D	125.3	1.0	15.2	9.80	35.3	44.1	26.8	28.6	15.7	8.6	2.3	15.7	10.2	0.8
LCT-1 Cu/Ni 2nd CI Conc - E	131.1	1.1	13.1	9.12	34.2	38.0	24.9	33.0	14.1	8.4	2.3	14.1	9.9	1.0
LCT-1 Cu/Ni 2nd CI Conc - F	137.6	1.1	14.9	9.20	34.3	43.2	25.2	28.3	16.9	8.9	2.4	16.9	10.5	0.9
LCT-1 Cu/Ni 2nd CI Tails-F	33.8	0.3	0.75	3.05	33.8	2.17	7.36	79.5	0.2	0.7	0.6	0.2	0.8	0.6
LCT-1 Cu/Ni CI Scav Conc-F	28.7	0.2	3.74	7.54	34.8	10.8	20.1	63.3	0.9	1.5	0.5	0.9	1.7	0.4
LCT-1 Cu/Ni CI Scalp Conc-F	92.2	0.8	0.93	3.34	35.3	2.70	8.13	82.3	0.7	2.2	1.7	0.7	2.3	1.7
LCT-1 Cu/Ni CI Scalp Tails- A	89.5	0.7	0.13	1.04	27.3	0.38	1.91	68.9	0.1	0.7	1.3	0.1	0.5	1.4
LCT-1 Cu/Ni CI Scalp Tails- B	383.8	3.2	0.12	1.10	33.1	0.35	1.88	84.0	0.4	3.0	6.6	0.4	2.2	7.3
LCT-1 Cu/Ni CI Scalp Tails- C	271.3	2.2	0.13	0.98	32.2	0.38	1.57	81.9	0.3	1.9	4.5	0.3	1.3	5.0
LCT-1 Cu/Ni CI Scalp Tails- D	224.0	1.9	0.19	1.12	34.1	0.55	1.90	86.4	0.4	1.8	4.0	0.4	1.3	4.4
LCT-1 Cu/Ni CI Scalp Tails- E	134.9	1.1	0.24	1.10	32.1	0.70	1.92	81.1	0.3	1.0	2.2	0.3	0.8	2.5
LCT-1 Cu/Ni CI Scalp Tails-F	161.9	1.3	0.21	1.04	32.1	0.61	1.75	81.3	0.3	1.2	2.7	0.3	0.9	3.0
LCT-1 Po 3rd CI Conc-A	17.4	0.1	0.79	6.93	36.5	2.29	18.2	77.1	0.1	0.8	0.3	0.1	1.0	0.3
LCT-1 Po 3rd CI Conc-B	35.8	0.3	0.27	2.98	36.7	0.78	7.04	88.6	0.1	0.7	0.7	0.1	0.8	0.7
LCT-1 Po 3rd CI Conc-C	42.5	0.4	0.45	4.45	37.2	1.30	11.2	85.9	0.2	1.3	0.8	0.2	1.4	0.8
LCT-1 Po 3rd CI Conc-D	36.0	0.3	0.93	6.89	37.7	2.70	18.0	80.0	0.3	1.7	0.7	0.3	2.0	0.7
LCT-1 Po 3rd CI Conc-E	27.4	0.2	0.90	5.75	37.0	2.61	14.8	81.0	0.2	1.1	0.5	0.2	1.2	0.5
LCT-1 Po 3rd CI Conc-F	26.0	0.2	1.70	8.76	36.7	4.93	23.3	70.8	0.4	1.6	0.5	0.4	1.8	0.4
LCT-1 Po 3rd CI Tails-F	32.2	0.3	0.48	3.33	36.8	1.39	8.03	87.4	0.1	0.8	0.6	0.1	0.8	0.6
LCT-1 Po 2nd CI Tails-F	119.9	1.0	0.26	2.21	37.2	0.75	4.86	91.8	0.3	1.9	2.3	0.3	1.8	2.5
LCT-1 Po 1st CI Tails-A	383.2	3.2	0.06	0.84	33.5	0.17	1.13	85.9	0.2	2.3	6.7	0.2	1.3	7.5
LCT-1 Po 1st CI Tails-B	333.0	2.8	0.04	0.85	32.4	0.10	1.20	83.0	0.1	2.0	5.6	0.1	1.2	6.3
LCT-1 Po 1st CI Tails-C	477.5	4.0	0.07	0.94	33.5	0.20	1.41	85.6	0.3	3.1	8.3	0.3	2.0	9.3
LCT-1 Po 1st CI Tails-D	476.6	3.9	0.08	0.97	34.1	0.24	1.48	87.1	0.3	3.2	8.4	0.3	2.1	9.4
LCT-1 Po 1st CI Tails-E	462.3	3.8	0.13	1.17	33.5	0.38	2.06	84.9	0.5	3.8	8.0	0.5	2.9	8.9
LCT-1 Po 1st CI Tails-F	485.4	4.0	0.12	1.10	34.2	0.35	1.84	86.9	0.5	3.7	8.6	0.5	2.7	9.6
LCT-1 Po Ro Tails-A	1096	9.1	0.01	0.10	1.38	0.03	0.16	3.42	0.1	0.8	0.8	0.1	0.5	0.9
LCT-1 Po Ro Tails-B	1084	9.0	<0.01	0.09	1.83	0.01	0.12	4.64	0.0	0.7	1.0	0.0	0.4	1.1
LCT-1 Po Ro Tails-C	1112	9.2	0.01	0.10	1.91	0.04	0.14	4.80	0.1	0.8	1.1	0.1	0.5	1.2
LCT-1 Po Ro Tails-D	1194	9.9	0.01	0.13	3.15	0.03	0.18	7.99	0.1	1.1	1.9	0.1	0.7	2.2
LCT-1 Po Ro Tails-E	1230	10.2	0.01	0.13	4.02	0.04	0.15	10.3	0.1	1.1	2.6	0.1	0.6	2.9
LCT-1 Po Ro Tails-F	1194	9.9	<0.01	0.11	3.37	0.01	0.12	8.64	0.0	0.9	2.1	0.0	0.4	2.3
Head (Calc.)	12087	100	1.01	1.18	16.0	2.91	2.73	36.5	100	100	100	100	100	100
Head (Dir.)			1.07	1.17	16.5	3.10	2.69	37.7						

Use 0.005 for <0.01

Combined Products

Product	Weight		Assays, %						% Distribution					
	g	%	Cu	Ni	S	Cp	Pn	Po	Cu	Ni	S	Cp	Pn	Po
Cu/Ni 2nd CI Conc A-F		6.9	13.5	9.10	34.4	39.1	24.8	32.6	92.8	53.3	14.9	92.8	62.9	6.2
Cu/Ni Scalp Tail A-F		10.5	0.16	1.07	32.4	0.46	1.81	82.3	1.7	9.5	21.3	1.7	6.9	23.6
Cu/Ni 2nd CI Tails F		0.3	0.75	3.05	33.8	2.17	7.36	79.5	0.2	0.7	0.6	0.2	0.8	0.6
Cu/Ni CI Scav Conc F		0.2	3.74	7.54	34.8	10.8	20.1	63.3	0.9	1.5	0.5	0.9	1.7	0.4
Cu/Ni CI Scalp Conc F		0.8	0.93	3.34	35.3	2.70	8.13	82.3	0.7	2.2	1.7	0.7	2.3	1.7
Po 3rd CI Conc A-F		1.5	0.78	5.67	37.0	2.27	14.6	81.6	1.2	7.4	3.6	1.2	8.2	3.4
Po 1st CI Tails A-F		21.7	0.09	0.99	33.6	0.25	1.55	85.7	1.8	18.2	45.6	1.8	12.3	50.9
Po 3rd CI Tails F		0.3	0.48	3.33	36.8	1.39	8.03	87.4	0.1	0.8	0.6	0.1	0.8	0.6
Po 2nd CI Tails F		1.0	0.26	2.21	37.2	0.75	4.86	91.8	0.3	1.9	2.3	0.3	1.8	2.5
Po Ro Tail A-F		57.2	0.01	0.11	2.66	0.03	0.15	6.74	0.6	5.4	9.5	0.6	3.1	10.6
Head (calc)		100	1.00	1.18	16.01	2.91	2.74	36.58	100	101	101	100	101	101

Stability

	Weight		Assays,%		
	g	%	Cu	Ni	S
Total <u>In</u> All Cycles	12087	100	1.01	1.18	15.96
Average <u>In</u> Per Cycle	2014	16.7			

Total Products Out Per Cycle	Weight		Units out as a % of Units in/Cycle		
	g	Wt %	Cu	Ni	S
Cycle A	1719	85.3	88.5	77.2	68.4
Cycle B	1973	97.9	99.2	89.6	97.8
Cycle C	2042	101.4	99.1	101.8	103.3
Cycle D	2056	102.0	100.4	98.7	104.0
Cycle E	1986	98.6	91.4	92.7	94.1
Cycle F	2005	99.5	108.3	98.0	98.0

Cycle Statistics (Least Squares)

347	357
5	6
3	8
4	7
77	129
68	145

Cycle Statistics (Least Squares)

0.1	0.2
0.2	0.5

Average of B-F	99.9	99.7	96.2	99.4
Average of C-F	100.4	99.8	97.8	99.9

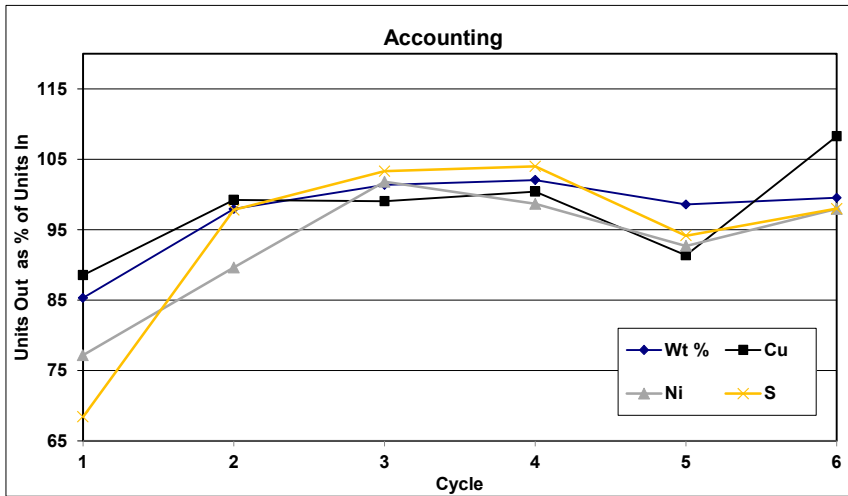

Test: LCT-2

Project: 18559-01

Date: August 4, 2021

Operator: Deepak, Marteen

Purpose:

Based on F-19

Procedure:

As outlined below.

Feed:

2kg SN Comp -10 mesh

Freezer\SEC-11C

Grind:

34 minutes at 65% solids in 2 kg Rod Mill # 3

P₈₀ =

Regrind

16 minutes at 50% solids in 2 kg Rod Mill for Cu/Ni R.Conc

P₈₀ =

12 minutes at 50% solids in Attrition Mill for Po R.Conc & Cu/Ni Scalp Conc - Ceramic balls

P₈₀ =

4.5mm

Conditions:

Global Flowsheet

Stage	Reagents added, grams per tonne				Time, minutes			pH	ORP, mV
	Lime	DETA	PAX	MIBC*	Grind	Cond.	Froth		
Grind	625		5		34			8.9	151
Cu/Ni Rougher No. 1	25		2.5			1	2	9.0	158
Cu/Ni Rougher No. 2	25		5	2.5		1	2	9.0	159
Cu/Ni Rougher No. 3	15		5			1	2	9.0	174
Cu/Ni Cleaning - Cu/Ni Ro Conc 1-3									
Regrind (2kg Rod Mill)	225	25	2		16			9.3	172
Cu/Ni 1st Cleaner No.1	5					1	2	9.5	144
Cu/Ni 1st Cleaner No.2	40		3			1	3	9.5	143
Cu/Ni Cleaner Scav	30		2			1	3	9.5	148
Cu/Ni Cleaner Scalp			10				5	9.5	
Po Rougher No. 1	-		10			1	3	natural pH	195
Po Rougher No. 2	-		10	5		1	5	natural pH	210
Po Rougher No. 3	-		10	5		1	5	natural pH	223
Po Cleaning on (Po Ro Con 1-3+Cu/Ni Cleaner Scalp Conc) Add Cu/Ni Cleaner Scalp Conc Starting Cycle B									
Regrind (Attrition Mill, Ceramic balls)	250	25	0		12				90
Po 1st Cleaner-1	0		4			1	1	9.0	90
Po 1st Cleaner-2	0		2			1	1	9.0	132
Po 1st Cleaner-3	0		2			1	1	9.0	
Po 2nd Cleaner			1			1	2	9.0	
Po 3rd Cleaner			1			1	2	9.0	
Total	615	50	69.5	12.5			39		

Check Malvern Target ~25 um
Target pH 9.5

Check Malvern size, target 20-25 um

Target pH 9.0

Target pH 9.0

* Add as required.

Stage	Rougher/Scavenger	Po Rougher	Cu/Ni 1st/2nd Cleaner	Po 1st & 2nd Cl
Flotation Cell	2 kg float cell	2 kg float cell	500g/250g float cell	250g float cell
Speed: r.p.m.	1800	1800	1500/1200	1200

TARGET WEIGHTS	Target, %	Wt. (Dry g.)	Wt. (Wet w. Paper, g)	A	B	C	D	E	F
Cu/Ni 1st Clnr Conc (exit)	8.2%	164	206	206.37	188.81	162.5	209.98	217.58	243.76
Cu/Ni Scalp Tail (exit)	7%	140	178	246.53	193.22	271.5	222.26	180.19	213.84
Po 3rd Clnr Conc (exit)	2%	40	60	31.64	57.78	47.06	38.86	32.64	37.16
Po 1st CI Tails (exit)		227	280	293.85	556.06	639.76	630.12	574.66	636.76
Po Ro Tail (exit)		1275	1513						
Cu/Ni Ro Conc (intermediate)	20%	400	484						
Po Ro Conc (Intermediate)	18-20%	380	460						
Cu/Ni CI Scalp Conc (cyc F only)									186.48

Cu/Ni Ro Conc 1-3&Po Ro Conc 1-3	37-40%
----------------------------------	--------

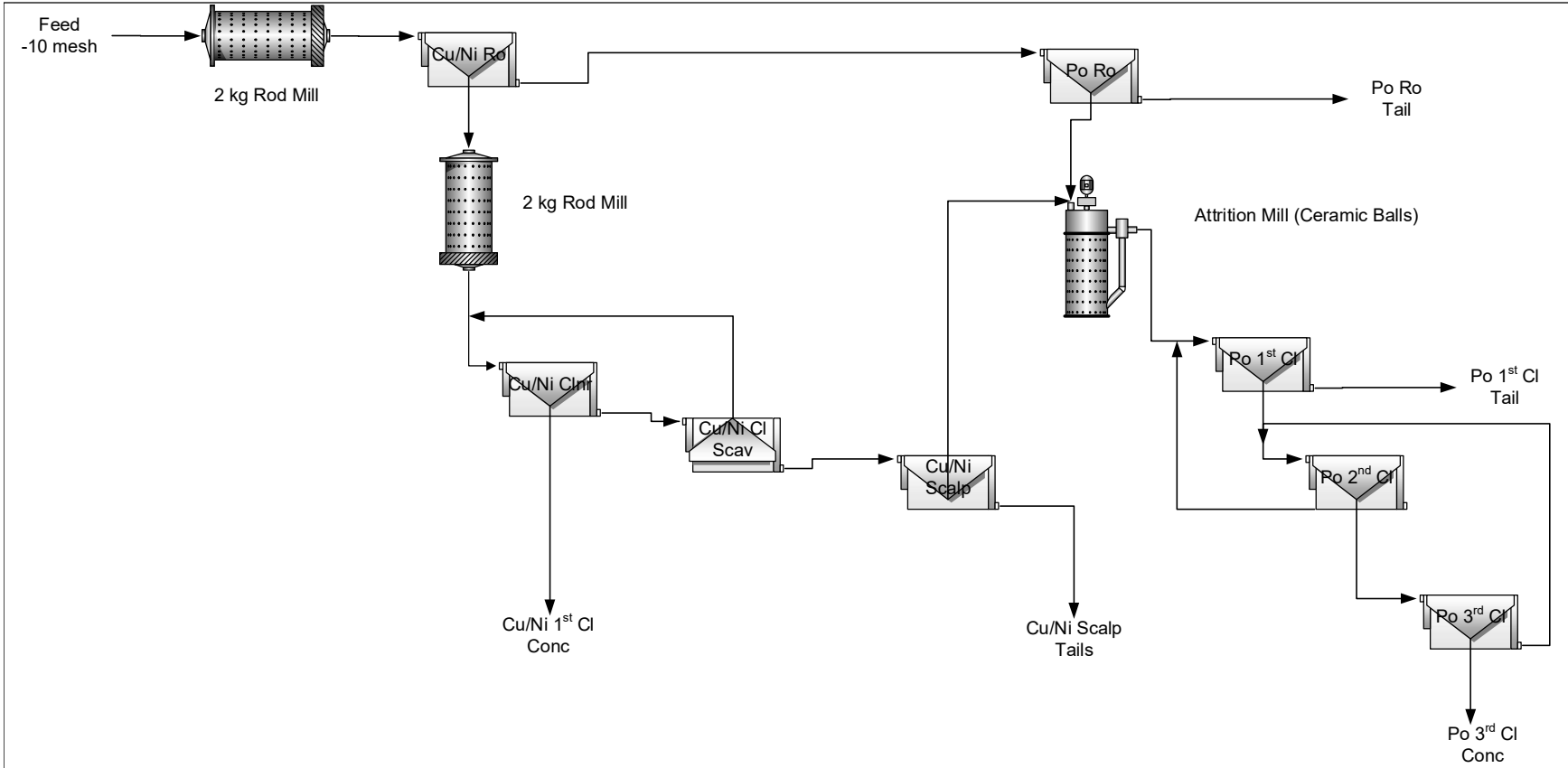

Test: LCT-2

Project: 18559-01

Date: August 4, 2021

Operator: Deepak, Marteen

Purpose:

Based on F-19

Procedure:

As outlined below.

Feed:

2kg SN Comp -10 mesh

Freezer\SEC-11C

Grind:

34 minutes at 65% solids in 2 kg Rod Mill # 3

P₈₀ =

Regrind

16 minutes at 50% solids in 2 kg Rod Mill for Cu/Ni R.Conc

P₈₀ =

12 minutes at 50% solids in Attrition Mill for Po R.Conc & Cu/Ni Scalp Conc - Ceramic balls

P₈₀ =

4.5mm

Conditions:

Cycle A

Stage	Reagents added, grams per tonne				Time, minutes			pH	ORP, mV
	Lime	DETA	PAX	MIBC*	Grind	Cond.	Froth		
Grind	625		5		34				
Cu/Ni Rougher No. 1	50		2.5	5		1	2	9.0	25
Cu/Ni Rougher No. 2	40		5	5		1	2	9.0	50
Cu/Ni Rougher No. 3	25		5	5		1	2	9.0	50
Cu/Ni Cleaning - Cu/Ni Ro Conc 1-3									
Regrind (2kg Rod Mill)	225	25	2		17.5			8.7	92
Cu/Ni 1st Cleaner No.1	50					1	2	9.5	143
Cu/Ni 1st Cleaner No.2	40		3			1	3	9.5	138
Cu/Ni Cleaner Scav	40		2			1	3	9.5	152
Cu/Ni Cleaner Scalp	45		10				5	9.5	142
Po Rougher No. 1	-		10	5		1	3	8.0	75
Po Rougher No. 2	-		10	5		1	3	8.0	75
Po Cleaning on (Po Ro Con 1-3+Cu/Ni Cleaner Scalp Conc) Add Cu/Ni Cleaner Scalp Conc Starting Cycle B									
Regrind (Attrition Mill, Ceramic balls)	250	25	0		12			10.4	63
Po 1st Cleaner-1	0		4			1	1	10.4	78
Po 1st Cleaner-2	0		2			1	1	9.2	173
Po 1st Cleaner-3	10		2			1	1	9.0	177
Po 2nd Cleaner	10		1			1	2	9.0	167
Po 3rd Cleaner	10		1			1	2	9.0	182
Total	795	50	59.5	25			32		

Check Malvern Target ~25 um
Target pH 9.5

Check Malvern size, target 20-25 um

Target pH 9.0

Target pH 9.0

* Add as required.

Stage	Rougher/Scavenger	Po Rougher	Cu/Ni 1st/2nd Cleaner	Po 1st & 2nd Cl
Flotation Cell	2 kg float cell	2 kg float cell	500g/250g float cell	250g float cell
Speed: r.p.m.	1800	1800	1500/1200	1200

Test: LCT-2

Project: 18559-01

Date: August 4, 2021

Operator: Deepak, Marteen

Purpose:

Based on F-19

Procedure:

As outlined below.

Feed:

2kg SN Comp -10 mesh

Freezer\SEC-11C

Grind:

34 minutes at 65% solids in 2 kg Rod Mill # 3

P₈₀ =

Regrind

16 minutes at 50% solids in 2 kg Rod Mill for Cu/Ni R.Conc

P₈₀ =

12 minutes at 50% solids in Attrition Mill for Po R.Conc & Cu/Ni Scalp Conc - Ceramic balls

P₈₀ =

4.5mm

Conditions:

Cycle B

Stage	Reagents added, grams per tonne				Time, minutes			pH	ORP, mV
	Lime	DETA	PAX	MIBC*	Grind	Cond.	Froth		
Grind	625		5		34				
Cu/Ni Rougher No. 1	35		0	5		1	2	9.0	50
Cu/Ni Rougher No. 2	25		5	5		1	2	9.0	50
Cu/Ni Rougher No. 3	25		5	0		1	2	9.0	50
Cu/Ni Rougher No. 4	25		2.5	0		1	2	9.0	50
Cu/Ni Cleaning - Cu/Ni Ro Conc 1-3									
Regrind (2kg Rod Mill)	225	25	2		20			9.0	169
Cu/Ni 1st Cleaner No.1	45					1	2	9.5	126
Cu/Ni 1st Cleaner No.2	40		3			1	3	9.5	143
Cu/Ni Cleaner Scav	45		2			1	3	9.5	144
Cu/Ni Cleaner Scalp	40		10				5	9.5	142
Po Rougher No. 1	-		10			1	3	8.2	25
Po Rougher No. 2	-		10	5		1	5	8.1	50
Po Rougher No. 3	-		10	5		1	5	8.0	50
Po Cleaning on (Po Ro Con 1-3+Cu/Ni Cleaner Scalp Conc) Add Cu/Ni Cleaner Scalp Conc Starting Cycle B									
Regrind (Attrition Mill, Ceramic balls)	200	25	0		20			9.0	168
Po 1st Cleaner-1	0		4			1	1	9.0	168
Po 1st Cleaner-2	5		2			1	1	9.0	173
Po 1st Cleaner-3	25		2			1	1	9.0	173
Po 2nd Cleaner	10		1			1	2	9.0	158
Po 3rd Cleaner	10		1			1	2	9.0	162
Total	755	50	69.5	20			41		

Check Malvern Target ~25 um

Target pH 9.5

Check Malvern size, target 20-25 um

Target pH 9.0

Target pH 9.0

* Add as required.

Stage	Rougher/Scavenger	Po Rougher	Cu/Ni 1st/2nd Cleaner	Po 1st & 2nd Cl
Flotation Cell	2 kg float cell	2 kg float cell	500g/250g float cell	250g float cell
Speed: r.p.m.	1800	1800	1500/1200	1200

Test: LCT-2

Project: 18559-01

Date: August 4, 2021

Operator: Deepak, Marteen

Purpose:

Based on F-19

Procedure:

As outlined below.

Feed:

2kg SN Comp -10 mesh

Freezer\SEC-11C

Grind:

34 minutes at 65% solids in 2 kg Rod Mill # 3

P₈₀ =

Regrind

16 minutes at 50% solids in 2 kg Rod Mill for Cu/Ni R.Conc

P₈₀ =

12 minutes at 50% solids in Attrition Mill for Po R.Conc & Cu/Ni Scalp Conc - Ceramic balls

P₈₀ =

4.5mm

Conditions:

Cycle C

Stage	Reagents added, grams per tonne				Time, minutes			pH	ORP, mV
	Lime	DETA	PAX	MIBC*	Grind	Cond.	Froth		
Grind	625		5		34				
Cu/Ni Rougher No. 1	35		2.5	5		1	2	9.0	25
Cu/Ni Rougher No. 2	25		5	5		1	2	9.0	25
Cu/Ni Rougher No. 3	25		5	2.5		1	2	9.0	50
Cu/Ni Rougher No. 4	25		2.5	2.5		1	1	9.0	50
Cu/Ni Cleaning - Cu/Ni Ro Conc 1-3									
Regrind (2kg Rod Mill)	250	25	2		22.5			8.6	183
Cu/Ni 1st Cleaner No.1	80					1	2	9.5	147
Cu/Ni 1st Cleaner No.2	35		3			1	3	9.5	136
Cu/Ni 1st Cleaner No.3	65		2			1	2	9.5	128
Cu/Ni Cleaner Scav	55		2	2.5		1	3	9.5	122
Cu/Ni Cleaner Scalp	25		10	2.5			5	9.5	139
Po Rougher No. 1	-		10			1	3	8.2	50
Po Rougher No. 2	-		10	5		1	5	8.0	50
Po Rougher No. 3	-		10	5		1	5	8.0	50
Po Cleaning on (Po Ro Con 1-3+Cu/Ni Cleaner Scalp Conc) Add Cu/Ni Cleaner Scalp Conc Starting Cycle B									
Regrind (Attrition Mill, Ceramic balls)	200	25	0		30			8.8	177
Po 1st Cleaner-1	5		4			1	1	9.0	178
Po 1st Cleaner-2	15		2			1	1	9.0	160
Po 1st Cleaner-3	20		2			1	1	9.0	162
Po 2nd Cleaner	10		1			1	2	9.0	154
Po 3rd Cleaner	5		1			1	2	9.0	167
Total	875	50	74	30			42		

Check Malvern Target ~25 um

Target pH 9.5

Check Malvern size, target 20-25 um

Target pH 9.0

Target pH 9.0

* Add as required.

Stage	Rougher/Scavenger	Po Rougher	Cu/Ni 1st/2nd Cleaner	Po 1st & 2nd Cl
Flotation Cell	2 kg float cell	2 kg float cell	500g/250g float cell	250g float cell
Speed: r.p.m.	1800	1800	1500/1200	1200

Test: LCT-2

Project: 18559-01

Date: August 4, 2021

Operator: Deepak, Marteen

Purpose:

Based on F-19

Procedure:

As outlined below.

Feed:

2kg SN Comp -10 mesh

Freezer\SEC-11C

Grind:

34 minutes at 65% solids in 2 kg Rod Mill # 3

P₈₀ =

Regrind

16 minutes at 50% solids in 2 kg Rod Mill for Cu/Ni R.Conc

P₈₀ =

12 minutes at 50% solids in Attrition Mill for Po R.Conc & Cu/Ni Scalp Conc - Ceramic balls

P₈₀ =

4.5mm

Conditions:

Cycle D

Stage	Reagents added, grams per tonne				Time, minutes			pH	ORP, mV
	Lime	DETA	PAX	MIBC*	Grind	Cond.	Froth		
Grind	625		5		34				
Cu/Ni Rougher No. 1	25		2.5	5		1	2	9.0	50
Cu/Ni Rougher No. 2	25		5	5		1	2	9.0	50
Cu/Ni Rougher No. 3	25		5	5		1	2	9.0	50
Cu/Ni Rougher No. 4	25		2.5			1	1	9.0	50
Cu/Ni Cleaning - Cu/Ni Ro Conc 1-3									
Regrind (2kg Rod Mill)	250	25	2		22.5			9.3	172
Cu/Ni 1st Cleaner No.1	35		2			1	2	9.5	127
Cu/Ni 1st Cleaner No.2	40		5	2.5		1	3	9.5	138
Cu/Ni Cleaner Scav	60		5			1	3	9.5	135
Cu/Ni Cleaner Scalp	40		10	2.5			5	9.5	141
Po Rougher No. 1	-		10			1	3	8.3	50
Po Rougher No. 2	-		10	5		1	5	8.1	50
Po Rougher No. 3	-		10	5		1	5	8.0	50
Po Cleaning on (Po Ro Con 1-3+Cu/Ni Cleaner Scalp Conc) Add Cu/Ni Cleaner Scalp Conc Starting Cycle B									
Regrind (Attrition Mill, Ceramic balls)	200	25	0		30			9.0	105
Po 1st Cleaner-1	0		4			1	1	9.0	105
Po 1st Cleaner-2	30		2			1	1	9.0	167
Po 1st Cleaner-3	25		2			1	1	9.0	170
Po 2nd Cleaner	10		1			1	2	9.0	167
Po 3rd Cleaner	5		1			1	2	9.0	160
Total	795	50	79	30			40		

Check Malvern Target ~25 um

Target pH 9.5

Check Malvern size, target 20-25 um

Target pH 9.0

Target pH 9.0

* Add as required.

Stage	Rougher/Scavenger	Po Rougher	Cu/Ni 1st/2nd Cleaner	Po 1st & 2nd Cl
Flotation Cell	2 kg float cell	2 kg float cell	500g/250g float cell	250g float cell
Speed: r.p.m.	1800	1800	1500/1200	1200

Test: LCT-2

Project: 18559-01

Date: August 4, 2021

Operator: Deepak, Marteen

Purpose:

Based on F-19

Procedure:

As outlined below.

Feed:

2kg SN Comp -10 mesh

Freezer\SEC-11C

Grind:

34 minutes at 65% solids in 2 kg Rod Mill # 3

P₈₀ =

Regrind

16 minutes at 50% solids in 2 kg Rod Mill for Cu/Ni R.Conc

P₈₀ =

12 minutes at 50% solids in Attrition Mill for Po R.Conc & Cu/Ni Scalp Conc - Ceramic balls

P₈₀ =

4.5mm

Conditions:

Cycle E

Stage	Reagents added, grams per tonne				Time, minutes			pH	ORP, mV
	Lime	DETA	PAX	MIBC*	Grind	Cond.	Froth		
Grind	625		5		34				
Cu/Ni Rougher No. 1	35		2.5	5		1	2	9.0	0
Cu/Ni Rougher No. 2	20		5	5		1	2	9.0	25
Cu/Ni Rougher No. 3	35		5	5		1	2	9.0	25
Cu/Ni Rougher No. 4	25		2.5			1	1	9.0	50
Cu/Ni Cleaning - Cu/Ni Ro Conc 1-3									
Regrind (2kg Rod Mill)	250	25	2		22.5			9.0	175
Cu/Ni 1st Cleaner No.1	5		2			1	2	9.5	138
Cu/Ni 1st Cleaner No.2	40		5	2.5		1	3	9.5	142
Cu/Ni Cleaner Scav	55		5			1	3	9.5	141
Cu/Ni Cleaner Scalp	45		10				5	9.5	140
Po Rougher No. 1	-		10			1	3	8.3	50
Po Rougher No. 2	-		10	5		1	5	8.1	50
Po Rougher No. 3	-		10	5		1	5	8.0	50
Po Cleaning on (Po Ro Con 1-3+Cu/Ni Cleaner Scalp Conc) Add Cu/Ni Cleaner Scalp Conc Starting Cycle B									
Regrind (Attrition Mill, Ceramic balls)	200	25	0		30			9.1	160
Po 1st Cleaner-1	0		4			1	1	9.0	160
Po 1st Cleaner-2	15		2			1	1	9.0	160
Po 1st Cleaner-3	10		2			1	1	9.0	166
Po 2nd Cleaner	5		1			1	2	9.0	153
Po 3rd Cleaner	5		1			1	2	9.0	143
Total	745	50	79	27.5			40		

Check Malvern Target ~25 um

Target pH 9.5

Check Malvern size, target 20-25 um

Target pH 9.0

Target pH 9.0

* Add as required.

Stage	Rougher/Scavenger	Po Rougher	Cu/Ni 1st/2nd Cleaner	Po 1st & 2nd Cl
Flotation Cell	2 kg float cell	2 kg float cell	500g/250g float cell	250g float cell
Speed: r.p.m.	1800	1800	1500/1200	1200

Test: LCT-2

Project: 18559-01

Date: August 4, 2021

Operator: Deepak, Marteen

Purpose:

Based on F-19

Procedure:

As outlined below.

Feed:

2kg SN Comp -10 mesh

Freezer\SEC-11C

Grind:

34 minutes at 65% solids in 2 kg Rod Mill # 3

P₈₀ =

Regrind

16 minutes at 50% solids in 2 kg Rod Mill for Cu/Ni R.Conc

P₈₀ =

12 minutes at 50% solids in Attrition Mill for Po R.Conc & Cu/Ni Scalp Conc - Ceramic balls

P₈₀ =

4.5mm

Conditions:

Cycle F

Stage	Reagents added, grams per tonne				Time, minutes			pH	ORP, mV
	Lime	DETA	PAX	MIBC*	Grind	Cond.	Froth		
Grind	625		5		34				
Cu/Ni Rougher No. 1	25		0	5		1	2	9.0	50
Cu/Ni Rougher No. 2	25		5	5		1	2	9.0	50
Cu/Ni Rougher No. 3	20		5	0		1	2	9.0	50
Cu/Ni Rougher No. 4	25		2.5	0		1	1	9.0	50
Cu/Ni Cleaning - Cu/Ni Ro Conc 1-3									
Regrind (2kg Rod Mill)	250	25	2		22.5			9.0	139
Cu/Ni 1st Cleaner No.1	5		2			1	2	9.5	133
Cu/Ni 1st Cleaner No.2	40		5	2.5		1	3	9.5	129
Cu/Ni Cleaner Scav	55		5			1	3	9.5	132
Cu/Ni Cleaner Scalp	50		10				5	9.5	133
Po Rougher No. 1	-		10			1	3	8.4	50
Po Rougher No. 2	-		10	5		1	5	8.2	50
Po Rougher No. 3	-		10	5		1	5	8.1	50
Po Cleaning on (Po Ro Con 1-3+Cu/Ni Cleaner Scalp Conc) Add Cu/Ni Cleaner Scalp Conc Starting Cycle B									
Regrind (Attrition Mill, Ceramic balls)	200	25	0		30			8.8	90
Po 1st Cleaner-1	0		4			1	1	9.0	101
Po 1st Cleaner-2	5		2			1	1	9.0	132
Po 1st Cleaner-3	45		2			1	1	9.0	148
Po 2nd Cleaner	5		1			1	2	9.0	155
Po 3rd Cleaner	10		1			1	2	9.0	156
Total	760	50	76.5	22.5			40		

Check Malvern Target ~25 um

Target pH 9.5

Check Malvern size, target 20-25 um

Target pH 9.0

Target pH 9.0

* Add as required.

Stage	Rougher/Scavenger	Po Rougher	Cu/Ni 1st/2nd Cleaner	Po 1st & 2nd Cl
Flotation Cell	2 kg float cell	2 kg float cell	500g/250g float cell	250g float cell
Speed: r.p.m.	1800	1800	1500/1200	1200

Metallurgical Projection (C-F)

Product	Weight		Assays, %							% Distribution							
	g	%	Cu	Ni	S	Other	Cp	Pn	Po	Gn	Cu	Ni	S	Cp	Pn	Po	Gn
Cu/Ni 1st CI Conc	1062	8.7	11.8	8.45	35.1		34.2	22.9	40.6	2.4	92.8	61.1	18.8	92.8	71.4	9.6	0.4
Cu/Ni Scalp Tail	991	8.2	0.21	1.08	34.2		0.62	1.8	86.6	11.0	1.6	7.3	17.1	1.6	5.2	19.1	1.6
Po 3rd CI Conc	114	0.9	1.83	6.92	36.5		5.31	18.2	74.3	2.2	1.5	5.4	2.1	1.5	6.1	1.9	0.0
Combined Cu/Ni Conc	1176	9.7	10.8	8.30	35.3		31.4	22.5	43.8	2.3	94.3	66.4	20.9	94.3	77.5	11.5	0.4
Po 1st CI Tails	2898	23.9	0.17	1.09	34.5		0.51	1.81	87.7	10.0	3.8	21.5	50.5	3.8	15.4	56.5	4.2
Po Rougher Tail	7075	58.3	0.01	0.10	3.22		0.02	0.10	8.26	91.6	0.4	4.8	11.5	0.4	2.0	13.0	93.9
Head (Calc.)	12140	100	1.11	1.21	16.3		3.22	2.81	37.1	56.9	100	100	100	100	100	100	100
Head (Dir.)			1.07	1.17	16.5		3.10	2.69	37.7	56.5							

Metallurgical Balance

Product	Weight		Assays, %							% Distribution							
	g	%	Cu	Ni	S	Other	Cp	Pn	Po	Gn	Cu	Ni	S	Cp	Pn	Po	Gn
LCT-2 Cu/Ni 1st CI Conc - A	174.5	1.4	10.8	7.84	35.5	45.9	31.3	21.1	45.6	1.9	14.6	9.6	3.1	14.6	11.2	1.8	0.0
LCT-2 Cu/Ni 1st CI Conc - B	158.9	1.3	10.6	6.92	35.8	46.7	30.7	18.5	49.2	1.6	13.1	7.7	2.9	13.1	9.0	1.7	0.0
LCT-2 Cu/Ni 1st CI Conc - C	135.9	1.1	15.8	9.22	34.3	40.7	45.8	25.3	25.8	3.1	16.6	8.8	2.4	16.6	10.5	0.8	0.1
LCT-2 Cu/Ni 1st CI Conc - D	177.4	1.5	10.8	8.10	35.5	45.6	31.3	21.9	45.0	1.8	14.9	10.1	3.2	14.9	11.8	1.8	0.0
LCT-2 Cu/Ni 1st CI Conc - E	185.3	1.5	10.9	8.29	35.2	45.6	31.6	22.4	43.5	2.5	15.7	10.8	3.3	15.7	12.7	1.8	0.1
LCT-2 Cu/Ni 1st CI Conc - F	209.4	1.7	10.8	8.40	35.3	45.5	31.3	22.7	43.8	2.2	17.5	12.3	3.7	17.5	14.5	2.0	0.1
LCT-2 Cu/Ni CI Scav Conc-F	69.9	0.6	1.19	4.06	36.5	58.3	3.45	10.1	83.0	3.4	0.6	2.0	1.3	0.6	2.2	1.3	0.0
LCT-2 Cu/Ni CI Scalp Conc-F	143.4	1.2	0.29	1.58	36.6	61.5	0.84	3.11	91.6	4.4	0.3	1.6	2.7	0.3	1.4	2.9	0.1
LCT-2 Cu/Ni CI Scalp Tails- A	184.8	1.5	0.15	0.89	32.5	66.5	0.43	1.31	82.9	15.4	0.2	1.2	3.0	0.2	0.7	3.4	0.4
LCT-2 Cu/Ni CI Scalp Tails- B	141.7	1.2	0.41	1.85	32.6	65.1	1.19	4.02	80.2	14.6	0.5	1.8	2.3	0.5	1.7	2.5	0.3
LCT-2 Cu/Ni CI Scalp Tails- C	205.4	1.7	0.33	1.57	35.0	63.1	0.96	3.14	87.3	8.6	0.5	2.3	3.6	0.5	2.0	4.0	0.3
LCT-2 Cu/Ni CI Scalp Tails- D	166.6	1.4	0.17	0.88	34.2	64.8	0.49	1.22	87.3	10.9	0.2	1.0	2.9	0.2	0.6	3.2	0.3
LCT-2 Cu/Ni CI Scalp Tails- E	130.7	1.1	0.18	0.85	33.6	65.4	0.52	1.16	85.8	12.5	0.2	0.8	2.2	0.2	0.5	2.5	0.2
LCT-2 Cu/Ni CI Scalp Tails-F	157.8	1.3	0.13	0.84	33.5	65.5	0.38	1.13	85.7	12.8	0.2	0.9	2.7	0.2	0.5	3.0	0.3
LCT-2 Po 3rd CI Conc-A	9.2	0.1	0.29	1.62	38.4	59.7	0.84	3.16	96.3	-0.3	0.0	0.1	0.2	0.0	0.1	0.2	0.0
LCT-2 Po 3rd CI Conc-B	35.8	0.3	0.63	3.84	37.4	58.1	1.83	9.45	87.4	1.3	0.2	1.0	0.7	0.2	1.0	0.7	0.0
LCT-2 Po 3rd CI Conc-C	25.5	0.2	2.18	6.73	36.8	54.3	6.32	17.7	74.7	1.3	0.4	1.2	0.5	0.4	1.4	0.4	0.0
LCT-2 Po 3rd CI Conc-D	19.9	0.2	1.74	8.22	36.3	53.7	5.04	21.8	71.0	2.1	0.3	1.1	0.4	0.3	1.3	0.3	0.0
LCT-2 Po 3rd CI Conc-E	14.2	0.1	1.81	6.98	36.7	54.5	5.25	18.3	74.8	1.6	0.2	0.7	0.3	0.2	0.8	0.2	0.0
LCT-2 Po 3rd CI Conc-F	16.5	0.1	1.42	5.60	36	57.0	4.12	14.5	77.4	4.1	0.2	0.6	0.3	0.2	0.7	0.3	0.0
LCT-2 Po 3rd CI Tails-F	15.5	0.1	0.34	1.87	35.9	61.9	0.99	4.0	89.0	6.1	0.0	0.2	0.3	0.0	0.2	0.3	0.0
LCT-2 Po 2nd CI Tails-F	63.7	0.5	0.23	1.41	33.6	64.8	0.67	2.74	84.3	12.3	0.1	0.6	1.1	0.1	0.5	1.2	0.1
LCT-2 Po 1st CI Tails-A	238.9	2.0	0.07	0.73	34.3	64.9	0.20	0.79	88.2	10.8	0.1	1.2	4.1	0.1	0.6	4.7	0.4
LCT-2 Po 1st CI Tails-B	467.1	3.9	0.07	0.78	33.8	65.4	0.19	0.95	86.8	12.1	0.2	2.6	8.0	0.2	1.4	9.0	0.8
LCT-2 Po 1st CI Tails-C	498.4	4.1	0.17	1.01	34.7	64.1	0.49	1.57	88.3	9.6	0.7	3.5	8.7	0.7	2.4	9.7	0.7
LCT-2 Po 1st CI Tails-D	489.7	4.0	0.19	1.26	34.5	64.1	0.55	2.28	87.2	10.0	0.7	4.3	8.5	0.7	3.4	9.4	0.7
LCT-2 Po 1st CI Tails-E	451.6	3.7	0.19	1.10	34.6	64.1	0.55	1.83	87.8	9.8	0.7	3.5	7.9	0.7	2.5	8.8	0.6
LCT-2 Po 1st CI Tails-F	492.4	4.1	0.15	1.00	34.4	64.5	0.43	1.55	87.6	10.4	0.6	3.5	8.6	0.6	2.3	9.5	0.7
LCT-2 Po Ro Tails-A	1160	9.6	0.02	0.11	3.29	96.6	0.05	0.12	84.0	91.4	0.2	0.9	1.9	0.2	0.4	2.2	15.4
LCT-2 Po Ro Tails-B	1169	9.6	<0.01	0.09	2.84	97.1	0.01	0.08	7.29	92.6	0.0	0.7	1.7	0.0	0.3	1.9	15.7
LCT-2 Po Ro Tails-C	1174	9.7	<0.01	0.09	2.99	96.9	0.01	0.09	7.68	92.2	0.0	0.8	1.8	0.0	0.3	2.0	15.7
LCT-2 Po Ro Tails-D	1151	9.5	<0.01	0.08	2.18	97.7	0.01	0.07	5.59	94.3	0.0	0.6	1.3	0.0	0.2	1.4	15.7
LCT-2 Po Ro Tails-E	1223	10.1	0.01	0.13	4.52	95.3	0.04	0.14	11.6	88.2	0.1	1.1	2.8	0.1	0.5	3.1	15.6
LCT-2 Po Ro Tails-F	1170	9.6	<0.01	0.09	3.11	96.8	0.01	0.08	7.99	91.9	0.0	0.8	1.8	0.0	0.3	2.1	15.6
Head (Calc.)	12126	100	1.06	1.18	16.3	81.4	3.08	2.71	37.3	56.9	100	100	100	100	100	100	100
Head (Dir.)			1.07	1.17	16.5	81.3	3.10	2.69	37.7	56.5							

Use 0.005 for <0.01

Combined Products

Product	Weight		Assays, %							% Distribution							
	g	%	Cu	Ni	S	Other	Cp	Pn	Po	Gn	Cu	Ni	S	Cp	Pn	Po	Gn
Cu/Ni 1st CI Conc A-F	8.6	11.4	8.12	35.3	45.1	33.2	22.0	42.7	2.2	92.4	59.3	18.6	92.4	69.7	9.8	0.3	
Cu/Ni Scalp Tail A-F	8.1	0.23	1.15	33.6	65.0	0.66	2.02	85.0	12.3		1.8	8.0	16.8	1.8	6.1	18.6	1.8
Cu/Ni CI Scav Conc F	0.6	1.19	4.06	36.5	58.3	3.4	10.1	83.0	3.4		0.6	2.0	1.3	0.6	2.2	1.3	0.0
Cu/Ni CI Scalp Conc F	1.2	0.29	1.58	36.6	61.5	0.84	3.11	91.6	4.4		0.3	1.6	2.7	0.3	1.4	2.9	0.1
Po 3rd CI Conc A-F	1.0	1.36	5.61	36.9	56.1	3.94	14.5	79.9	1.7	1.3	4.8	2.3	1.3	5.3	2.1	0.0	
Po 1st CI Tails A-F	21.8	0.15	1.00	34.4	64.5	0.42	1.56	87.6	10.4		3.0	18.6	45.8	3.0	12.6	51.1	4.0
Po 3rd CI Tails F	0.1	0.34	1.87	35.9	61.9	0.99	3.95	89.0	6.1		0.0	0.2	0.3	0.0	0.2	0.3	0.0
Po 2nd CI Tails F	0.5	0.23	1.41	33.6	64.8	0.67	2.74	84.3	12.3		0.1	0.6	1.1	0.1	0.5	1.2	0.1
Po Ro Tail A-F	58.1	0.01	0.10	3.17	96.7	0.02	0.10	8.12	91.8		0.5	4.9	11.3	0.5	2.1	12.7	93.7
Head (calc)	100		1.06	1.18	16.3	81.4	3.08	2.71	37.28	56.9	100	100	100	100	100	100	100

Stability

	Weight		Assays,%		
	g	%	Cu	Ni	S
Total In All Cycles	12126	100	1.06	1.18	16.33
Average In Per Cycle	2021	16.7			

Total Products Out Per Cycle	Weight		Units out as a % of Units in/Cycle		
	g	Wt %	Cu	Ni	S
Cycle A	1768	87.5	90.8	77.9	74.5
Cycle B	1973	97.6	83.9	82.9	93.2
Cycle C	2039	100.9	109.8	99.4	101.8
Cycle D	2004	99.2	96.7	103.3	97.4
Cycle E	2005	99.2	101.1	101.1	98.8
Cycle F	2046	101.2	111.0	108.9	102.6

Cycle Statistics (Least Squares)

242	11	253
266	189	455
98	80	177
12	6	18
2	4	5
122	95	217

Cycle Statistics (Least Squares)

0.4	0.77	1.2
21.6	20.56	42.2
8.6	9.40	18.0

Average of B-F	99.6	100.5	99.1	98.7
Average of C-F	100.1	104.7	103.2	100.1
Average of D-F	99.9	102.9	104.5	99.6

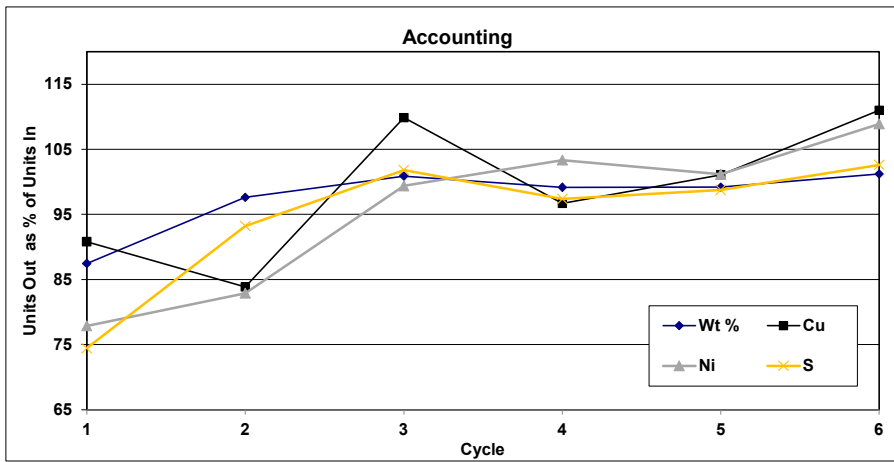

Test: LCT-3**Project:** 18559-01**Date:** August 10, 2021**Operator:** Deepak**Purpose:**

Cu Sep LCT, Based on F-19

Procedure:

As outlined below.

Feed:

4*~200 g LCT-2 Cu/Ni 1st Cl Conc, 3*~200 g LCT-1 Cu/N Freezer\SEC-11C

Grind:

5 minutes at 50% solids in Pebble Mill

P₈₀ =

* adjust dosage based on visual

Cycle A: ~200 g LCT-2 Cu/Ni Conc

Stage	Reagents added, grams per tonne			Time, minutes			pH	ORP, mV
	Lime	PAX	MIBC*	Grind	Cond.	Froth		
Polish Grind (Pebble mill)	625			5			11.4	50
Cu Ro 1	0	0.5				2	11.5	50
Cu Ro 2		0.5				2	11.0	50
Cu Ro Scav		1			1	1	10.1	101
Cu 1st Cl	100	0			1	3	11.5	23
Cu 2nd Cl	100	0			1	3	11.5	24
Cu 3rd Cl	105	0			1	2.5	11.5	27

Cycle B: ~200 g LCT-2 Cu/Ni Conc

Stage	Reagents added, grams per tonne			Time, minutes			pH	ORP, mV
	Lime	PAX	MIBC*	Grind	Cond.	Froth		
Polish Grind (Pebble mill)	625			5			11.5	31
<i>Grind Discharge+Ro Scav Conc+1st Cl Tails</i>								
Cu Ro 1	0	1				2	11.5	30
Cu Ro 2		0				2	11.0	56
Cu Ro Scav		1			1	1	10.4	84
<i>Ro Conc+2nd Cl Tails</i>								
Cu 1st Cl	50	0			1	3	11.5	26
<i>1st Cl Conc +3rd Cl Tails</i>								
Cu 2nd Cl	40	0			1	3	11.5	25
Cu 3rd Cl	25	0			1	2.5	11.5	25

Cycle C: ~200 g LCT-2 Cu/Ni Conc

Stage	Reagents added, grams per tonne			Time, minutes			pH	ORP, mV
	Lime	PAX	MIBC*	Grind	Cond.	Froth		
Polish Grind (Pebble mill)	625			5			11.3	37
<i>Grind Discharge+Ro Scav Conc+1st Cl Tails</i>								
Cu Ro 1	25	1				2	11.5	30
Cu Ro 2		0				2	10.6	70
Cu Ro Scav		1			1	1	9.9	114
<i>Ro Conc+2nd Cl Tails</i>								
Cu 1st Cl	125	0			1	3	11.5	23
<i>1st Cl Conc +3rd Cl Tails</i>								
Cu 2nd Cl	60	0			1	3	11.5	27
Cu 3rd Cl	60	0			1	2.5	11.5	18

Cycle D: ~200 g LCT-2 Cu/Ni Conc

Stage	Reagents added, grams per tonne			Time, minutes			pH	ORP, mV
	Lime	PAX	MIBC*	Grind	Cond.	Froth		
Polish Grind (Pebble mill)	750			5			11.6	29
Grind Discharge+Ro Scav Conc+1st CI Tails								
Cu Ro 1	0	0.5				2	11.5	29
Cu Ro 2		0				2	11.1	46
Cu Ro Scav		0.5			1	1	10.7	66
Ro Conc+2nd CI Tails								
Cu 1st CI	75	0			1	3	11.5	23
1st CI Conc +3rd CI Tails								
Cu 2nd CI	75	0			1	3	11.5	21
Cu 3rd CI	65	0			1	2.5	11.5	20

Cycle E: ~200 g LCT-1 Cu/Ni Conc

Stage	Reagents added, grams per tonne			Time, minutes			pH	ORP, mV
	Lime	PAX	MIBC*	Grind	Cond.	Froth		
Polish Grind (Pebble mill)	750			5			11.3	42
Grind Discharge+Ro Scav Conc+1st CI Tails								
Cu Ro 1	25	0.5				2	11.5	17
Cu Ro 2		0				2	11.5	40
Cu Ro Scav		0.5			1	1	11.5	61
Ro Conc+2nd CI Tails								
Cu 1st CI	65	0			1	3	11.5	18
1st CI Conc +3rd CI Tails								
Cu 2nd CI	55	0			1	3	11.5	24
Cu 3rd CI	70	0			1	2.5	11.5	16

Cycle F: ~200 g LCT-1 Cu/Ni Conc

Stage	Reagents added, grams per tonne			Time, minutes			pH	ORP, mV
	Lime	PAX	MIBC*	Grind	Cond.	Froth		
Polish Grind (Pebble mill)	750			5			11.6	18
Grind Discharge+Ro Scav Conc+1st CI Tails								
Cu Ro 1	0	0.5				2	11.6	14
Cu Ro 2		0				2	11.5	30
Cu Ro Scav		0.5			1	1	11.3	40
Ro Conc+2nd CI Tails								
Cu 1st CI	10	0			1	3	11.5	26
1st CI Conc +3rd CI Tails								
Cu 2nd CI	25	0			1	3	11.5	25
Cu 3rd CI	50	0			1	2.5	11.5	26

Cycle G: ~200 g LCT-1 Cu/Ni Conc

Stage	Reagents added, grams per tonne			Time, minutes			pH	ORP, mV
	Lime	PAX	MIBC*	Grind	Cond.	Froth		
Polish Grind (Pebble mill)	750			5			11.6	25
Grind Discharge+Ro Scav Conc+1st CI Tails								
Cu Ro 1	0	0.5				2	11.6	25
Cu Ro 2		0				2	11.4	31
Cu Ro Scav		0.5			1	1	11.2	44
Ro Conc+2nd CI Tails								
Cu 1st CI	50	0			1	3	11.5	26
1st CI Conc +3rd CI Tails								
Cu 2nd CI	65	0			1	3	11.5	24
Cu 3rd CI	75	0			1	2.5	11.5	25

TARGET WEIGHTS	Wt. (Dry g.)		Wt. (Wet w.Paper, g)		A	B	C	D	E	F	G
	Cycle B-D	Cycle E-G	Cycle B-D	Cycle E-G							
Cu 3rd CI Conc (exit)	52	76	74	102	57.81	85.11	96.14	103.02	97.55	94.85	97.48
Cu Ro Scav Tail (exit)	148	127	187	162	149.61	152.46	142.59	184.9	196.36	172.93	180.56
Cu 3rd CI Tails -F (exit)											26.79
Cu 2nd CI Tails -F (exit)											30.33
Cu 1st CI Tails -F (exit)											43.44
Cu Ro Scav Conc -F (exit)											19.69
Cu Ro Conc (intermediate)	65		89								

Stage	Rougher/Scavenger	Cu 1st/2nd/3rd Cleaner	
Flotation Cell	1 kg float cell	500g/250g float cell	
Speed: r.p.m.		1500/1200	

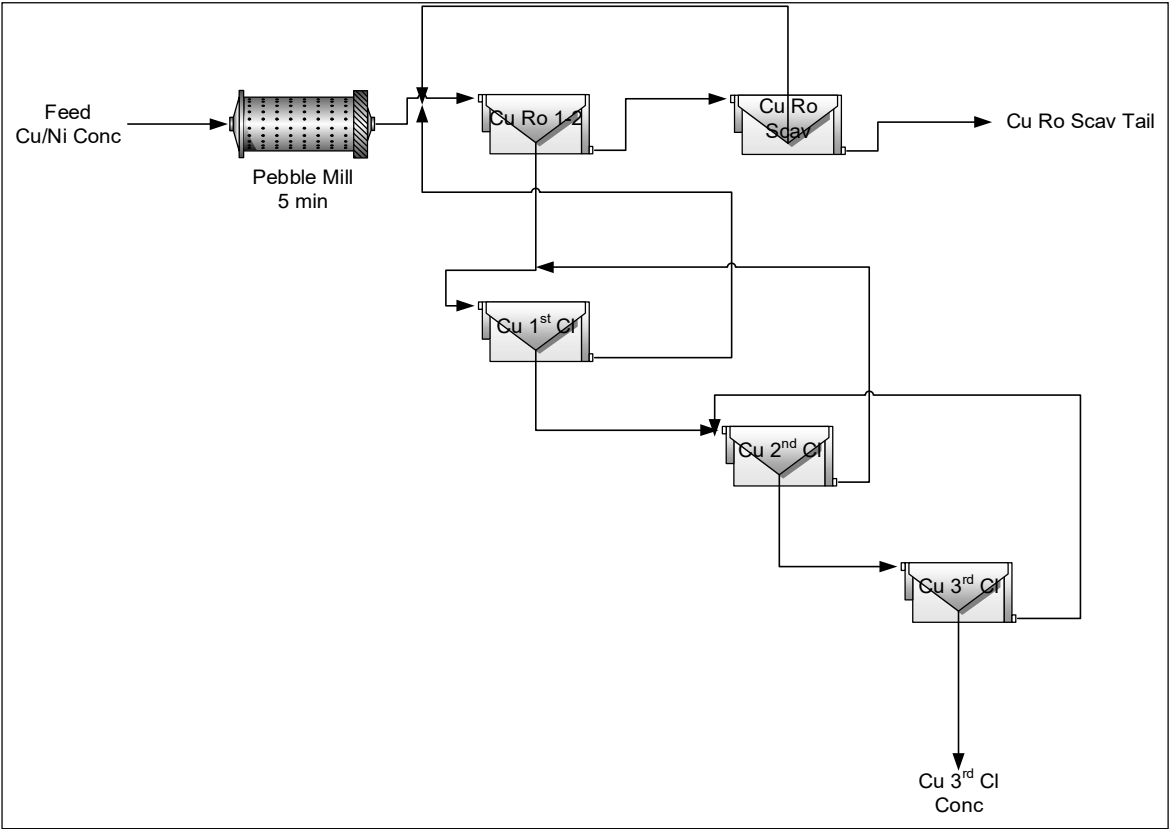

Metallurgical Projection (D)

Product	Wt		Assays, %							% Distribution					
	g	%	Cu	Ni	S	Cp	Pn	Po	Gn	Cu	Ni	S	Cp	Pn	Po
Cu 3rd Cl Conc 1-2	409	30.0	28.8	1.92	34.4	83.6	5.21	8.80	2.42	79.4	7.3	30.7	79.4	7.3	6.6
Cu Ro Scav Tail	952	70.0	3.21	10.5	33.3	9.30	28.4	53.7	8.60	20.6	92.7	69.3	20.6	92.7	93.4
Head (Calc.)	1361	100	10.9	7.92	33.6	31.6	21.4	40.2	6.74	100	100	100	100	100	100
Head (Dir.)															

Metallurgical Balance

Product	Weight		Assays, %							% Distribution					
	g	%	Cu	Ni	S	Cp	Pn	Po	Gn	Cu	Ni	S	Cp	Pn	Po
LCT-3 Cu 3rd Cl Conc-A	36.4	2.6	32.0	0.89	34.1	92.8	2.4	2.2	2.6	6.8	0.3	2.7	6.8	0.3	0.2
LCT-3 Cu 3rd Cl Conc-B	61.9	4.5	29.8	1.86	34.1	86.4	5.1	5.7	2.8	10.7	1.0	4.5	10.7	1.0	0.7
LCT-3 Cu 3rd Cl Conc-C	72.5	5.3	28.4	2.40	34.7	82.3	6.5	9.7	1.5	12.0	1.5	5.4	12.0	1.5	1.5
LCT-3 Cu 3rd Cl Conc1-D	33.5	2.4	30.2	1.62	34.4	87.5	4.4	6.0	2.1	5.9	0.5	2.5	5.9	0.5	0.4
LCT-3 Cu 3rd Cl Conc2-D	24.9	1.8	27.0	2.32	34.3	78.3	6.3	12.6	2.9	3.9	0.5	1.8	3.9	0.5	0.7
LCT-3 Cu 3rd Cl Conc3-D	6.9	0.5	21.1	3.89	34.7	61.2	10.4	25.6	2.8	0.8	0.2	0.5	0.8	0.2	0.4
LCT-3 Cu 3rd Cl Conc-E	74.7	5.4	30.8	0.71	34.2	89.3	1.9	6.1	2.8	13.4	0.4	5.5	13.4	0.4	0.9
LCT-3 Cu 3rd Cl Conc-F	72.9	5.3	30.6	0.57	34.5	88.7	1.47	7.7	2.1	13.0	0.3	5.4	13.0	0.3	1.2
LCT-3 Cu 3rd Cl Conc-G	75.2	5.5	31.2	0.53	34.4	90.4	1.39	5.9	2.2	13.6	0.3	5.5	13.6	0.3	0.9
LCT-3 Cu 3rd Cl Tail-G	9.4	0.7	18.1	2.81	33.3	52.5	7.35	32.5	7.7	1.0	0.2	0.7	1.0	0.2	0.6
LCT-3 Cu 2nd Cl Tail-G	12.1	0.9	11.7	5.93	32.7	33.9	15.9	40.5	9.7	0.8	0.6	0.8	0.8	0.6	1.0
LCT-3 Cu 1st Cl Tail-G	22.8	1.7	7.29	10.3	33.1	21.1	28.0	42.8	8.1	1.0	2.0	1.6	1.0	2.0	2.0
LCT-3 Cu Ro Scav Conc-G	4.1	0.3	15.2	3.85	34.4	44.1	10.1	40.6	5.2	0.4	0.1	0.3	0.4	0.1	0.3
LCT-3 Cu Ro Scav Conc-D	8.7	0.6	12.9	7.33	33.6	37.4	19.9	36.3	6.5	0.7	0.5	0.6	0.7	0.5	0.7
LCT-3 Cu Ro Scav Tail-A	107	7.7	3.64	9.77	33.5	10.6	26.4	54.8	8.3	2.3	8.8	7.7	2.3	8.7	12.2
LCT-3 Cu Ro Scav Tail-B	110	8.0	3.15	10.0	33.5	9.13	27.0	55.6	8.3	2.0	9.2	7.9	2.0	9.1	12.7
LCT-3 Cu Ro Scav Tail-C	102	7.4	2.39	10.0	33.3	6.93	27.0	57.1	9.0	1.4	8.5	7.3	1.4	8.5	12.1
LCT-3 Cu Ro Scav Tail-D	136	9.9	3.21	10.5	33.3	9.30	28.4	53.7	8.6	2.5	12.0	9.7	2.5	11.9	15.2
LCT-3 Cu Ro Scav Tail-E	147	10.6	3.14	15.5	33.5	9.10	42.5	42.3	6.1	2.7	19.1	10.5	2.7	19.2	12.9
LCT-3 Cu Ro Scav Tail-F	128	9.3	3.13	15.7	33.8	9.07	43.0	42.7	5.2	2.3	16.8	9.3	2.3	16.9	11.3
LCT-3 Cu Ro Scav Tail-G	135	9.8	3.70	15.2	33.9	10.7	41.6	42.6	5.0	2.9	17.2	9.8	2.9	17.3	11.9
Head (Calc.) A-D	699	50.7	12.0	7.31	33.7	34.9	19.8	38.9	6.4	49.0	42.9	50.6	49.0	42.6	56.7
Head (Calc.) E-G	680	49.3	12.9	10.0	33.9	37.4	27.4	30.6	4.7	51.0	57.1	49.4	51.0	57.4	43.3
Head (Calc.) A-G	1379	100	12.5	8.64	33.8	36.2	23.5	34.8	5.5	100	100	100	100	100	100
Head (Exp.) A-G	1398														
LCT-3 Cu 3rd Cl Conc D 1-3	65.3	4.7	28.0	2.13	34.4	81.2	5.8	10.6	2.5	10.6	1.2	4.8	10.6	1.2	1.4

Combined Products (A-D)

Product	Weight		Assays, %							% Distribution					
	g	%	Cu	Ni	S	Cp	Pn	Po	Gn	Cu	Ni	S	Cp	Pn	Po
Cu 3rd Cl Conc A-D	236.1	33.8	29.2	1.95	34.4	84.7	5.3	7.7	2.3	81.9	9.0	34.4	81.9	9.1	6.7
Cu 3rd Cl Scav Conc -D	8.7	1.2	12.9	7.33	33.6	37.4	19.9	36.3	6.5	1.3	1.2	1.2	1.3	1.2	1.2
Cu Ro Scav Tails A-D	454.4	65.0	3.11	10.1	33.4	9.0	27.3	55.2	8.5	16.8	89.7	64.4	16.8	89.7	92.1
Head (calc) A-D	699.2	100	12.0	7.31	33.7	34.9	19.8	38.9	6.4	100	100	100	100	100	100

Stability

	Weight		Assays,%		
	g	%	Cu	Ni	S
Total In All Cycles	699	100.0	12.0	7.31	33.7
Average In Per Cycle	175	25.0			

Total Products Out Per Cycle	Weight		Units out as a % of Units in/Cycle		
	g	Wt %	Cu	Ni	S
Cycle A	143	81.9	73.8	84.2	81.7
Cycle B	172	98.2	104.0	94.9	98.2
Cycle C	174	99.7	109.3	93.3	100.2
Cycle D	201	115.2	107.6	122.6	114.9

Cycle Statistics (Least Squares)

1015	67	1082
19	33	53
87	92	179
288	57	345

Cycle Statistics (Least Squares)

67.6	6.78	74.4
126.8	1.03	127.8

Average of B-D	104.4	107.0	103.6	104.4
Average of C-D	107.4	108.5	107.9	107.5

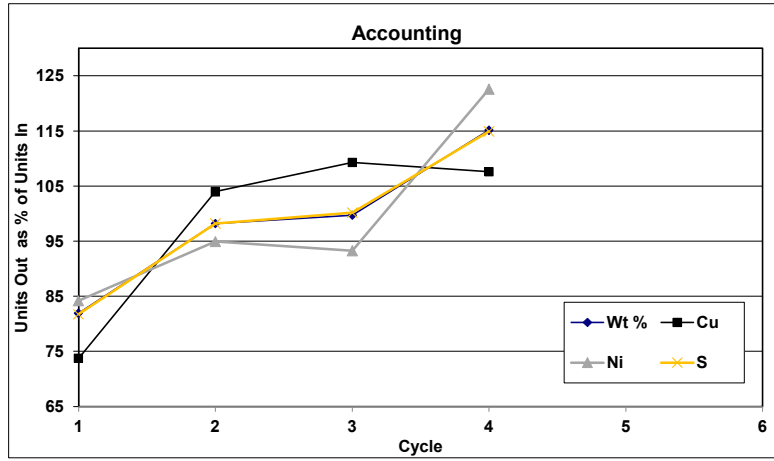

Metallurgical Projection (F-G)

Product	Wt		Assays, %							% Distribution					
	g	%	Cu	Ni	S	Cp	Pn	Po	Gn	Cu	Ni	S	Cp	Pn	Po
Cu 3rd CI Conc	518	36.1	30.9	0.55	34.4	89.6	1.43	6.82	2.17	83.6	2.0	36.5	83.6	1.9	8.3
Cu Ro Scav Tail	917	63.9	3.42	15.4	33.9	9.92	42.3	42.6	5.13	16.4	98.0	63.5	16.4	98.1	91.7
Head (Calc.)	1436	100	13.3	10.1	34.1	38.7	27.5	29.7	4.06	100	100	100	100	100	100
Head (Dir.)															

Metallurgical Balance

Product	Wt		Assays, %							% Distribution					
	g	%	Cu	Ni	S	Cp	Pn	Po	Gn	Cu	Ni	S	Cp	Pn	Po
LCT-3 Cu 3rd CI Conc-A	36.4	2.6	32.0	0.89	34.1	92.8	2.4	2.2	2.6	6.8	0.3	2.7	6.8	0.3	0.2
LCT-3 Cu 3rd CI Conc-B	61.9	4.5	29.8	1.86	34.1	86.4	5.1	5.7	2.8	10.7	1.0	4.5	10.7	1.0	0.7
LCT-3 Cu 3rd CI Conc-C	72.5	5.3	28.4	2.40	34.7	82.3	6.5	9.7	1.5	12.0	1.5	5.4	12.0	1.5	1.5
LCT-3 Cu 3rd CI Conc1-D	33.5	2.4	30.2	1.62	34.4	87.5	4.4	6.0	2.1	5.9	0.5	2.5	5.9	0.5	0.4
LCT-3 Cu 3rd CI Conc2-D	24.9	1.8	27.0	2.32	34.3	78.3	6.3	12.6	2.9	3.9	0.5	1.8	3.9	0.5	0.7
LCT-3 Cu 3rd CI Conc3-D	6.9	0.5	21.1	3.89	34.7	61.2	10.4	25.6	2.8	0.8	0.2	0.5	0.8	0.2	0.4
LCT-3 Cu 3rd CI Conc-E	74.7	5.4	30.8	0.71	34.2	89.3	1.9	6.1	2.8	13.4	0.4	5.5	13.4	0.4	0.9
LCT-3 Cu 3rd CI Conc-F	72.9	5.3	30.6	0.57	34.5	88.7	1.47	7.7	2.1	13.0	0.3	5.4	13.0	0.3	1.2
LCT-3 Cu 3rd CI Conc-G	75.2	5.5	31.2	0.53	34.4	90.4	1.39	5.9	2.2	13.6	0.3	5.5	13.6	0.3	0.9
LCT-3 Cu 3rd CI Tail-G	9.4	0.7	18.1	2.81	33.3	52.5	7.35	32.5	7.7	1.0	0.2	0.7	1.0	0.2	0.6
LCT-3 Cu 2nd CI Tail-G	12.1	0.9	11.7	5.93	32.7	33.9	15.9	40.5	9.7	0.8	0.6	0.8	0.8	0.6	1.0
LCT-3 Cu 1st CI Tail-G	22.8	1.7	7.29	10.3	33.1	21.1	28.0	42.8	8.1	1.0	2.0	1.6	1.0	2.0	2.0
LCT-3 Cu Ro Scav Conc-G	4.1	0.3	15.2	3.85	34.4	44.1	10.1	40.6	5.2	0.4	0.1	0.3	0.4	0.1	0.3
LCT-3 Cu Ro Scav Conc-D	8.7	0.6	12.9	7.33	33.6	37.4	19.9	36.3	6.5	0.7	0.5	0.6	0.7	0.5	0.7
LCT-3 Cu Ro Scav Tail-A	107	7.7	3.64	9.77	33.5	10.6	26.4	54.8	8.3	2.3	8.8	7.7	2.3	8.7	12.2
LCT-3 Cu Ro Scav Tail-B	110	8.0	3.15	10.0	33.5	9.13	27.0	55.6	8.3	2.0	9.2	7.9	2.0	9.1	12.7
LCT-3 Cu Ro Scav Tail-C	102	7.4	2.39	10.0	33.3	6.93	27.0	57.1	9.0	1.4	8.5	7.3	1.4	8.5	12.1
LCT-3 Cu Ro Scav Tail-D	136	9.9	3.21	10.5	33.3	9.30	28.4	53.7	8.6	2.5	12.0	9.7	2.5	11.9	15.2
LCT-3 Cu Ro Scav Tail-E	147	10.6	3.14	15.5	33.5	9.10	42.5	42.3	6.1	2.7	19.1	10.5	2.7	19.2	12.9
LCT-3 Cu Ro Scav Tail-F	128	9.3	3.13	15.7	33.8	9.07	43.0	42.7	5.2	2.3	16.8	9.3	2.3	16.9	11.3
LCT-3 Cu Ro Scav Tail-G	135	9.8	3.70	15.2	33.9	10.7	41.6	42.6	5.0	2.9	17.2	9.8	2.9	17.3	11.9
Head (Calc.) A-D	699	50.7	12.0	7.31	33.7	34.9	19.8	38.9	6.4	49.0	42.9	50.6	49.0	42.6	56.7
Head (Calc.) E-G	680	49.3	12.9	10.0	33.9	37.4	27.4	30.6	4.7	51.0	57.1	49.4	51.0	57.4	43.3
Head (Calc.) A-G	1379	100	12.5	8.64	33.8	36.2	23.5	34.8	5.5	100	100	100	100	100	100
Head (Exp.) A-G	1398														
LCT-3 Cu 3rd CI Conc D 1-3	65.3	4.7	28.0	2.13	34.4	81.2	5.8	10.6	2.5	10.6	1.2	4.8	10.6	1.2	1.4

Combined Products (E-G)

Product	Weight		Assays, %							% Distribution					
	g	%	Cu	Ni	S	Cp	Pn	Po	Gn	Cu	Ni	S	Cp	Pn	Po
Cu 3rd CI Conc E-G	223	32.8	30.9	0.60	34.4	89.5	1.6	6.6	2.4	78.4	2.0	33.2	78.4	1.9	7.0
Cu 3rd CI Tails - G	9.4	1.4	18.1	2.81	33.3	52.5	7.3	32.5	7.7	1.9	0.4	1.4	1.9	0.4	1.5
Cu 2nd CI Tails - G	12.1	1.8	11.7	5.93	32.7	33.9	15.9	40.5	9.7	1.6	1.1	1.7	1.6	1.0	2.4
Cu 1st CI Tails - G	22.8	3.4	7.29	10.3	33.1	21.1	28.0	42.8	8.1	1.9	3.5	3.3	1.9	3.4	4.7
Cu Ro Scav Conc - G	4.1	0.6	15.2	3.85	34.4	44.1	10.1	40.6	5.2	0.7	0.2	0.6	0.7	0.2	0.8
Cu Ro Scav Tails E-G	409	60.1	3.32	15.5	33.7	9.6	42.4	42.5	5.5	15.5	92.9	59.8	15.5	93.0	83.6
Head (calc) E-G	680	100	12.9	10.0	33.9	37.4	27.4	30.6	4.7	100	100	100	100	100	100

Stability

	Weight		Assays,%		
	g	%	Cu	Ni	S
Total In All Cycles	680	100.0	12.9	10.0	33.9
Average In Per Cycle	227	33.3			

Total Products Out Per Cycle	Weight		Units out as a % of Units in/Cycle		
	g	Wt %	Cu	Ni	S
Cycle E	221	97.6	94.4	102.5	97.2
Cycle F	201	88.5	89.9	90.2	88.9
Cycle G	210	92.5	97.2	91.9	93.0

Cycle Statistics (Least Squares)

37	11	48
235	2	237
64	22	86

Cycle Statistics (Least Squares)

88.6	0.93	89.5
131.6	9.4	141.1

Average of E-G	92.9	93.8	94.9	93.0
Average of F-G	90.5	93.6	91.0	91.0

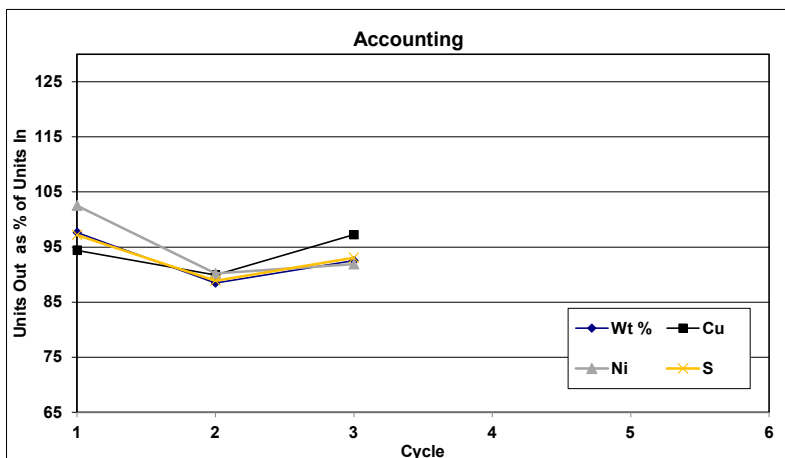



QEMSCAN DATA

prepared for:

North American Nickel

Project 18559-01

MI5012-JUL21

July 27, 2021

Prepared by:



Margot Aldis/Chris Gunning
Mineralogist/Senior Mineralogist

High Definition Mineralogical Analysis using QEMSCAN (Quantitative Evaluation of Materials by Scanning Electron Microscopy) (METH# 8.11.1) used by SGS Minerals Services

SGS Canada

P.O. Box 4300, 185 Concession Street, Lakefield, Ontario, Canada K0L 2H0
Tel. (705) 652-6365 www.sgs.com www.sgs.com/met

Member of the SGS Group (SGS SA)

North American Nickel
 18559-01
 MI5012-JUL21

High Definition Mineralogical Analysis using QEMSCAN (Quantitative Evaluation of Materials by Scanning Electron Microscopy)

Assay Reconciliation

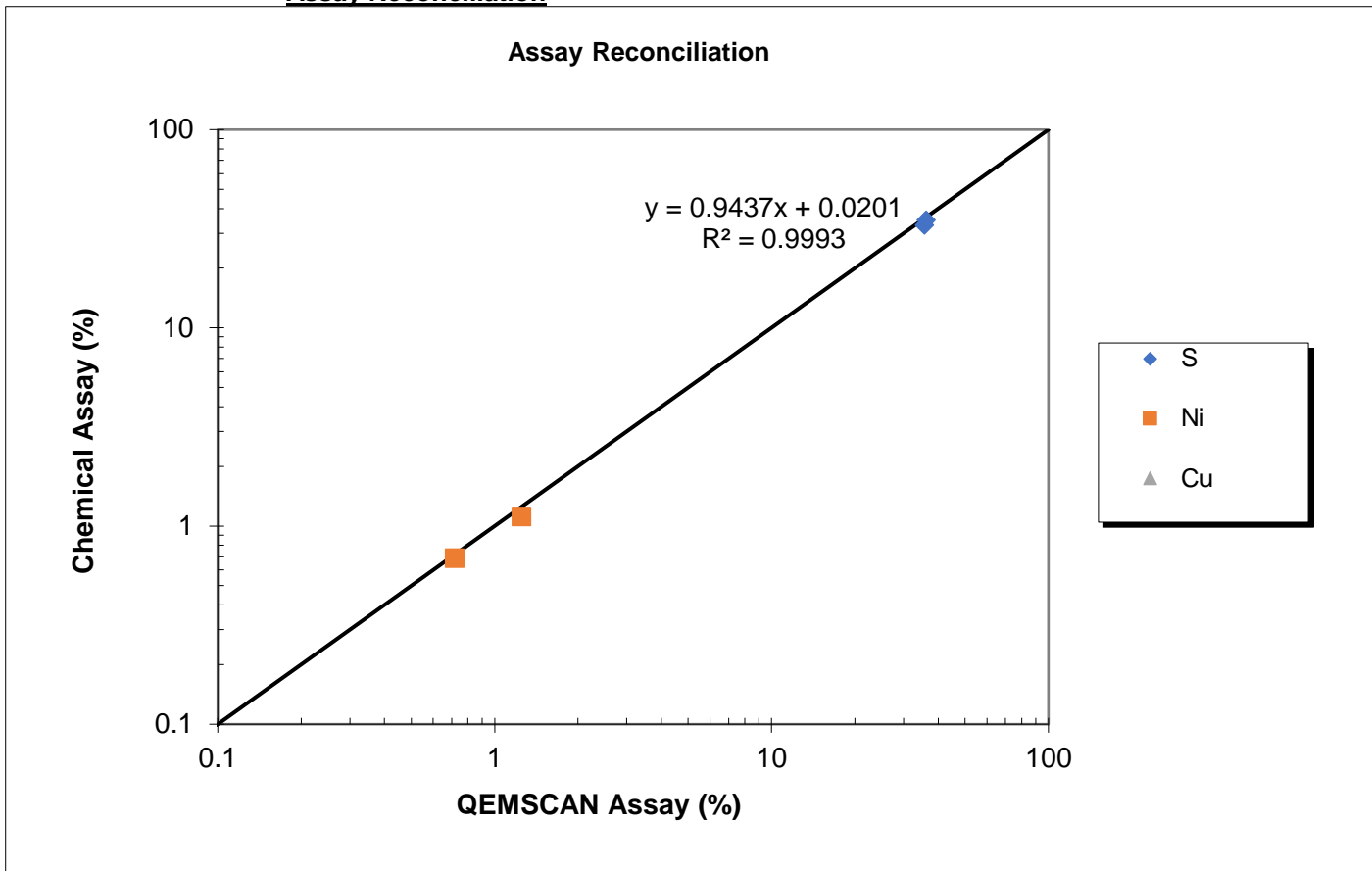

Sample	F8 Cu/Ni 1st Cleaner Tails	F8 Po 1st Cleaner Tails
Element	-300/+3um	-300/+3um
S (QEMSCAN)	36.21	35.70
S (Chemical)	34.90	33.00
Ni (QEMSCAN)	1.25	0.72
Ni (Chemical)	1.12	0.69
Cu (QEMSCAN)	0.01	0.03
Cu (Chemical)	0.09	0.08

North American Nickel
18559-01
MI5012-JUL21

High Definition Mineralogical Analysis using QEMSCAN (Quantitative Evaluation of Materials by Scanning Electron Microscopy)

Modals

Survey		18559-01 / MI5012-JUL21	
Project		North American Nickel	
Sample		F8 Cu/Ni 1st Cleaner Tails	F8 Po 1st Cleaner Tails
Fraction		-300/+3um	-300/+3um
Mass Size Distribution (%)		100.0	100.0
Calculated ESD Particle Size		17	16
		Sample	Sample
Mineral Mass (%)	Pyrrhotite	90.10	89.88
	Chalcopyrite	0.04	0.07
	Pentlandite	2.31	0.78
	Pyrite/Marcasite	0.16	0.02
	Other_Sulphides	0.03	0.10
	Fe-Oxides	1.95	3.62
	Other_Oxides	0.01	0.01
	Chlorite/Clays	1.32	1.27
	Biotite	0.15	0.19
	Talc	0.06	0.07
	Quartz	0.69	0.50
	Plagioclase	0.70	0.49
	Amphibole/Pyroxene	2.22	2.61
	K-Feldspar	0.05	0.02
	Epidote	0.07	0.07
	Titanite/sphene	0.01	0.02
	Other Silicates	0.05	0.09
	Carbonates	0.01	0.02
	Apatite	0.06	0.14
	Other	0.02	0.03
Total		100.00	100.00
Mean Grain Size by Frequency (µm)	Pyrrhotite	17	16
	Chalcopyrite	9	8
	Pentlandite	11	9
	Pyrite/Marcasite	10	8
	Other_Sulphides	9	9
	Fe-Oxides	13	11
	Other_Oxides	10	10
	Chlorite/Clays	10	9
	Biotite	13	12
	Talc	9	9
	Quartz	12	11
	Plagioclase	14	11
	Amphibole/Pyroxene	14	11
	K-Feldspar	12	10
	Epidote	9	11
	Titanite/sphene	8	11
	Other Silicates	10	9
	Carbonates	8	10
	Apatite	9	10
	Other	9	9

North American Nickel
 18559-01
 MI5012-JUL21

High Definition Mineralogical Analysis using QEMSCAN (Quantitative Evaluation of Materials by Scanning Electron Microscopy)

Cu Department - Absolute

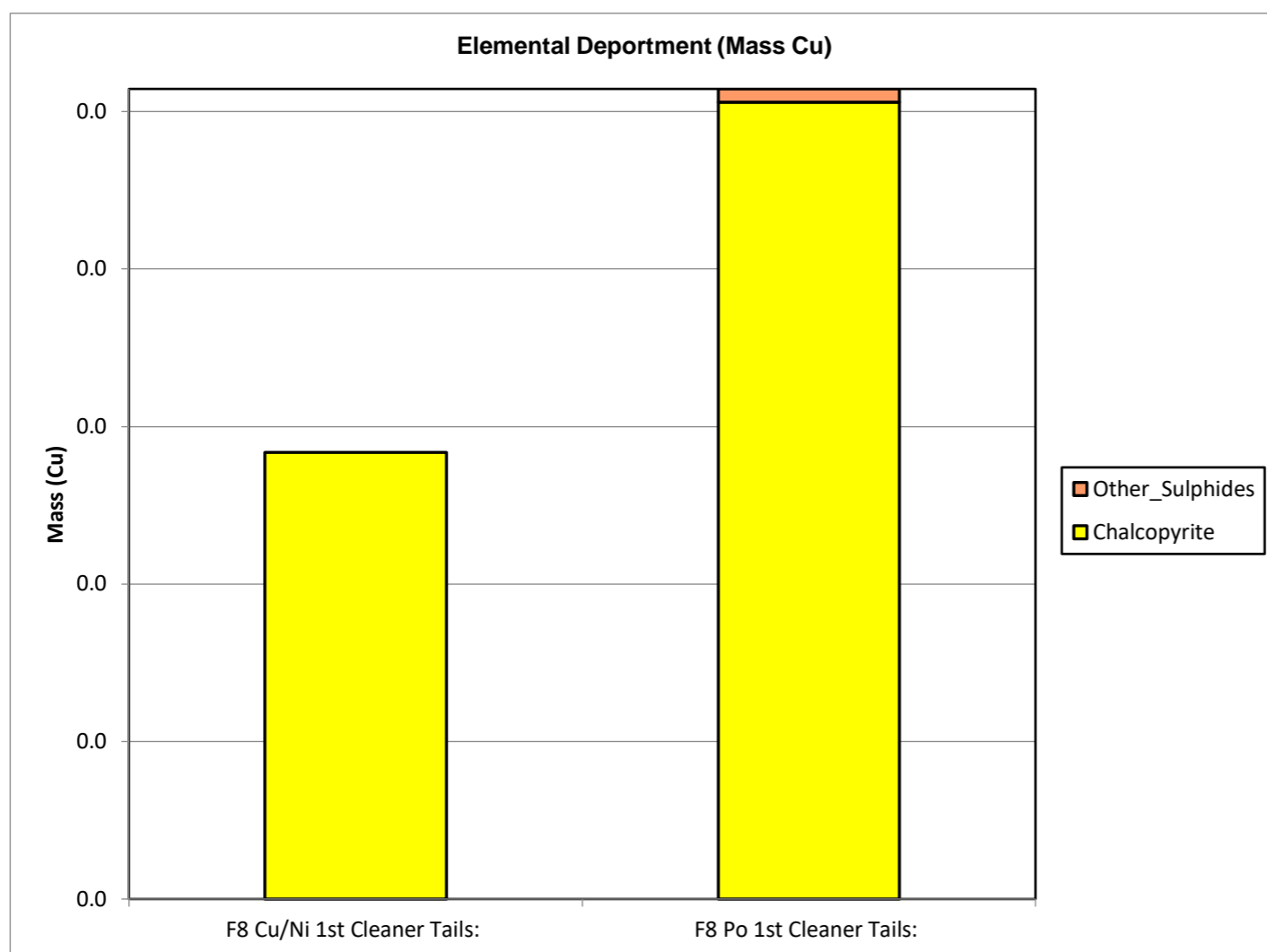

	F8 Cu/Ni 1st Cleaner Tails:	F8 Po 1st Cleaner Tails:
Chalcopyrite	0.01	0.03
Other_Sulphides	0.00	0.00
Total	0.01	0.03

Cu Department - Normalized

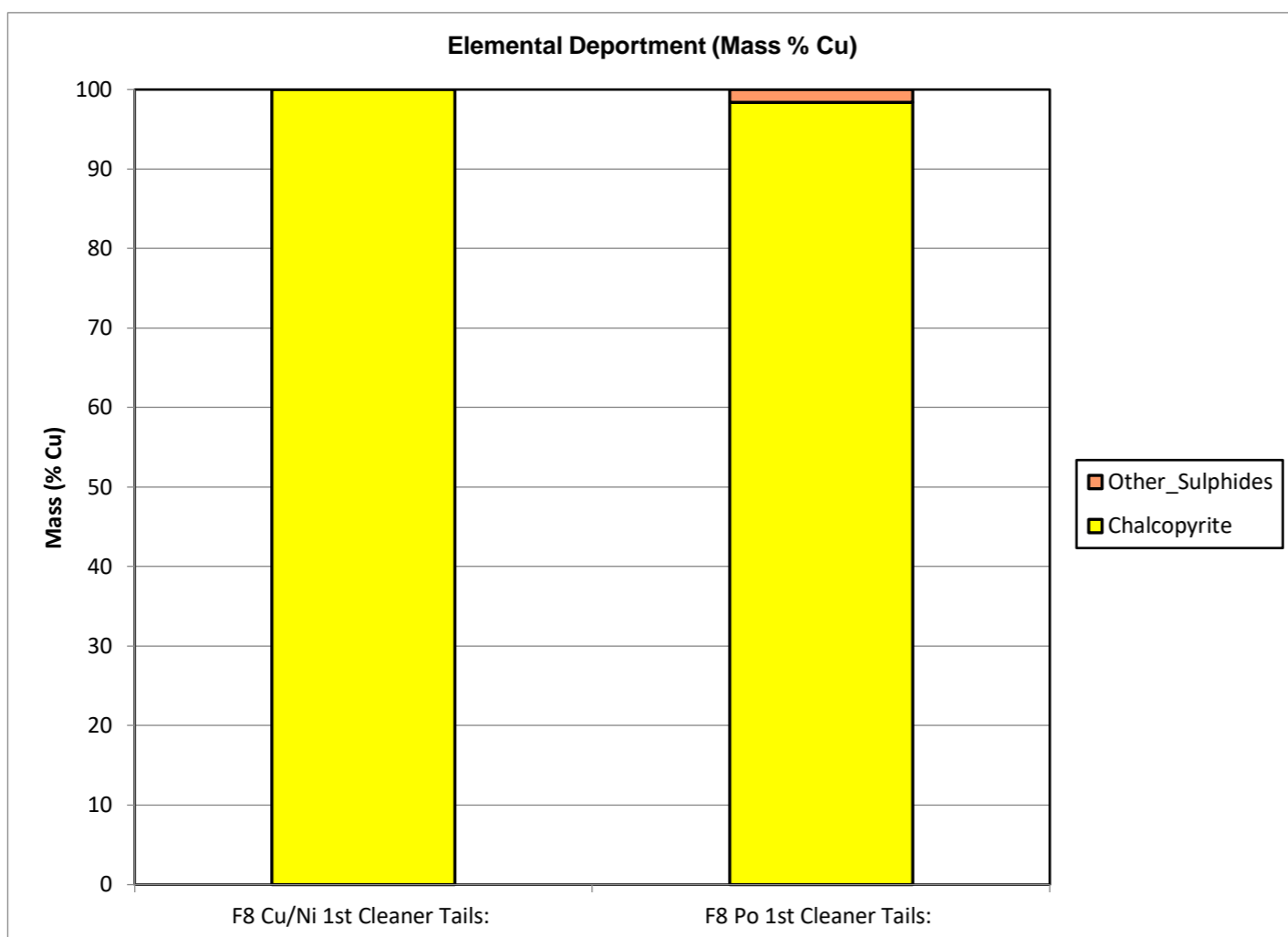

	F8 Cu/Ni 1st Cleaner Tails:	F8 Po 1st Cleaner Tails:
Chalcopyrite	100.00	98.38
Other_Sulphides	0.00	1.62
Total	100.00	100.00

North American Nickel
 18559-01
 MI5012-JUL21

High Definition Mineralogical Analysis using QEMSCAN (Quantitative Evaluation of Materials by Scanning Electron Microscopy)

Ni Department - Absolute

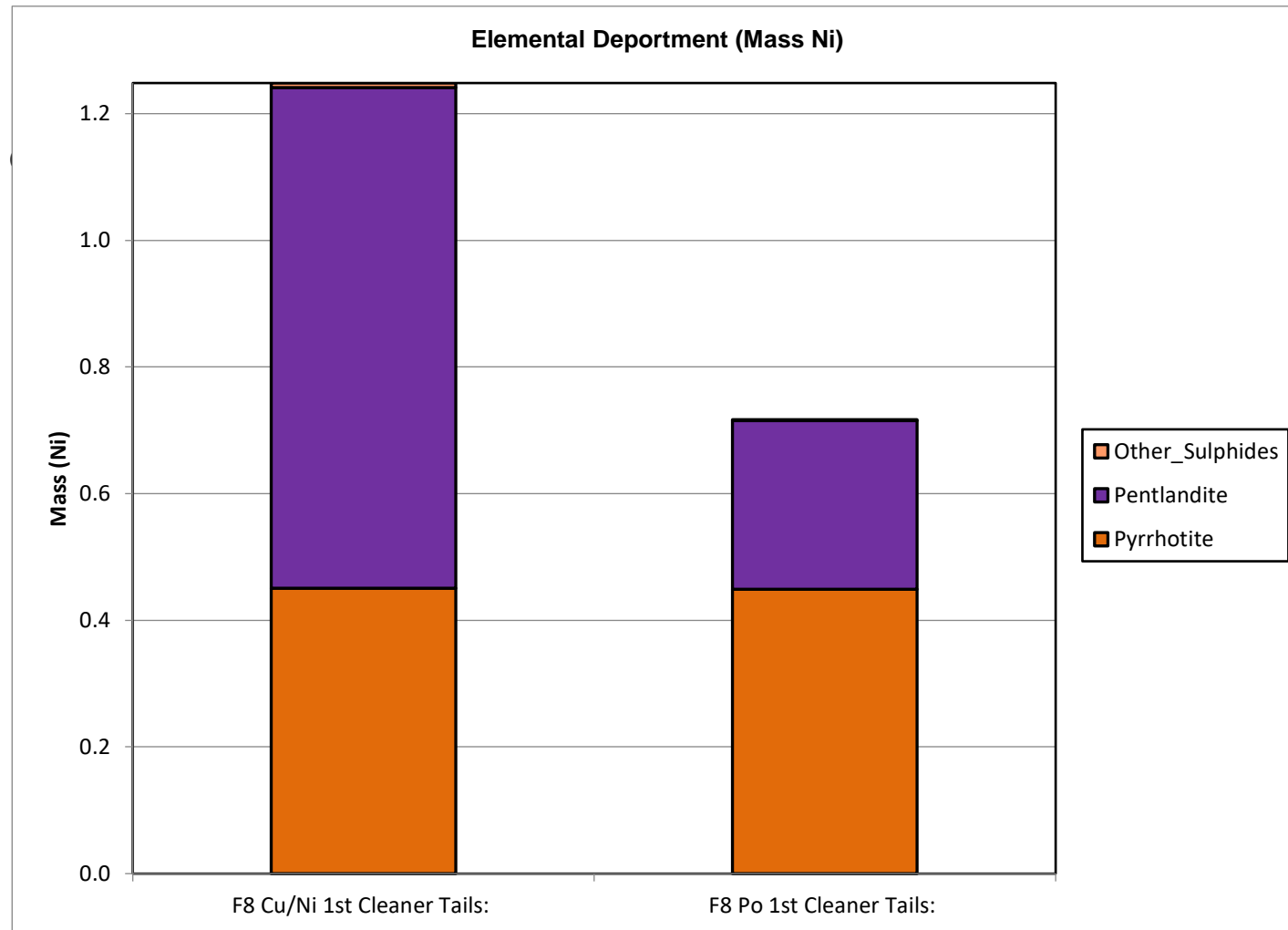

	F8 Cu/Ni 1st Cleaner Tails:	F8 Po 1st Cleaner Tails:
Pyrrhotite	0.45	0.45
Pentlandite	0.79	0.27
Other Sulphides	0.01	0.00
Total	1.25	0.72

Ni Department - Normalized

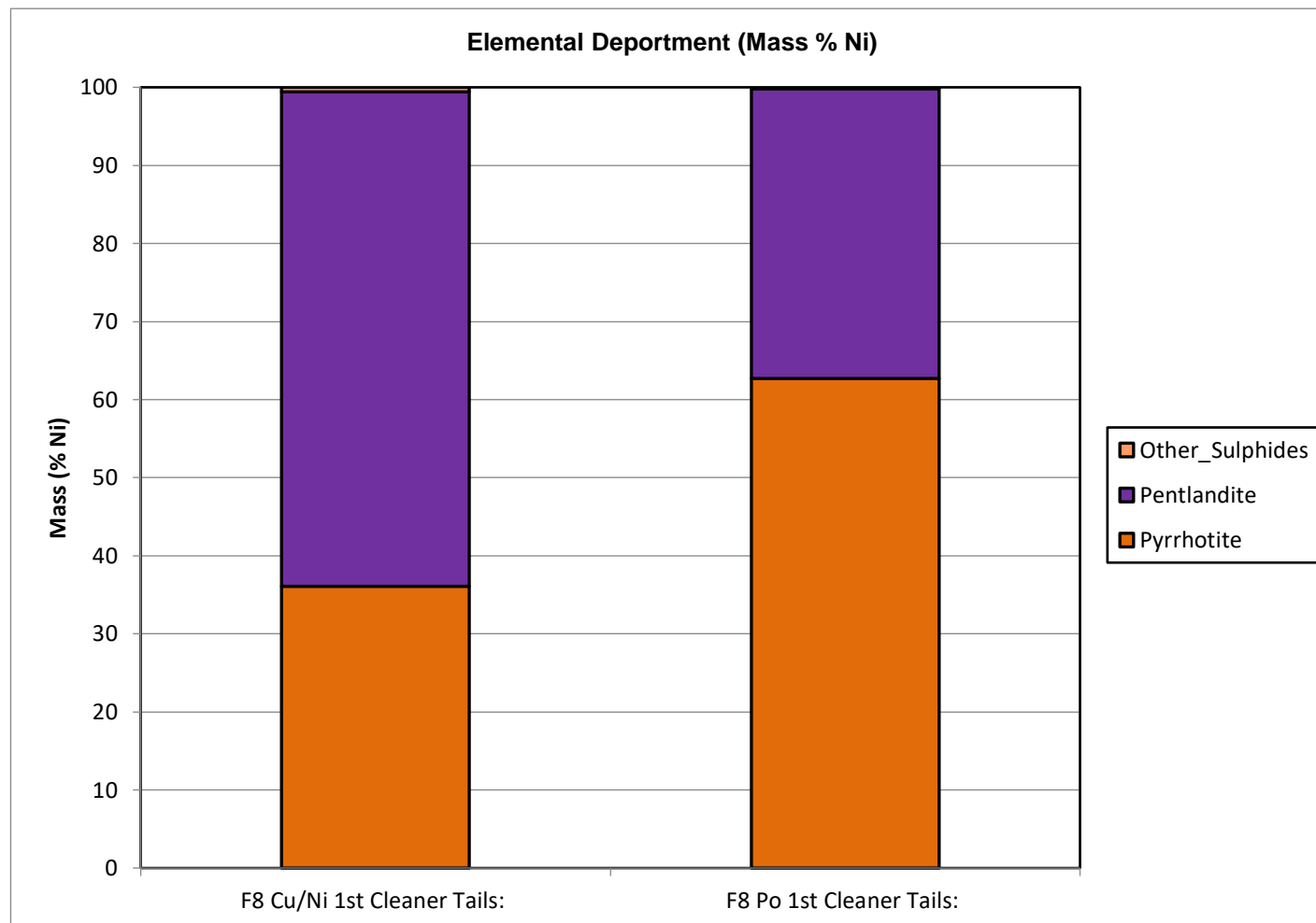

	F8 Cu/Ni 1st Cleaner Tails:	F8 Po 1st Cleaner Tails:
Pyrrhotite	36.09	62.69
Pentlandite	63.35	37.12
Other Sulphides	0.56	0.19
Total	100.00	100.00

North American Nickel
 18559-01
 MI5012-JUL21

High Definition Mineralogical Analysis using QEMSCAN (Quantitative Evaluation of Materials by Scanning Electron Microscopy)

Pentlandite Liberation

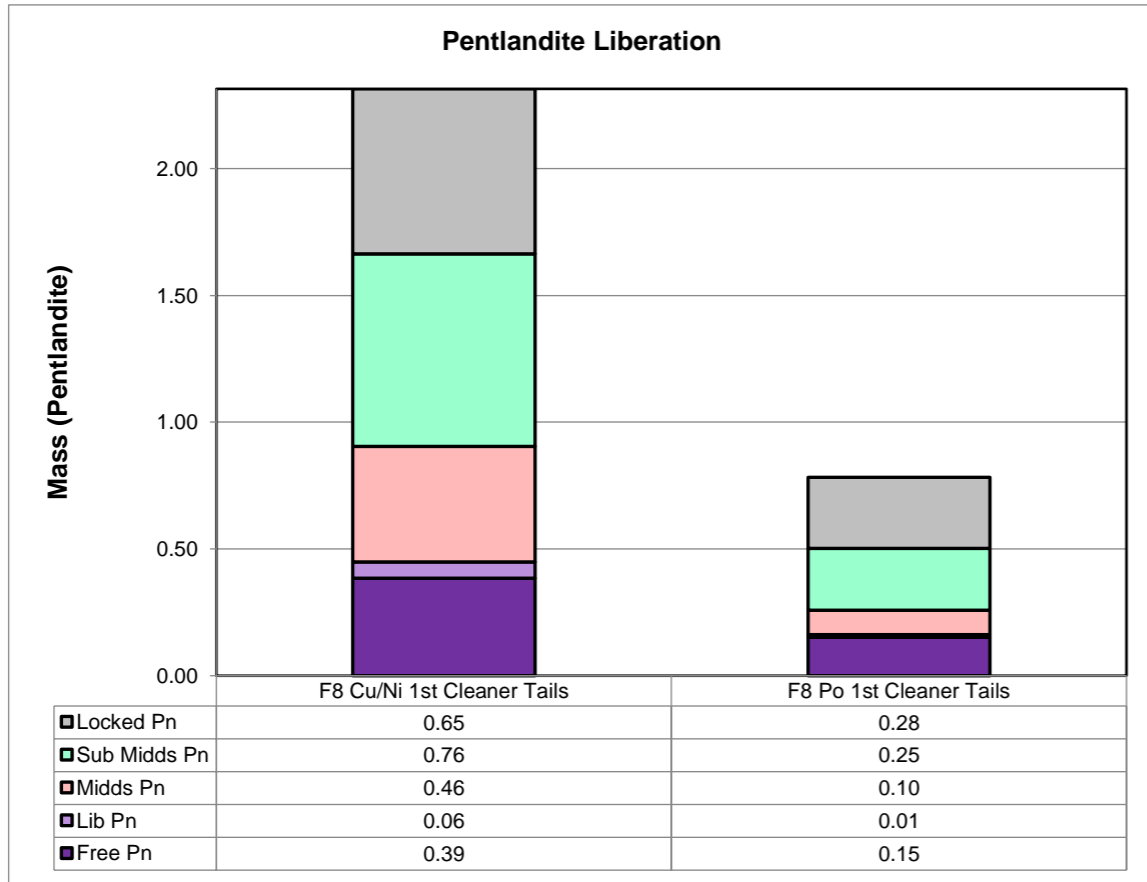

Absolute Mass of Pentlandite Across Samples

Mineral Name	F8 Cu/Ni 1st Cleaner Tails	F8 Po 1st Cleaner Tails
Free Pn	0.39	0.15
Lib Pn	0.06	0.01
Midds Pn	0.46	0.10
Sub Midds Pn	0.76	0.25
Locked Pn	0.65	0.28
Total	2.31	0.78

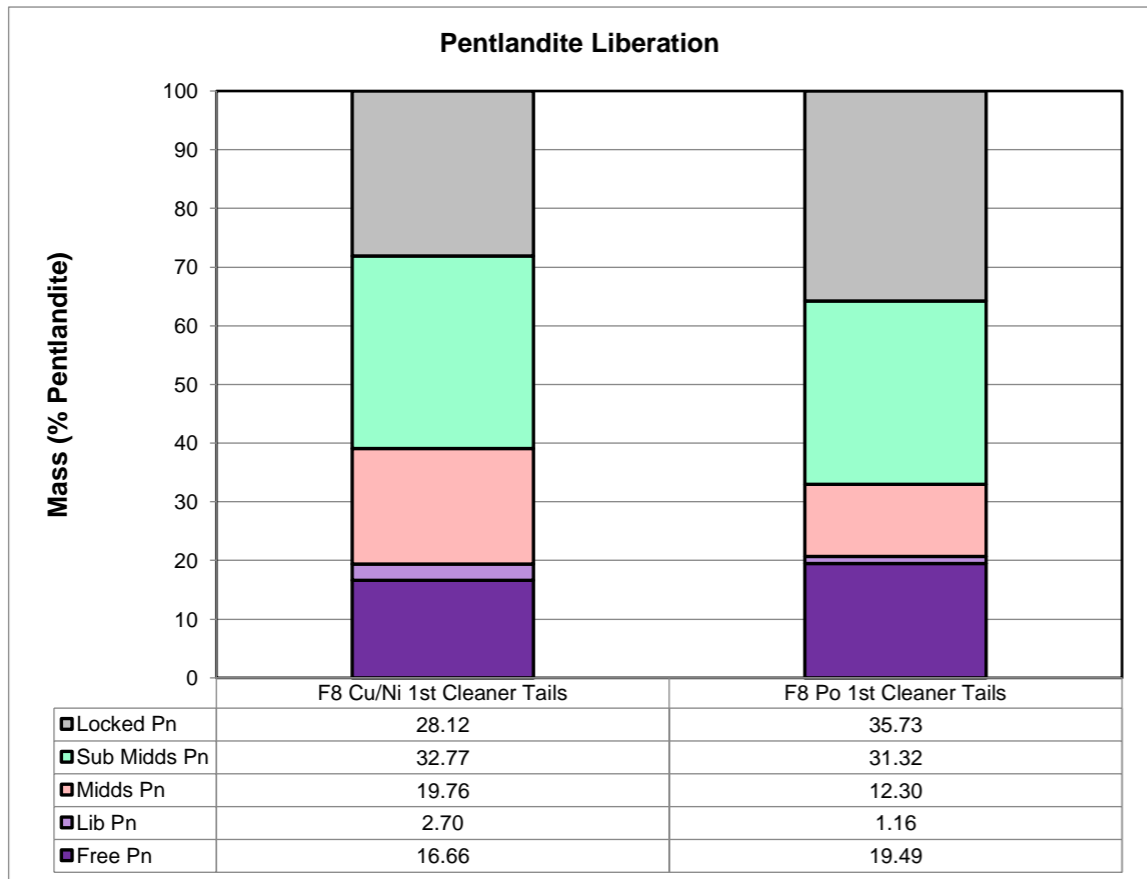

Normalized Mass of Pentlandite Across Samples

Mineral Name	F8 Cu/Ni 1st Cleaner Tails	F8 Po 1st Cleaner Tails
Free Pn	16.66	19.49
Lib Pn	2.70	1.16
Midds Pn	19.76	12.30
Sub Midds Pn	32.77	31.32
Locked Pn	28.12	35.73
Total	100.00	100.00

North American Nickel
18559-01
MI5012-JUL21

High Definition Mineralogical Analysis using QEMSCAN (Quantitative Evaluation of Materials by Scanning Electron Microscopy)

Pentlandite Association

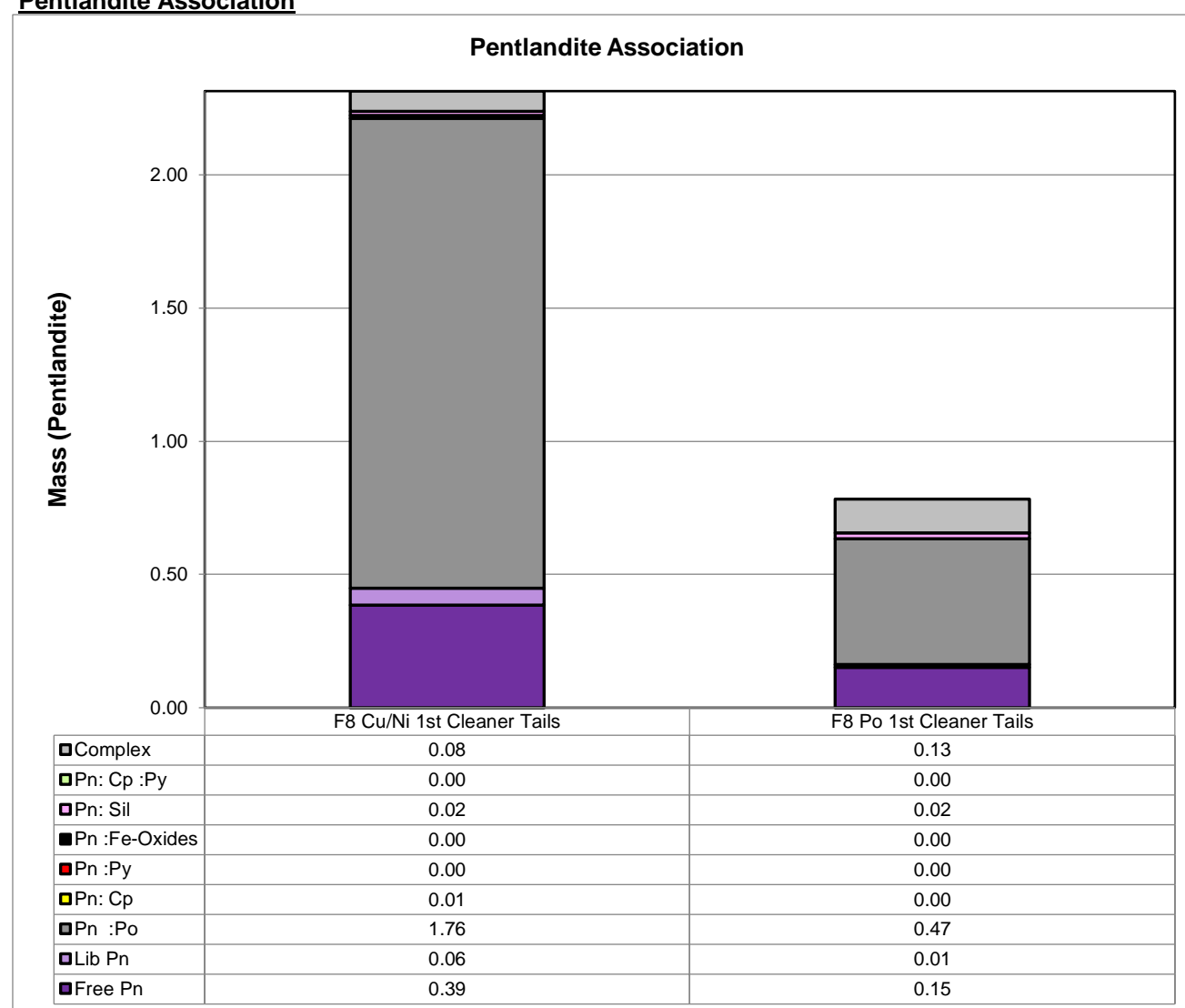

Absolute Mass of Pentlandite Across Samples

Mineral Name	F8 Cu/Ni 1st Cleaner Tails	F8 Po 1st Cleaner Tails
Free Pn	0.39	0.15
Lib Pn	0.06	0.01
Pn :Po	1.76	0.47
Pn: Cp	0.01	0.00
Pn :Py	0.00	0.00
Pn :Fe-Oxides	0.00	0.00
Pn: Sil	0.02	0.02
Pn: Cp :Py	0.00	0.00
Complex	0.08	0.13
Total	2.31	0.78

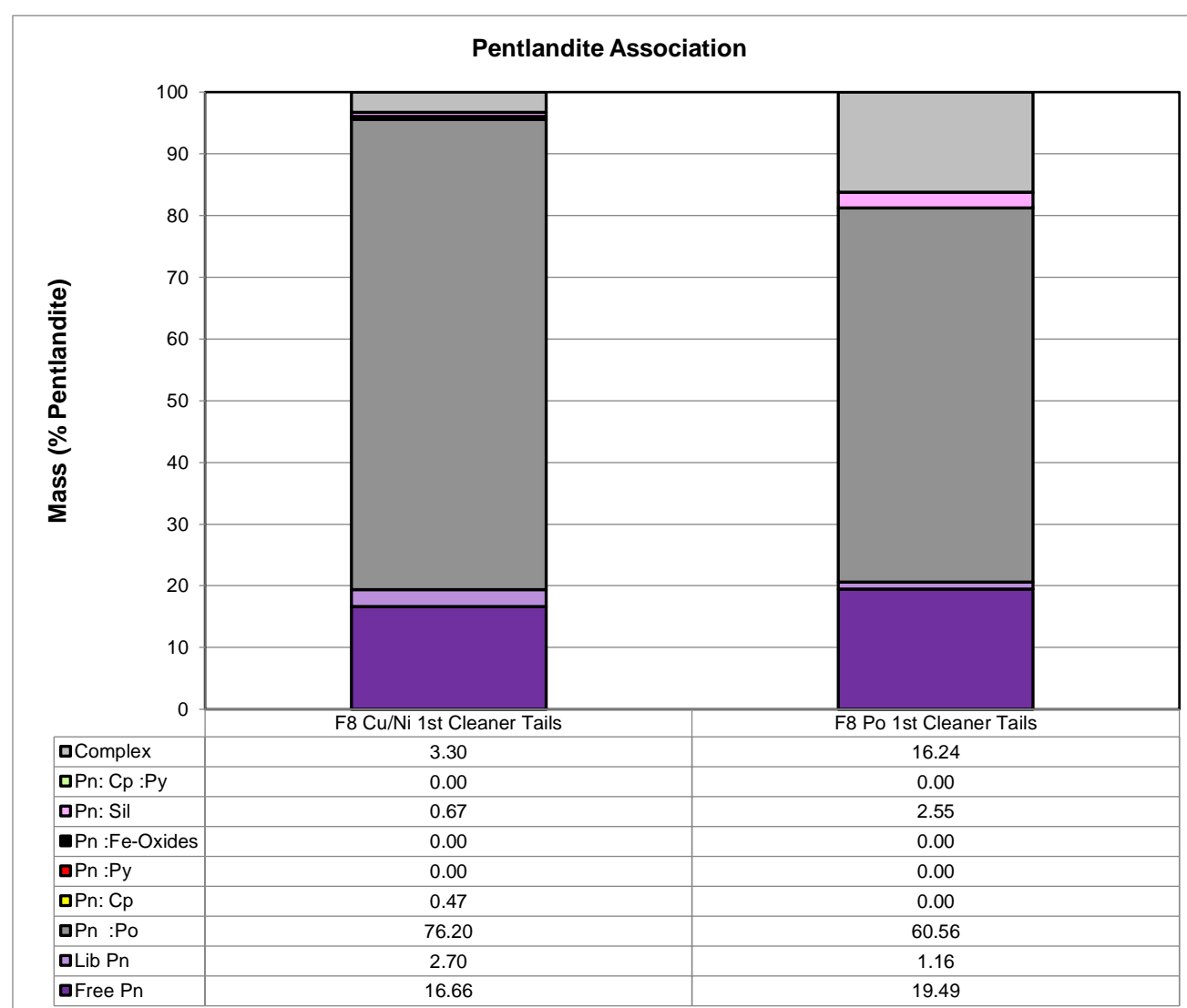

Normalized Mass of Pentlandite Across Samples

Mineral Name	F8 Cu/Ni 1st Cleaner Tails	F8 Po 1st Cleaner Tails
Free Pn	16.66	19.49
Lib Pn	2.70	1.16
Pn :Po	76.20	60.56
Pn: Cp	0.47	0.00
Pn :Py	0.00	0.00
Pn :Fe-Oxides	0.00	0.00
Pn: Sil	0.67	2.55
Pn: Cp :Py	0.00	0.00
Complex	3.30	16.24
Total	100.00	100.00

North American Nickel
18559-01
M15012-JUL21

High Definition Mineralogical Analysis using

Image Grid - Pentlandite Association

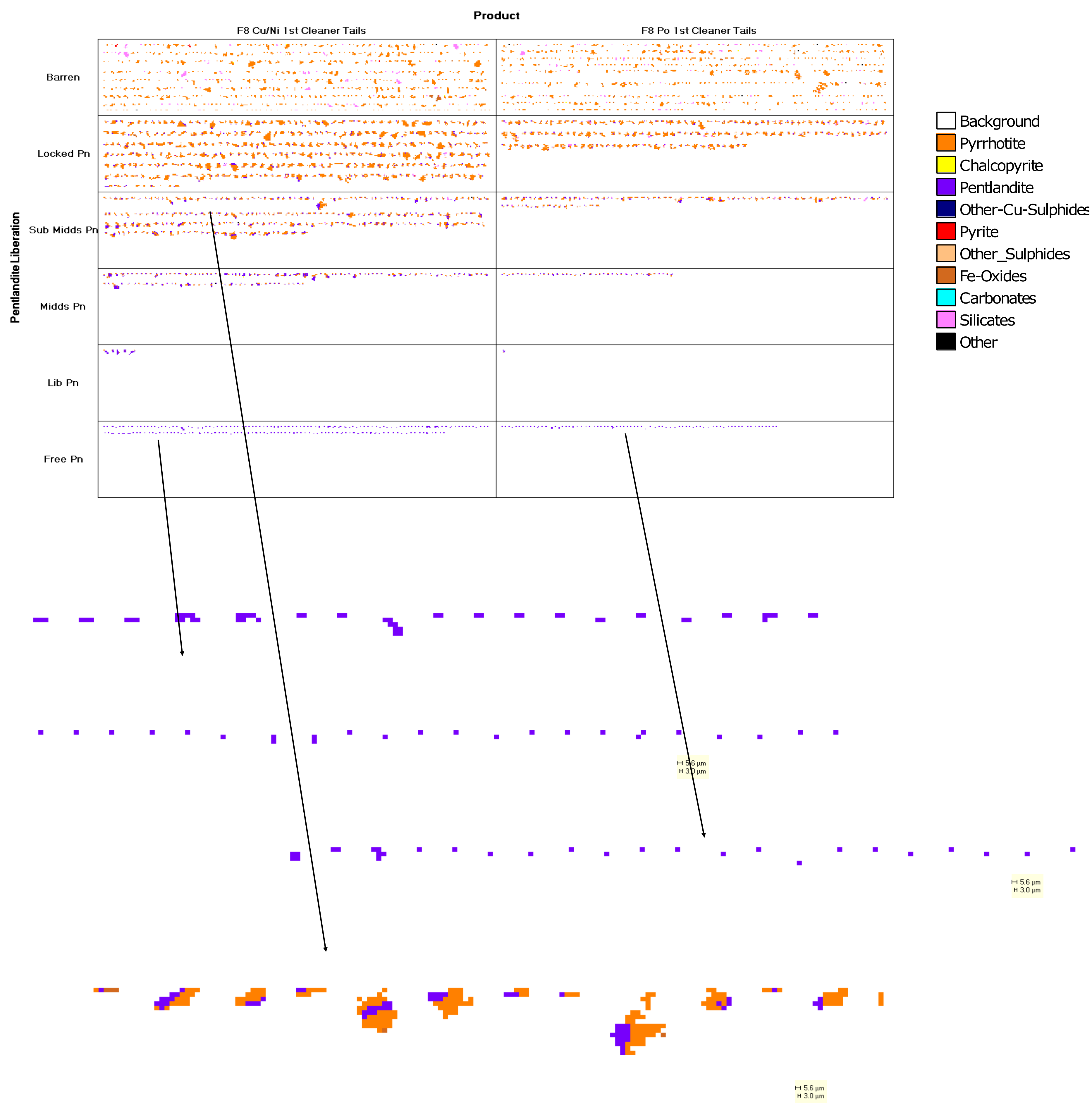

North American Nickel
18559-01
MI5012-JUL21

High Definition Mineralogical Analysis using QEMSCAN (Quantitative Evaluation of Materials by Scanning Electron Microscopy)

Pyrrhotite Liberation

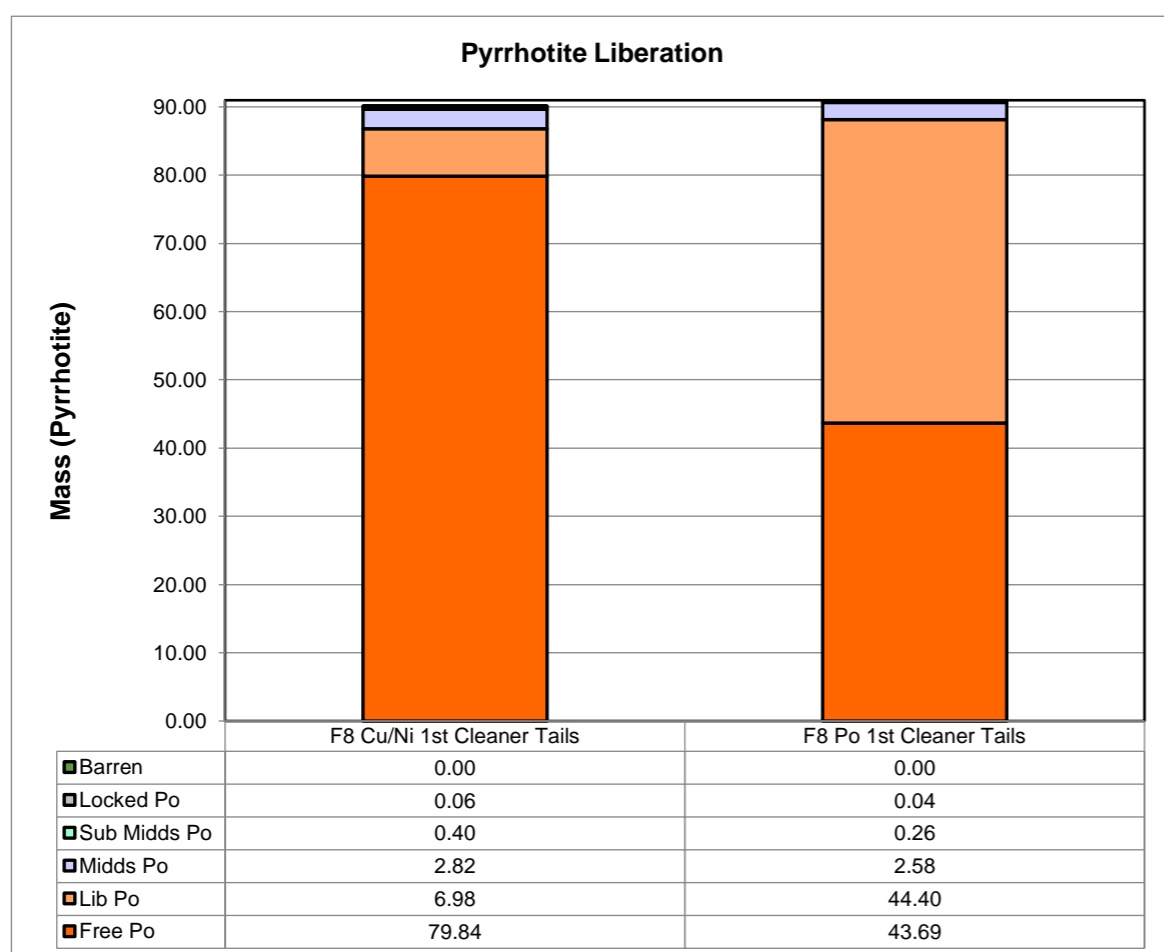

Absolute Mass of Pyrrhotite Across Samples

Mineral Name	F8 Cu/Ni 1st Cleaner Tails	F8 Po 1st Cleaner Tails
Free Po	79.84	43.69
Lib Po	6.98	44.40
Midds Po	2.82	2.58
Sub Midds Po	0.40	0.26
Locked Po	0.06	0.04
Barren	0.00	0.00
Total	90.10	90.97

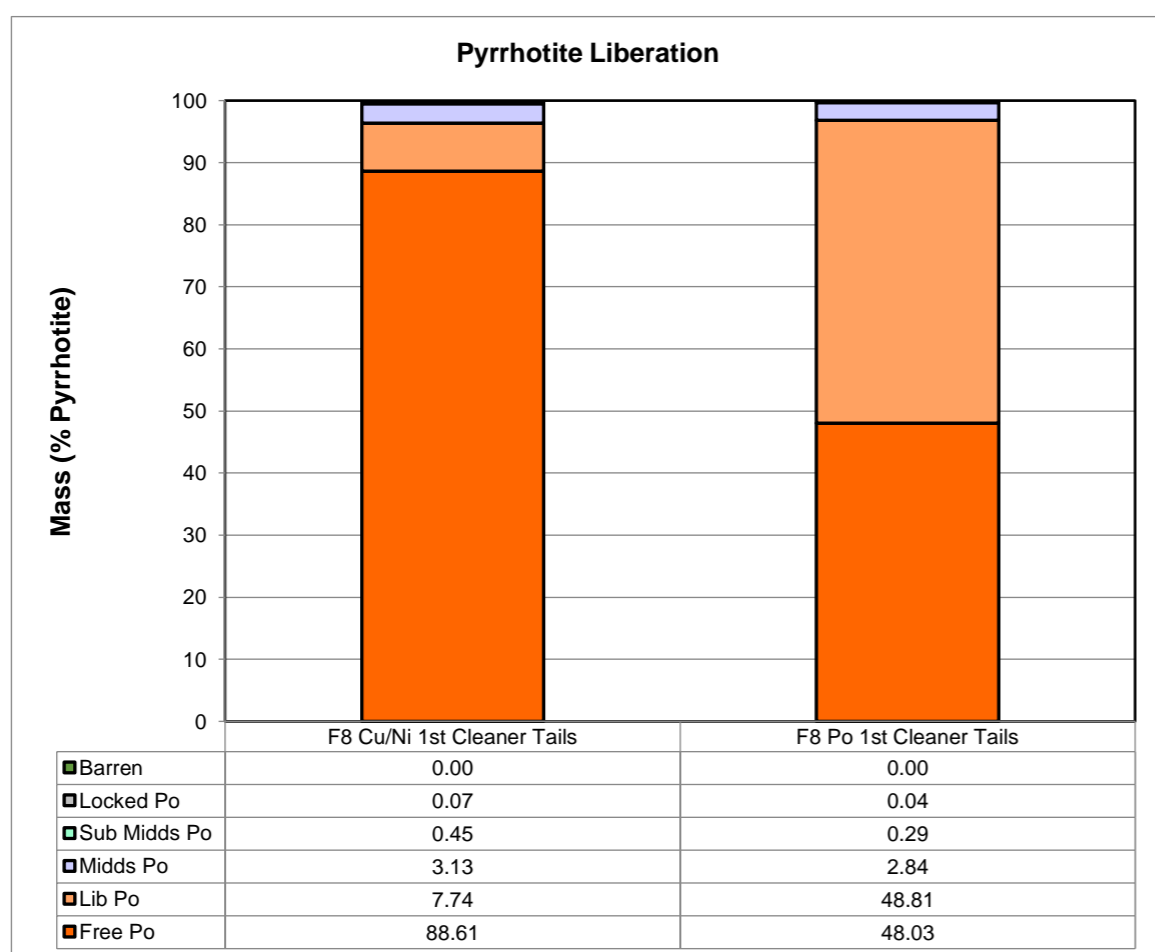

Normalized Mass of Pyrrhotite Across Samples

Mineral Name	F8 Cu/Ni 1st Cleaner Tails	F8 Po 1st Cleaner Tails
Free Po	88.61	48.03
Lib Po	7.74	48.81
Midds Po	3.13	2.84
Sub Midds Po	0.45	0.29
Locked Po	0.07	0.04
Barren	0.00	0.00
Total	100.00	100.00

North American Nickel
18559-01
MI5012-JUL21

High Definition Mineralogical Analysis using QEMSCAN (Quantitative Evaluation of Materials by Scanning Electron Microscopy)

Pyrrhotite Association

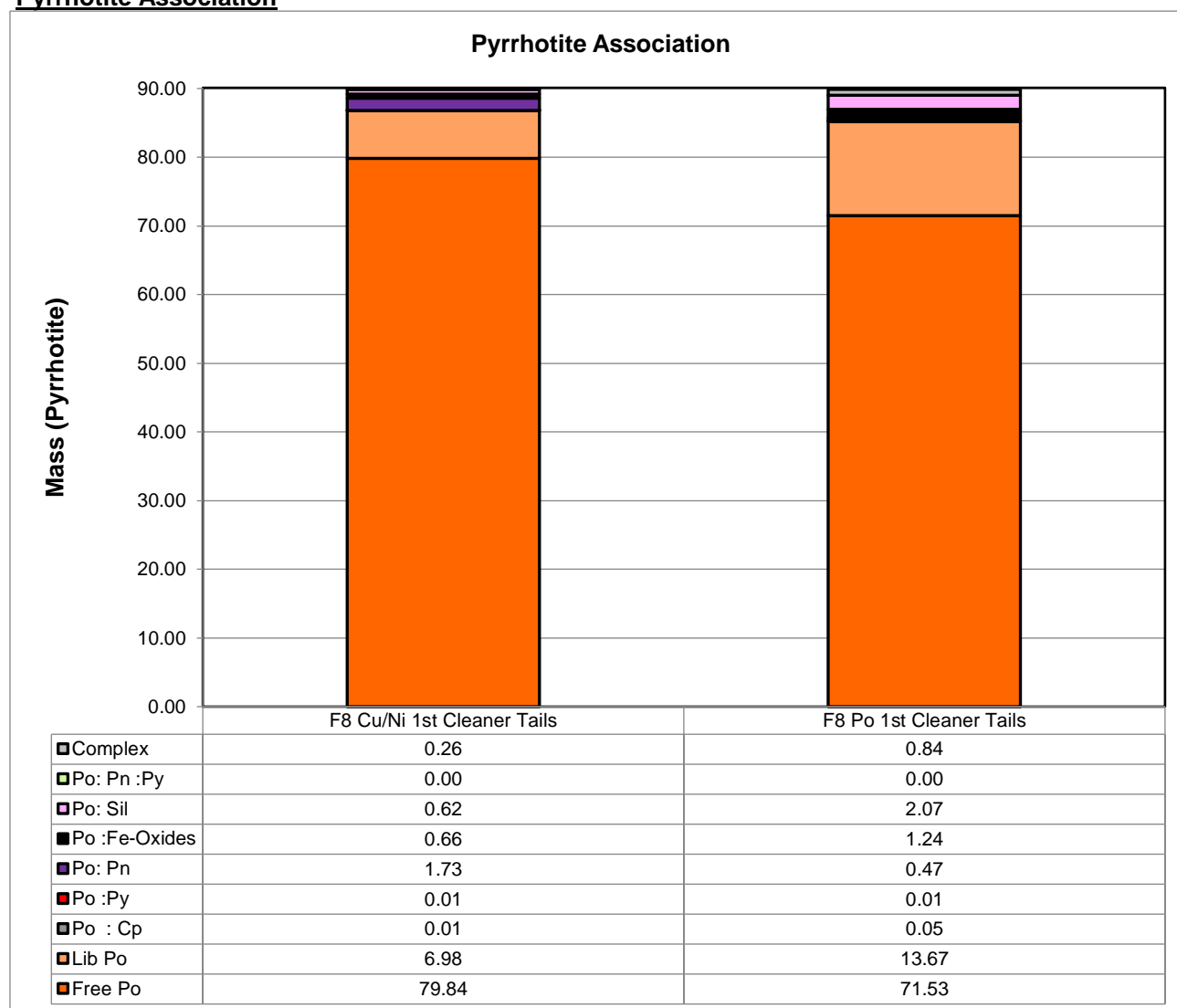

Absolute Mass of Pyrrhotite Across Samples

Mineral Name	F8 Cu/Ni 1st Cleaner Tails	F8 Po 1st Cleaner Tails
Free Po	79.84	71.53
Lib Po	6.98	13.67
Po : Cp	0.01	0.05
Po : Py	0.01	0.01
Po : Pn	1.73	0.47
Po : Fe-Oxides	0.66	1.24
Po : Sil	0.62	2.07
Po : Pn : Py	0.00	0.00
Complex	0.26	0.84
Total	90.10	89.88

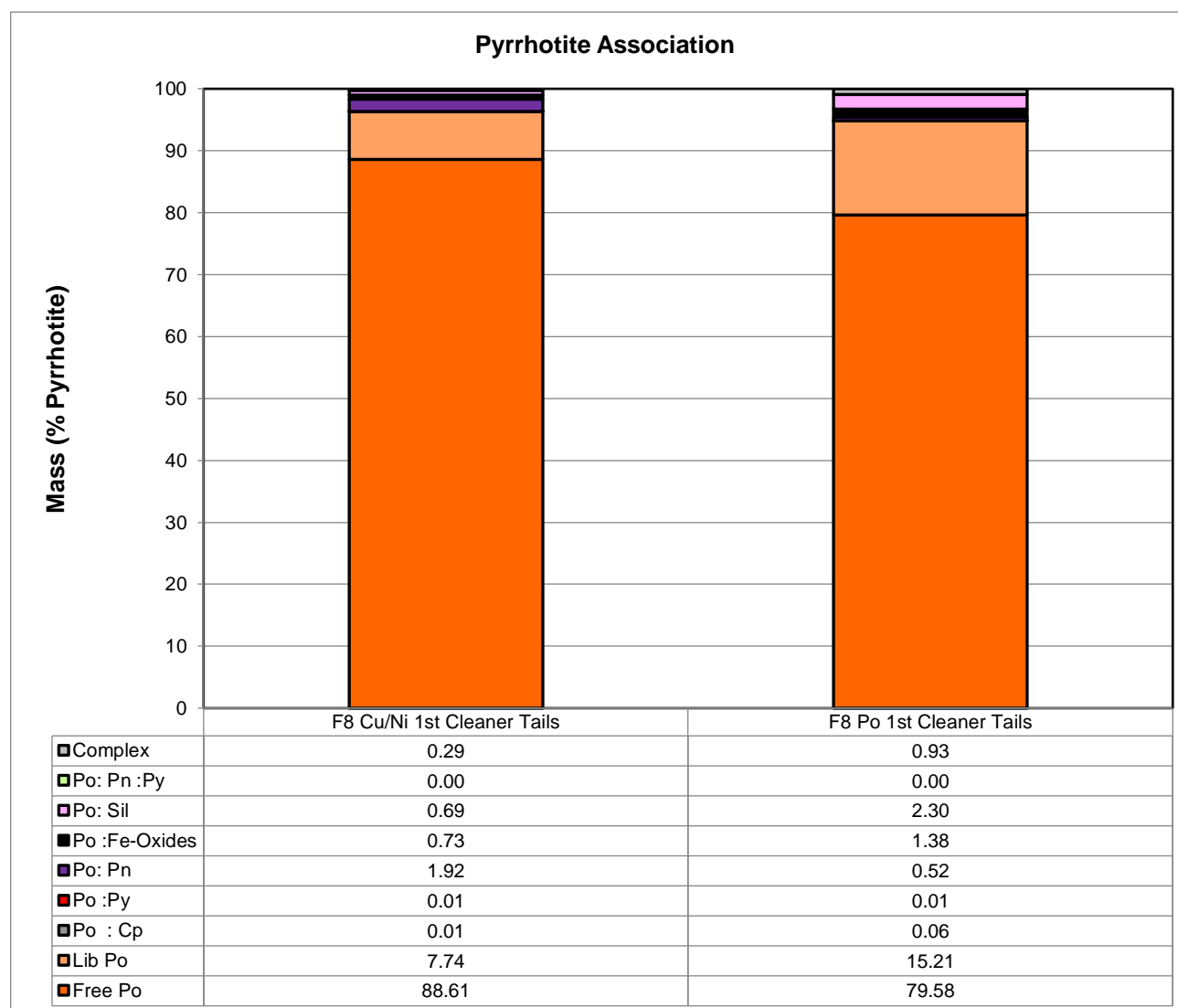

Normalized Mass of Pyrrhotite Across Samples

Mineral Name	F8 Cu/Ni 1st Cleaner Tails	F8 Po 1st Cleaner Tails
Free Po	88.61	79.58
Lib Po	7.74	15.21
Po : Cp	0.01	0.06
Po : Py	0.01	0.01
Po : Pn	1.92	0.52
Po : Fe-Oxides	0.73	1.38
Po : Sil	0.69	2.30
Po : Pn : Py	0.00	0.00
Complex	0.29	0.93
Total	100.00	100.00

North American Nickel
18559-01
MI5012-JUL21

High Definition Mineralogical Analysis using

Image Grid - Pyrrhotite Association



North American Nickel
 18559-01
 MI5012-JUL21

High Definition Mineralogical Analysis using QEMSCAN (Quantitative Evaluation of Materials by Scanning Electron Microscopy)

Chalcopyrite Liberation

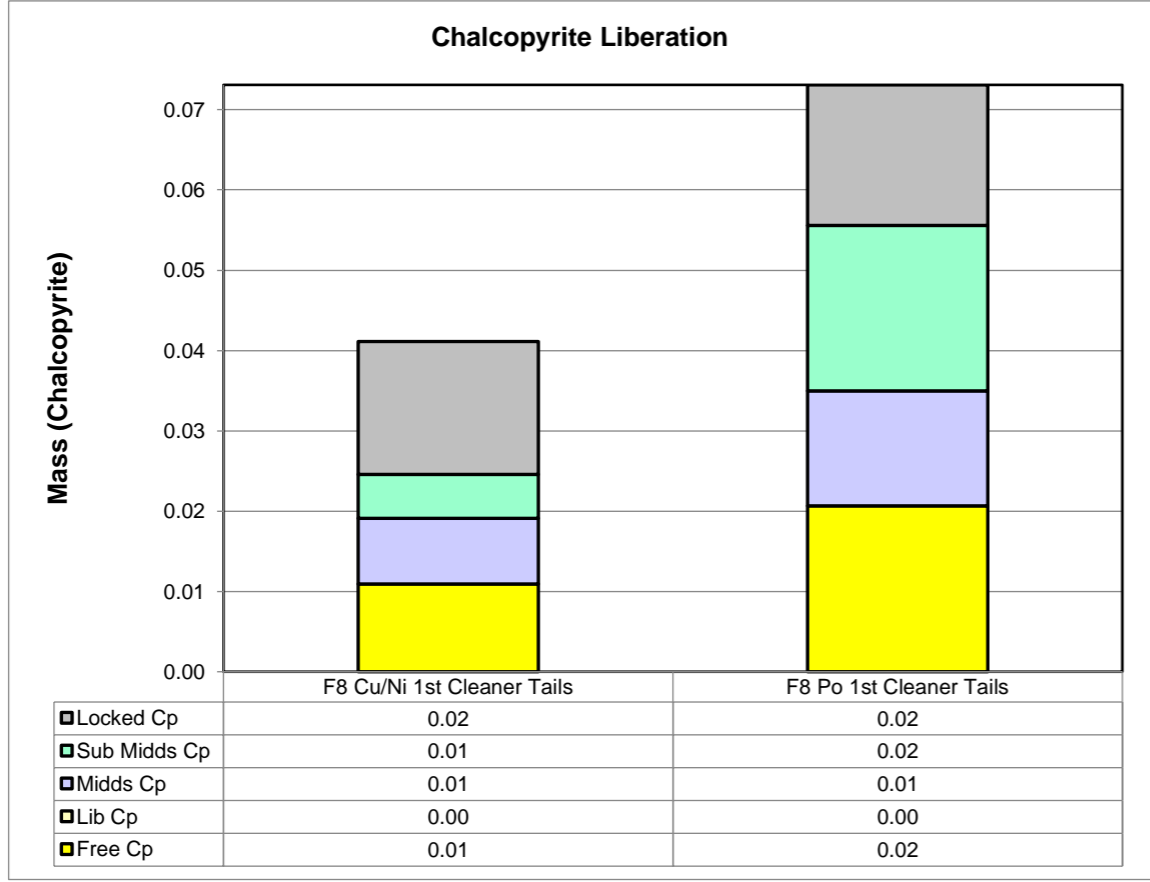

Absolute Mass of Chalcopyrite Across Samples

Mineral Name	F8 Cu/Ni 1st Cleaner Tails	F8 Po 1st Cleaner Tails
Free Cp	0.01	0.02
Lib Cp	0.00	0.00
Midds Cp	0.01	0.01
Sub Midds Cp	0.01	0.02
Locked Cp	0.02	0.02
Total	0.04	0.07

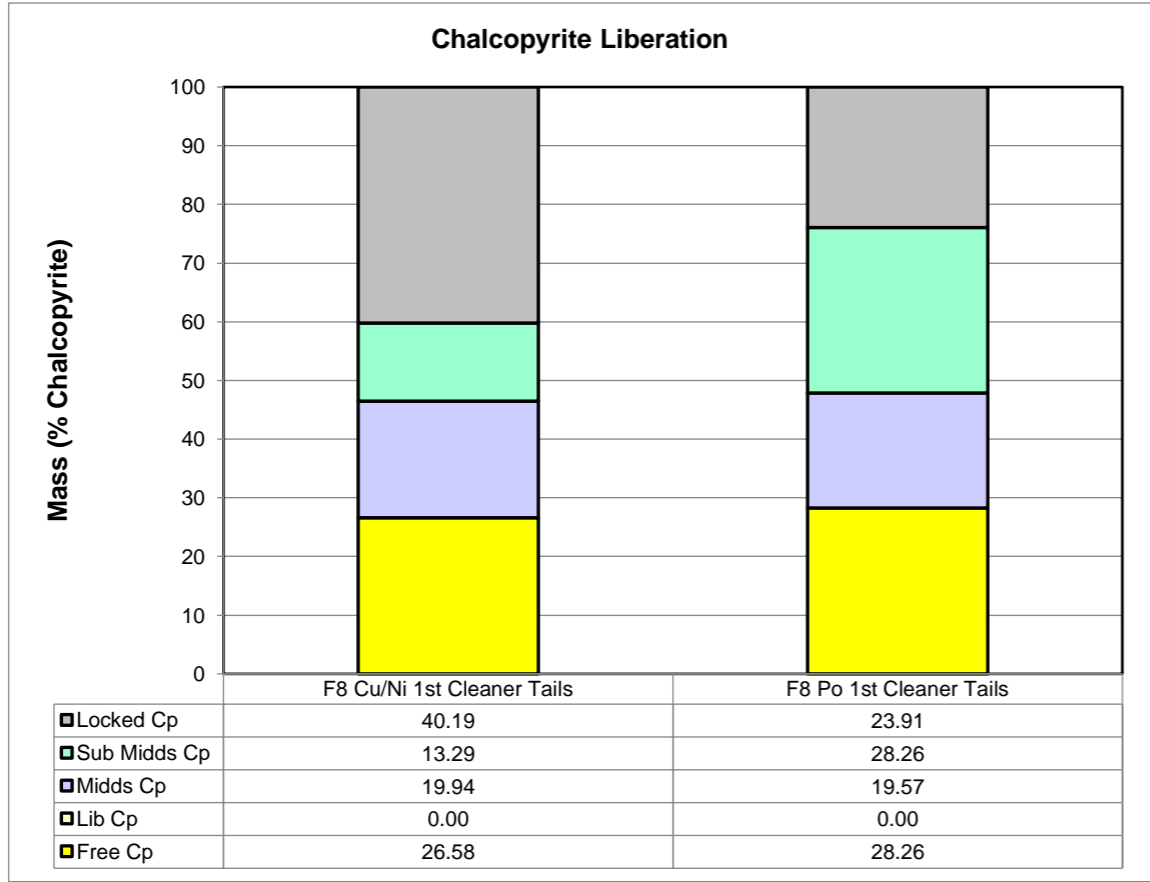

Normalized Mass of Chalcopyrite Across Samples

Mineral Name	F8 Cu/Ni 1st Cleaner Tails	F8 Po 1st Cleaner Tails
Free Cp	26.58	28.26
Lib Cp	0.00	0.00
Midds Cp	19.94	19.57
Sub Midds Cp	13.29	28.26
Locked Cp	40.19	23.91
Total	100.00	100.00

North American Nickel
18559-01
MI5012-JUL21

High Definition Mineralogical Analysis using QEMSCAN (Quantitative Evaluation of Materials by Scanning Electron Microscopy)

Chalcopyrite Association

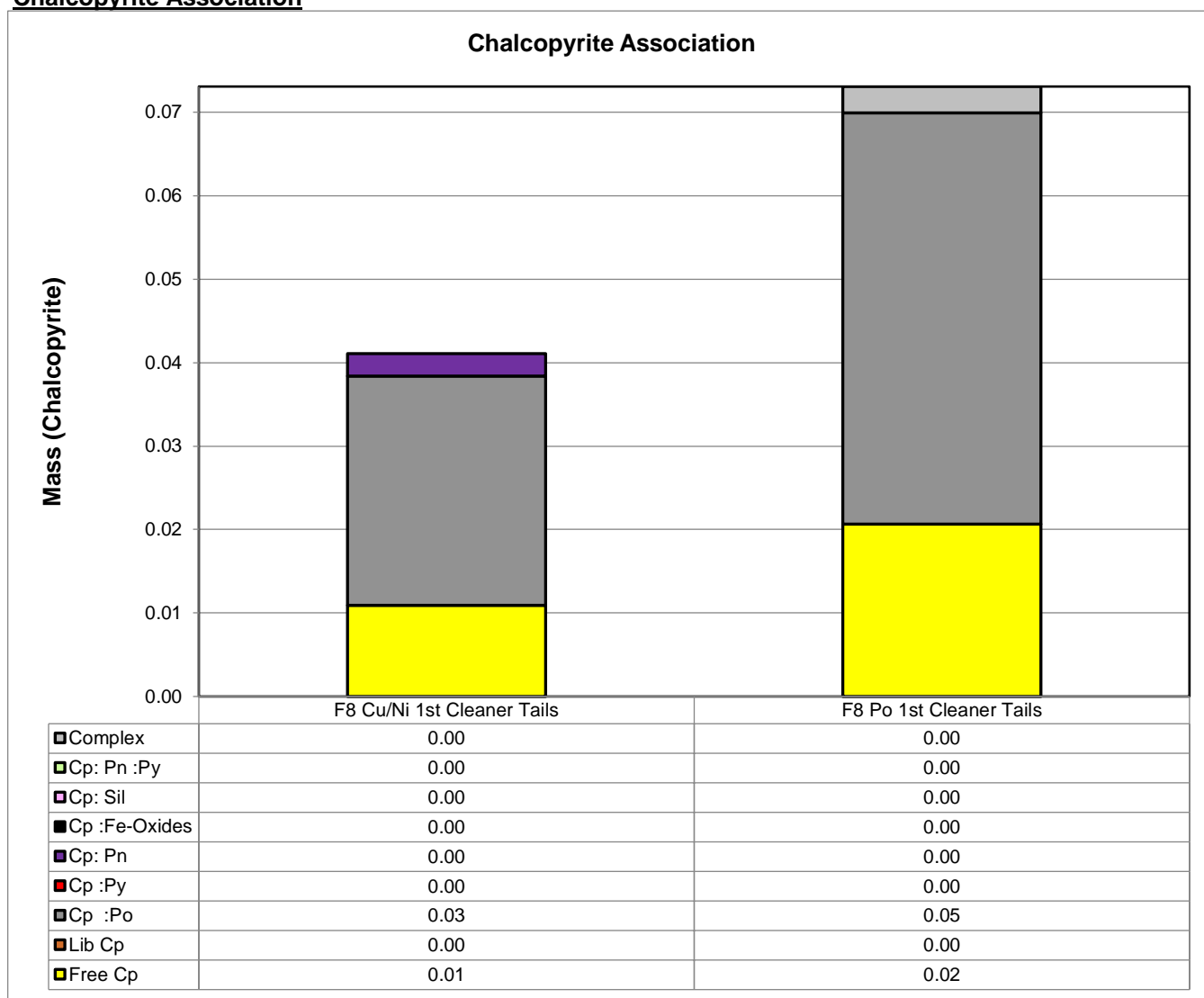

Absolute Mass of Chalcopyrite Across Samples

Mineral Name	F8 Cu/Ni 1st Cleaner Tails	F8 Po 1st Cleaner Tails
Free Cp	0.01	0.02
Lib Cp	0.00	0.00
Cp :Po	0.03	0.05
Cp :Py	0.00	0.00
Cp: Pn	0.00	0.00
Cp :Fe-Oxides	0.00	0.00
Cp: Sil	0.00	0.00
Cp: Pn :Py	0.00	0.00
Complex	0.00	0.00
Total	0.04	0.07

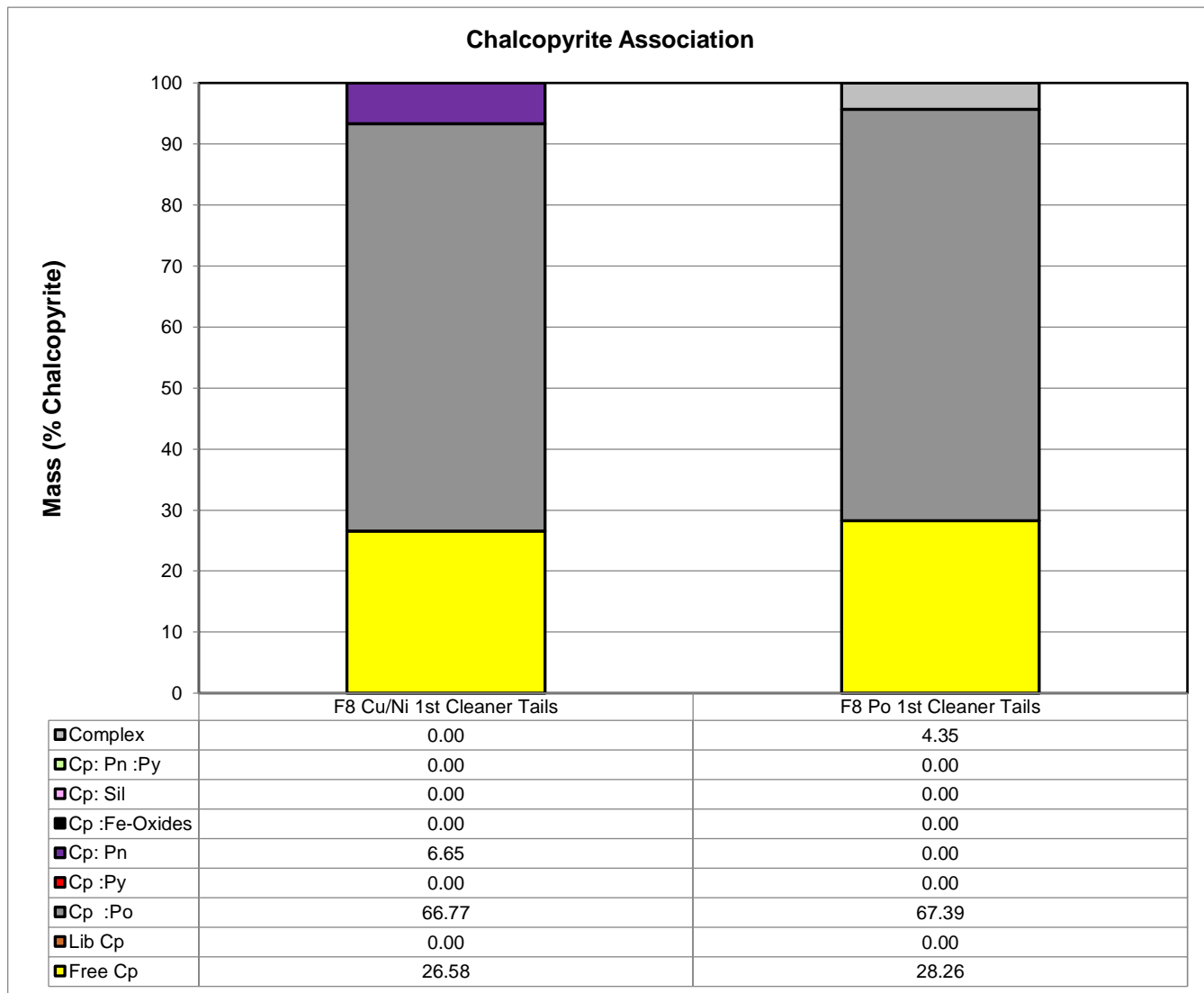

Normalized Mass of Chalcopyrite Across Samples

Mineral Name	F8 Cu/Ni 1st Cleaner Tails	F8 Po 1st Cleaner Tails
Free Cp	26.58	28.26
Lib Cp	0.00	0.00
Cp :Po	66.77	67.39
Cp :Py	0.00	0.00
Cp: Pn	6.65	0.00
Cp :Fe-Oxides	0.00	0.00
Cp: Sil	0.00	0.00
Cp: Pn :Py	0.00	0.00
Complex	0.00	4.35
Total	100.00	100.00

North American Nickel
 18559-01
 MI5012-JUL21

High Definition Mineralogical Analysis using

Image Grid - Chalcopyrite Association

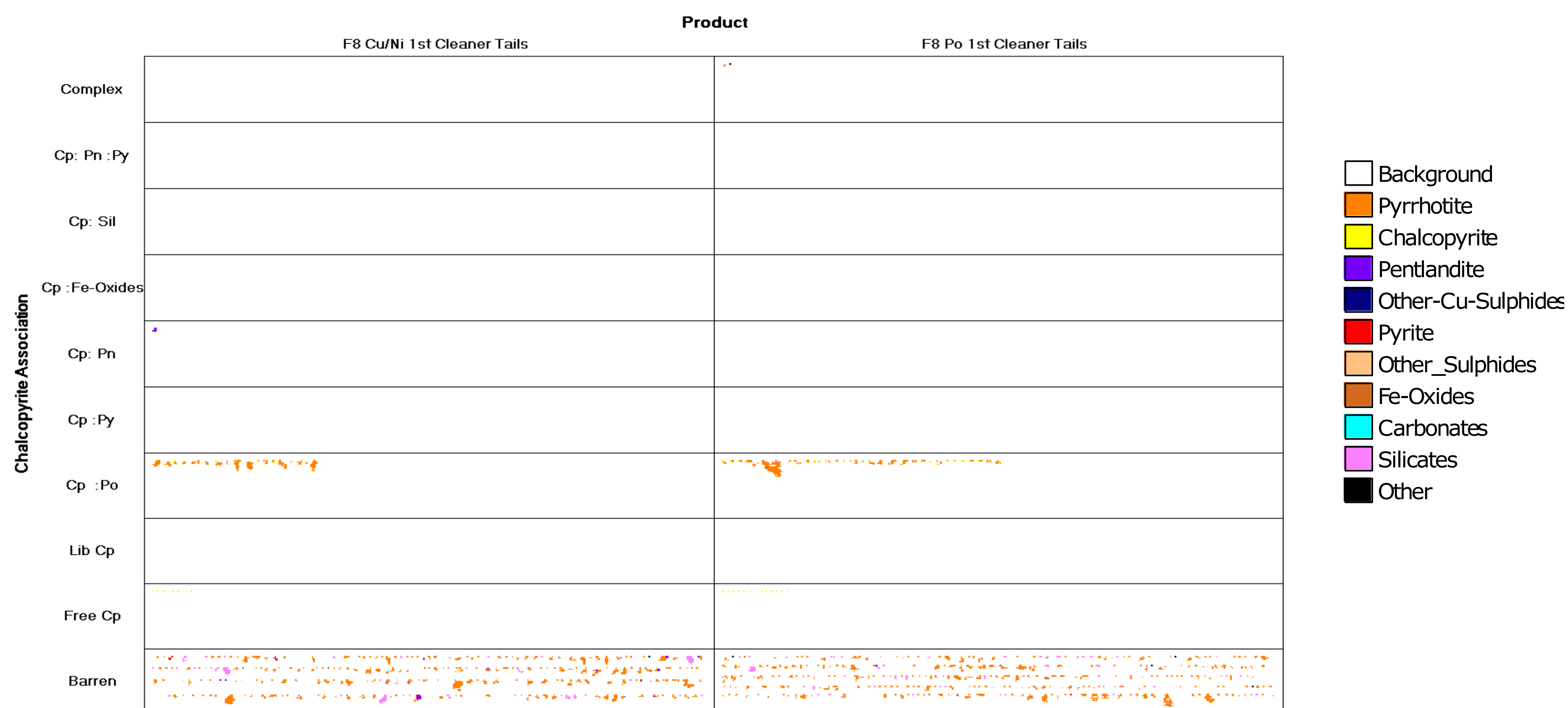

- Background
- Pyrrhotite
- Chalcopyrite
- Pentlandite
- Other-Cu-Sulphides
- Pyrite
- Other_Sulphides
- Fe-Oxides
- Carbonates
- Silicates
- Other

North American Nickel
 18559-01
 MI5012-JUL21

High Definition Mineralogical Analysis using QEMSCAN (Quantitative Evaluation of Materials by Scanning Electron Microscopy)

Pyrite Liberation

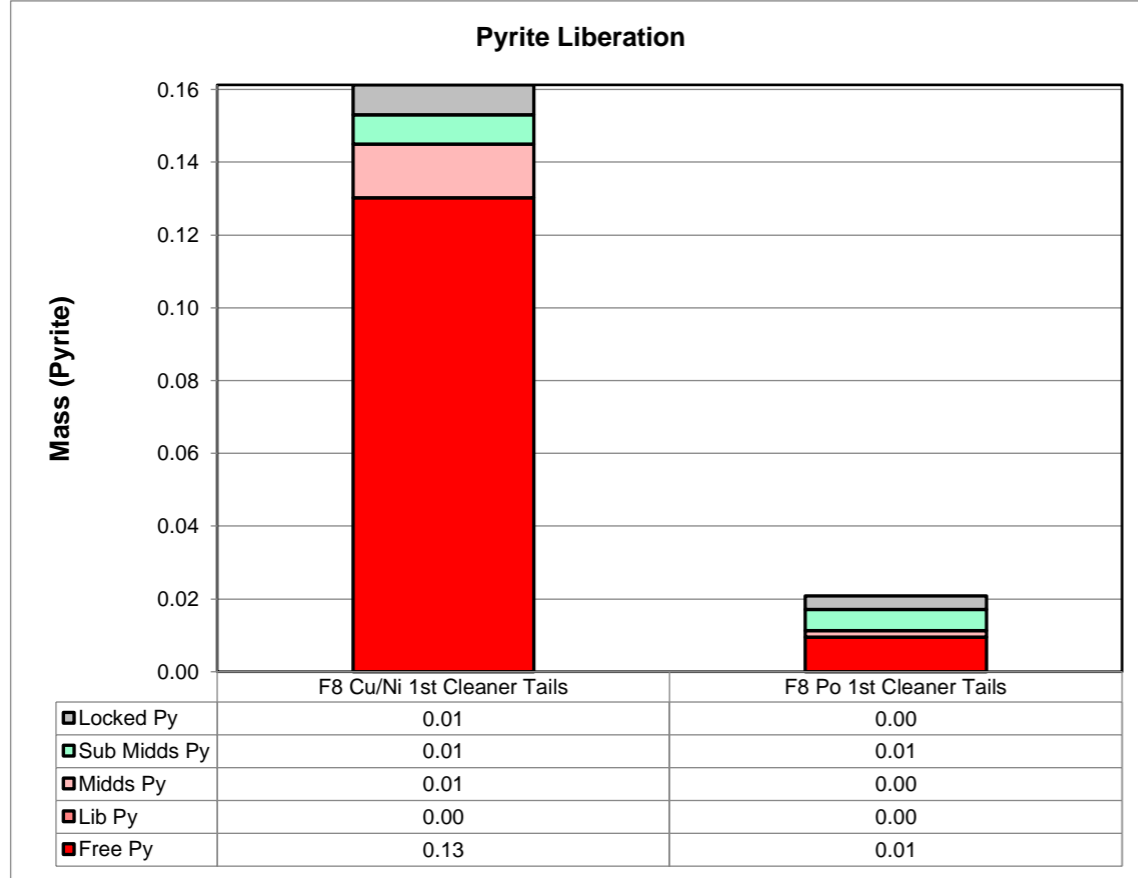

Absolute Mass of Pyrite Across Samples

Mineral Name	F8 Cu/Ni 1st Cleaner Tails	F8 Po 1st Cleaner Tails
Free Py	0.13	0.01
Lib Py	0.00	0.00
Mids Py	0.01	0.00
Sub Mids Py	0.01	0.01
Locked Py	0.01	0.00
Total	0.16	0.02

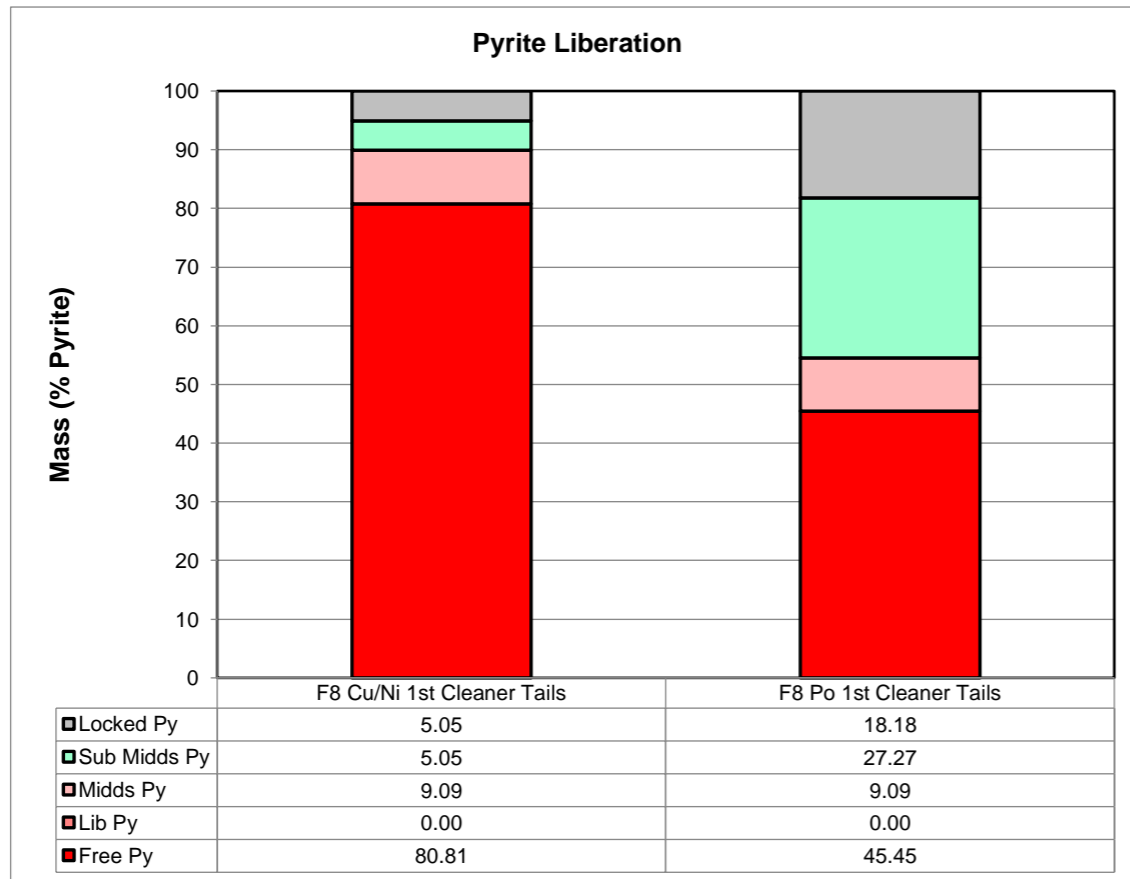

Normalized Mass of Pyrite Across Samples

Mineral Name	F8 Cu/Ni 1st Cleaner Tails	F8 Po 1st Cleaner Tails
Free Py	80.81	45.45
Lib Py	0.00	0.00
Mids Py	9.09	9.09
Sub Mids Py	5.05	27.27
Locked Py	5.05	18.18
Total	100.00	100.00

North American Nickel
18559-01
MI5012-JUL21

High Definition Mineralogical Analysis using QEMSCAN (Quantitative Evaluation of Materials by Scanning Electron Microscopy)

Pyrite Association

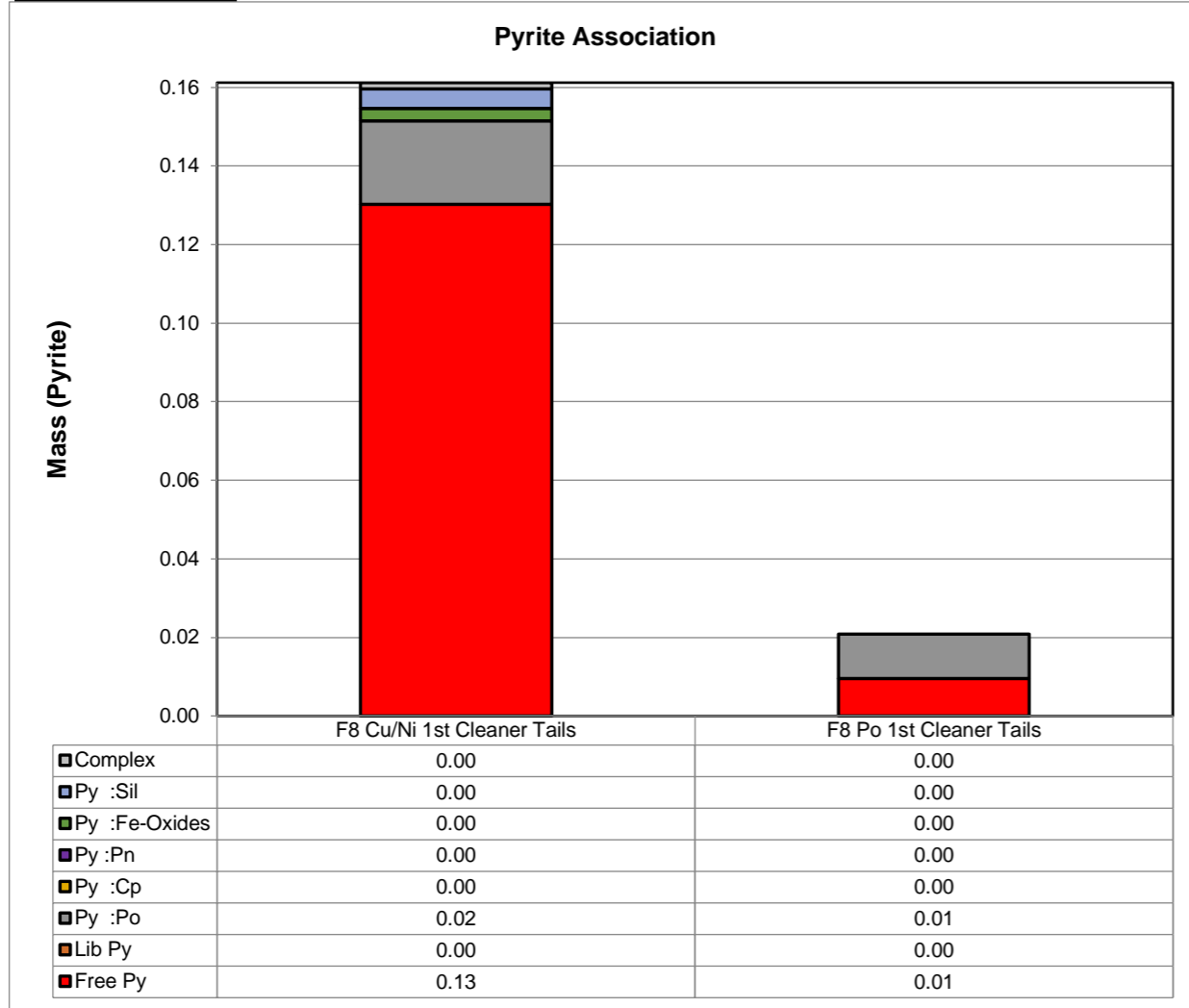

Absolute Mass of Pyrite Across Samples

Mineral Name	F8 Cu/Ni 1st Cleaner Tails	F8 Po 1st Cleaner Tails
Free Py	0.13	0.01
Lib Py	0.00	0.00
Py :Po	0.02	0.01
Py :Cp	0.00	0.00
Py :Pn	0.00	0.00
Py :Fe-Oxides	0.00	0.00
Py :Sil	0.00	0.00
Complex	0.00	0.00
Total	0.16	0.02

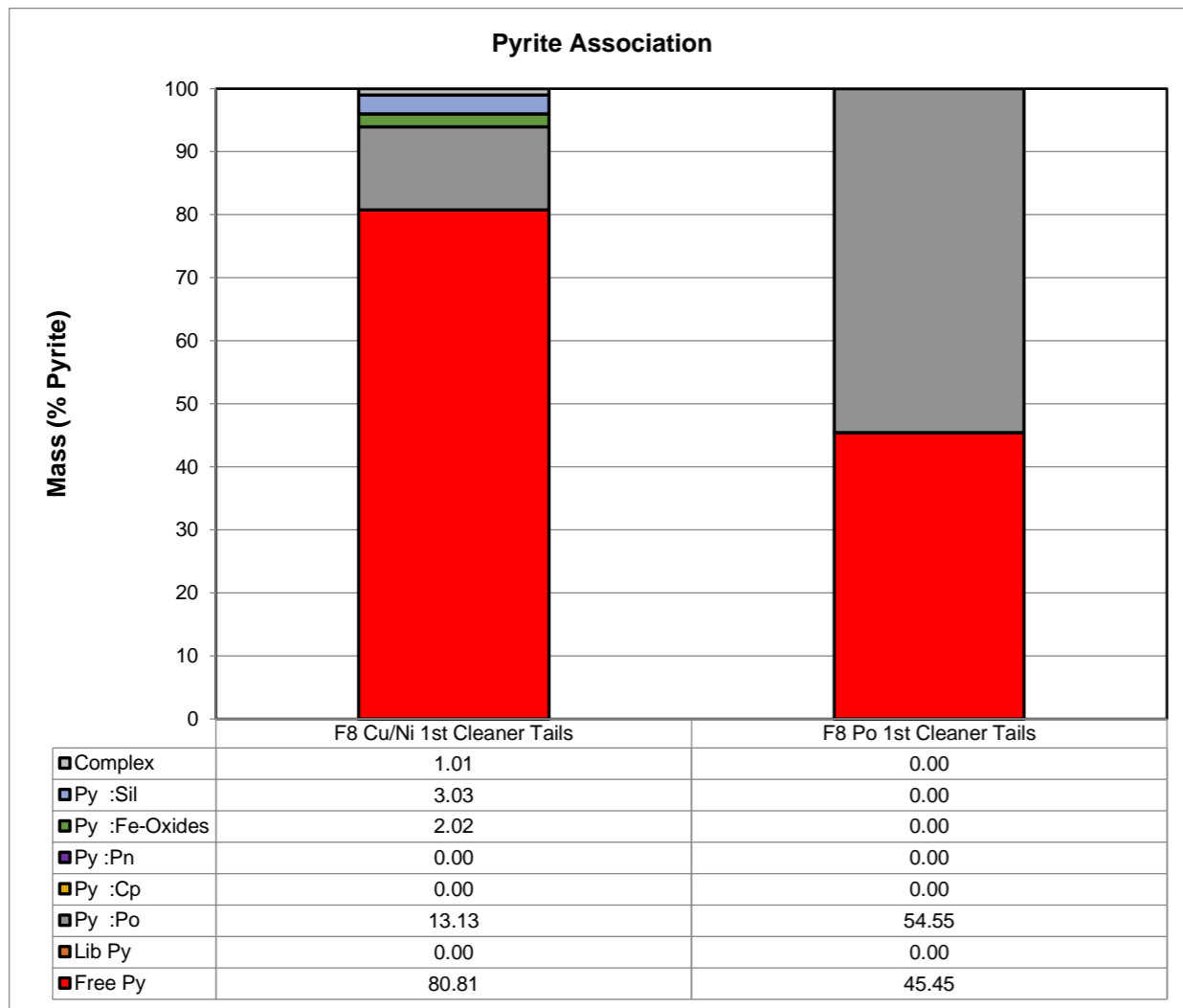

Normalized Mass of Pyrite Across Samples

Mineral Name	F8 Cu/Ni 1st Cleaner Tails	F8 Po 1st Cleaner Tails
Free Py	80.81	45.45
Lib Py	0.00	0.00
Py :Po	13.13	54.55
Py :Cp	0.00	0.00
Py :Pn	0.00	0.00
Py :Fe-Oxides	2.02	0.00
Py :Sil	3.03	0.00
Complex	1.01	0.00
Total	100.00	100.00

North American Nickel
 18559-01
 MI5012-JUL21

High Definition Mineralogical Analysis using QEMSCAN (Quantitative Evaluation of Materials by Scanning Electron Microscopy)

Silicates Liberation

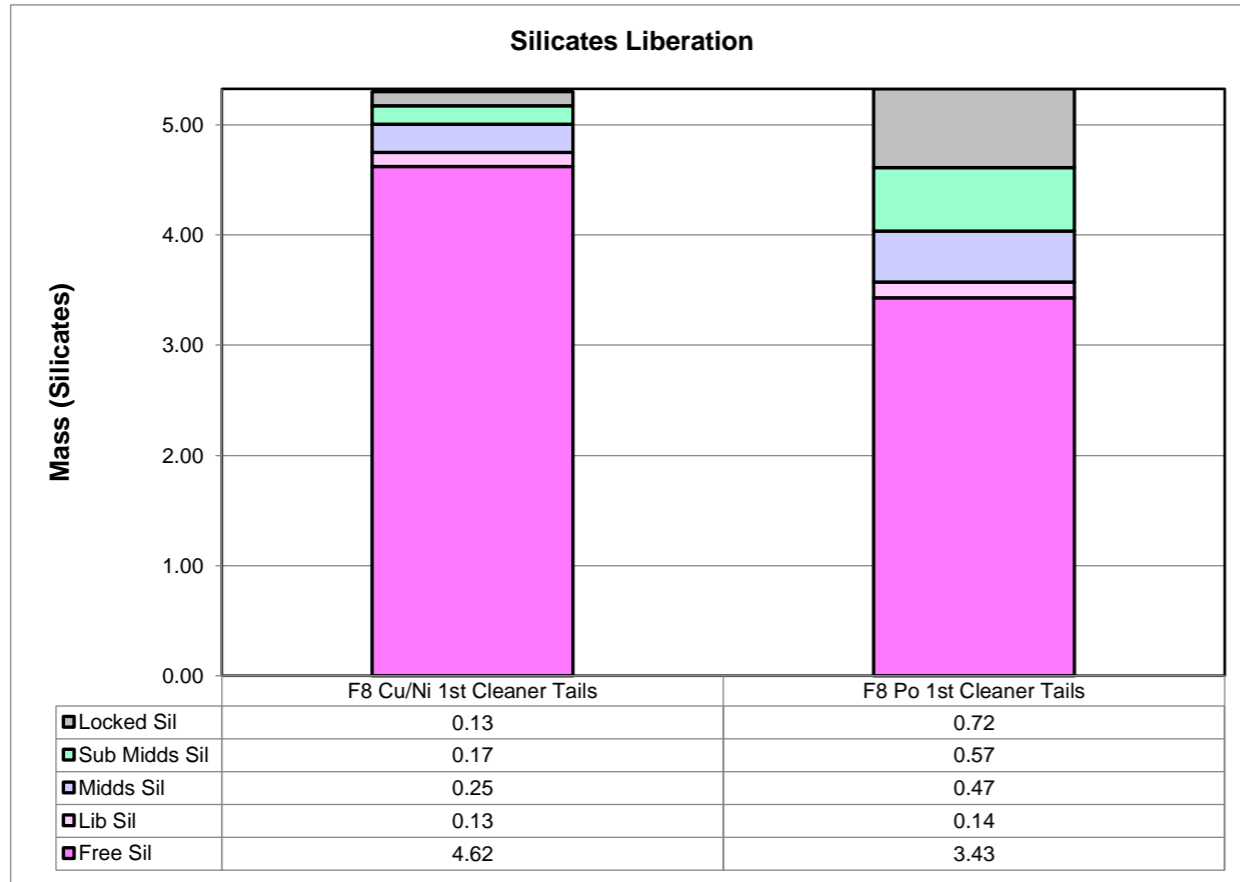

Absolute Mass of Silicates Across Samples

Mineral Name	F8 Cu/Ni 1st Cleaner Tails	F8 Po 1st Cleaner Tails
Free Sil	4.62	3.43
Lib Sil	0.13	0.14
Midds Sil	0.25	0.47
Sub Midds Sil	0.17	0.57
Locked Sil	0.13	0.72
Total	5.30	5.33

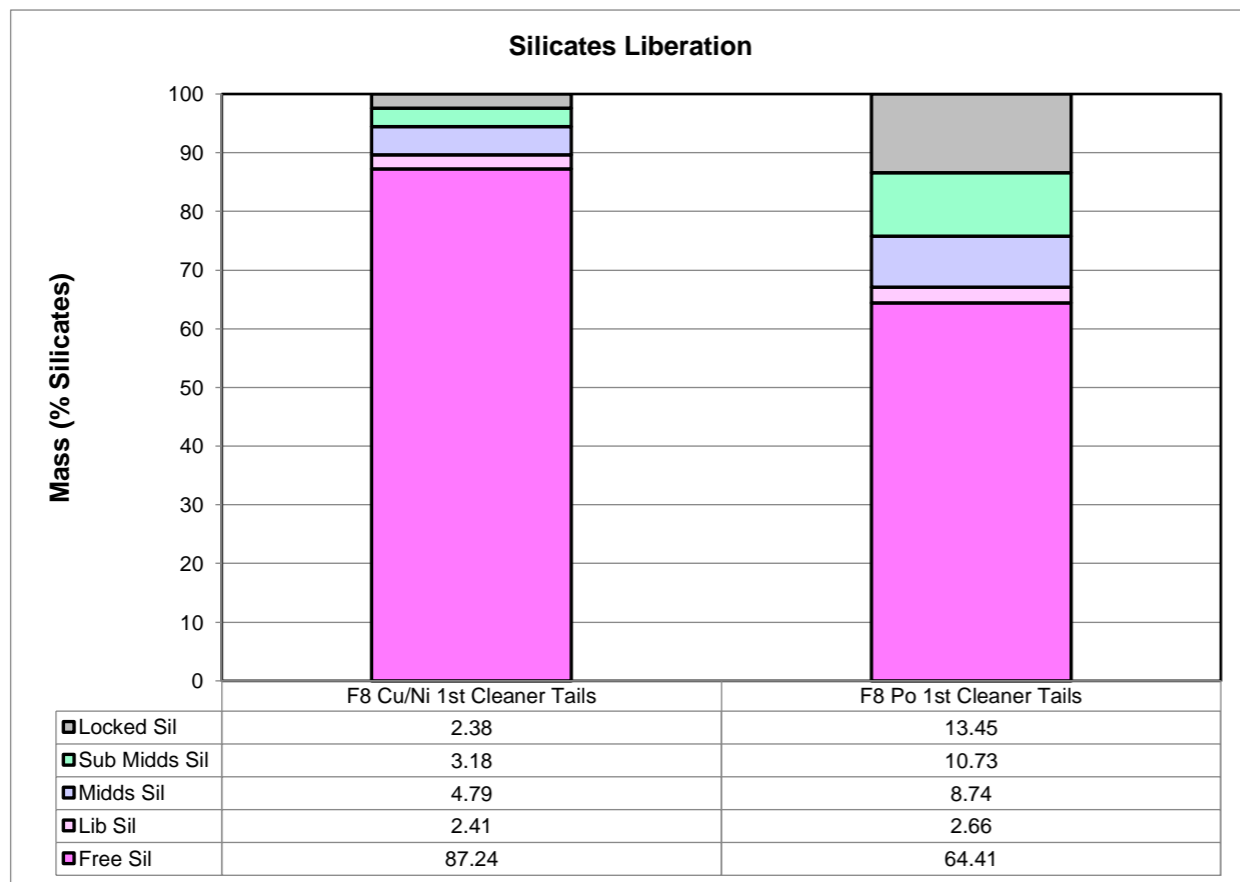

Normalized Mass of Silicates Across Samples

Mineral Name	F8 Cu/Ni 1st Cleaner Tails	F8 Po 1st Cleaner Tails
Free Sil	87.24	64.41
Lib Sil	2.41	2.66
Midds Sil	4.79	8.74
Sub Midds Sil	3.18	10.73
Locked Sil	2.38	13.45
Total	100.00	100.00

North American Nickel
18559-01
MI5012-JUL21

High Definition Mineralogical Analysis using QEMSCAN (Quantitative Evaluation of Materials by Scanning Electron Microscopy)

Silicates Association

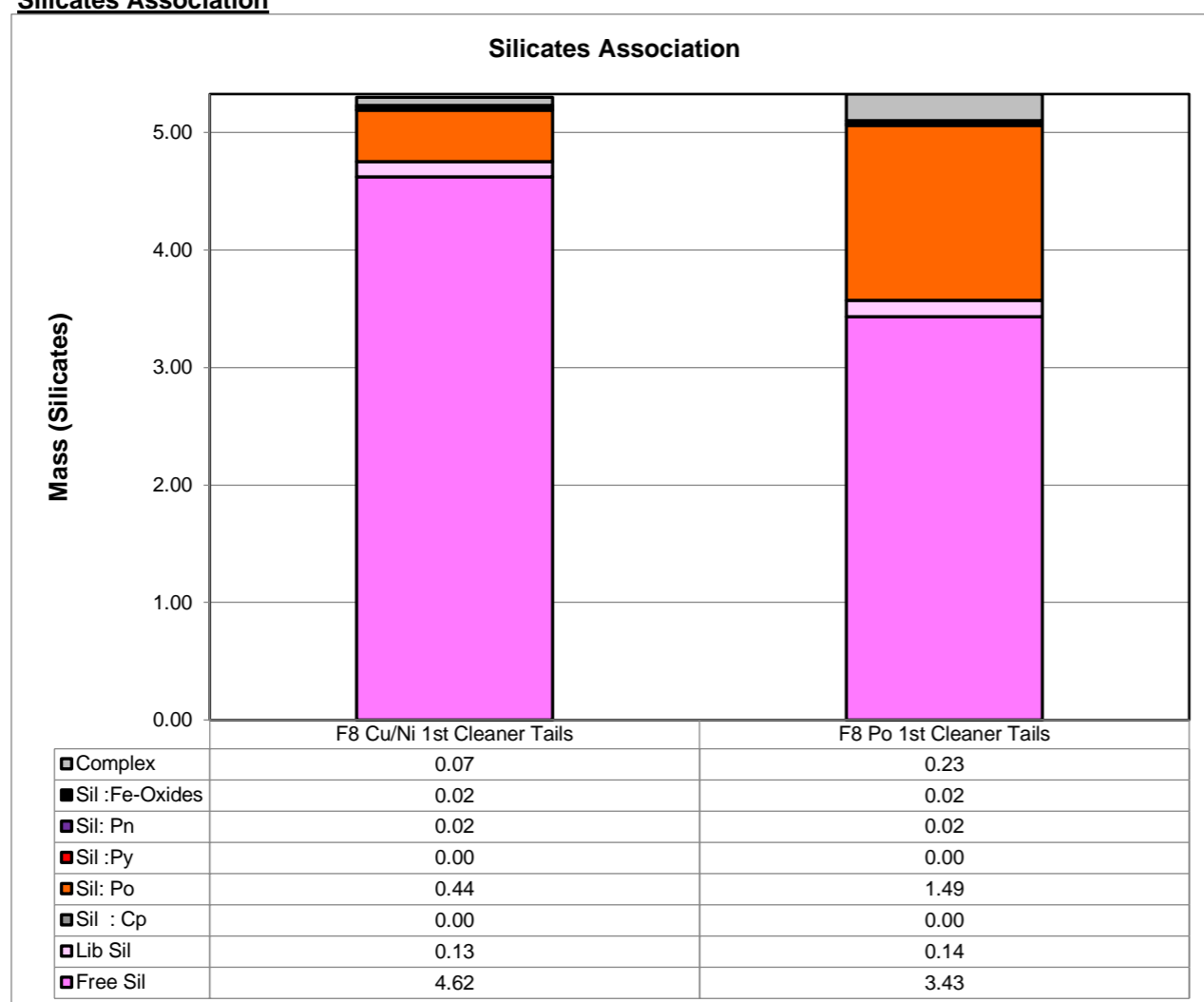

Absolute Mass of Silicates Across Samples

Mineral Name	F8 Cu/Ni 1st Cleaner Tails	F8 Po 1st Cleaner Tails
Free Sil	4.62	3.43
Lib Sil	0.13	0.14
Sil : Cp	0.00	0.00
Sil: Po	0.44	1.49
Sil :Py	0.00	0.00
Sil: Pn	0.02	0.02
Sil :Fe-Oxides	0.02	0.02
Complex	0.07	0.23
Total	5.30	5.33

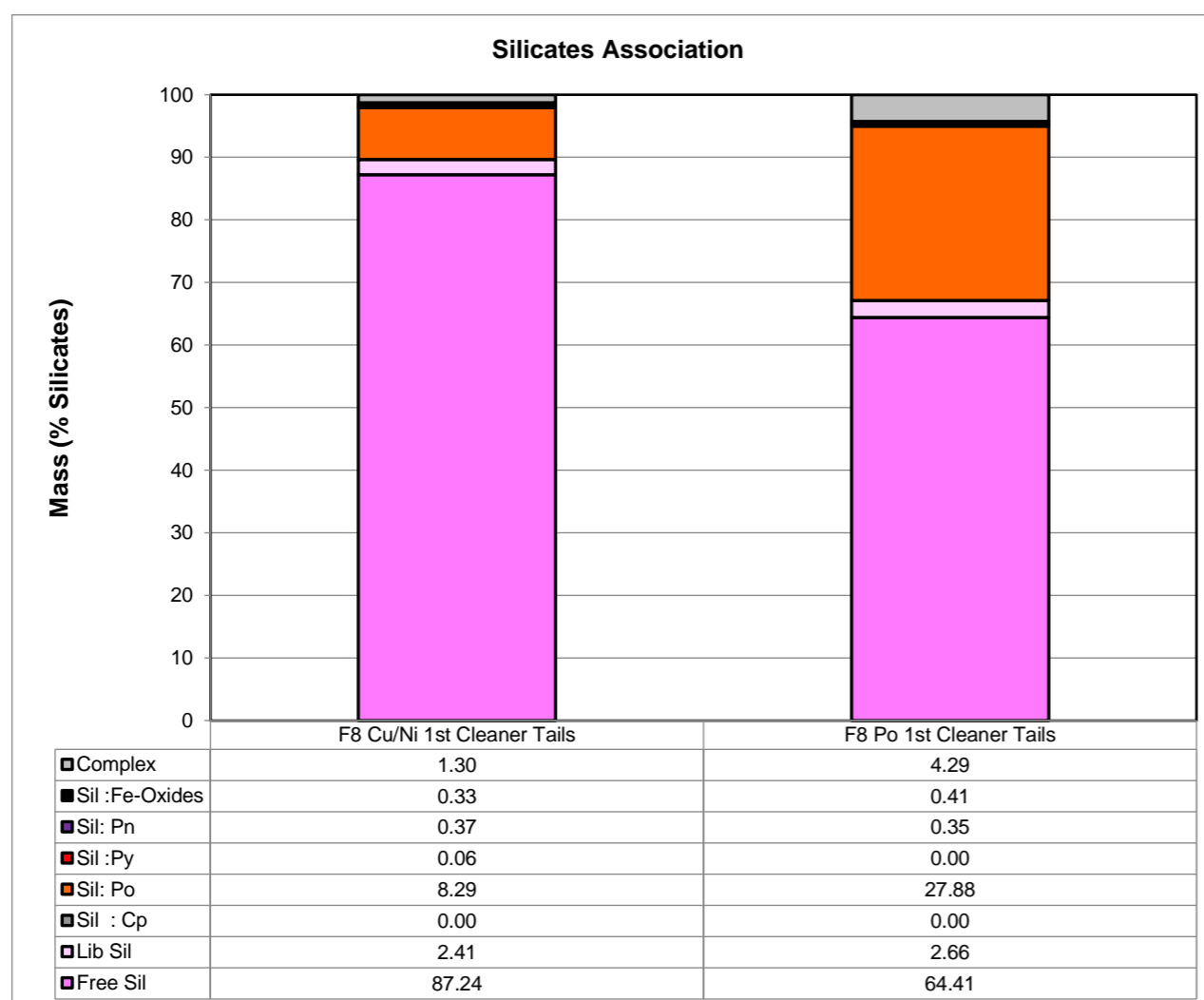

Normalized Mass of Silicates Across Samples

Mineral Name	F8 Cu/Ni 1st Cleaner Tails	F8 Po 1st Cleaner Tails
Free Sil	87.24	64.41
Lib Sil	2.41	2.66
Sil : Cp	0.00	0.00
Sil: Po	8.29	27.88
Sil :Py	0.06	0.00
Sil: Pn	0.37	0.35
Sil :Fe-Oxides	0.33	0.41
Complex	1.30	4.29
Total	100.00	100.00

North American Nickel
 18559-01
 MI5012-JUL21

High Definition Mineralogical Analysis using QEMSCAN (Quantitative Evaluation of Materials by Scanning Electron Microscopy)

Fe-Ox Liberation

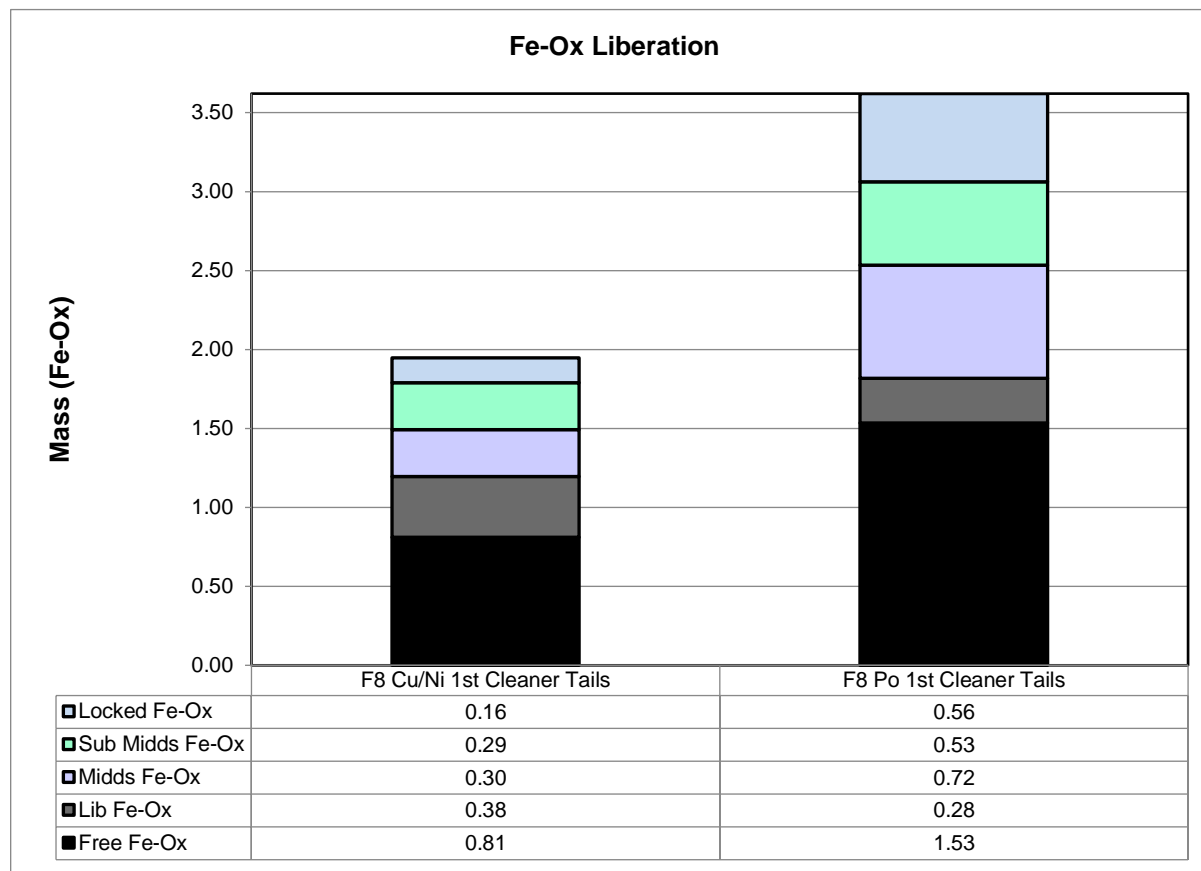

Absolute Mass of Fe-Ox Across Samples

Mineral Name	F8 Cu/Ni 1st Cleaner Tails	F8 Po 1st Cleaner Tails
Free Fe-Ox	0.81	1.53
Lib Fe-Ox	0.38	0.28
Midds Fe-Ox	0.30	0.72
Sub Midds Fe-Ox	0.29	0.53
Locked Fe-Ox	0.16	0.56
Total	1.95	3.62

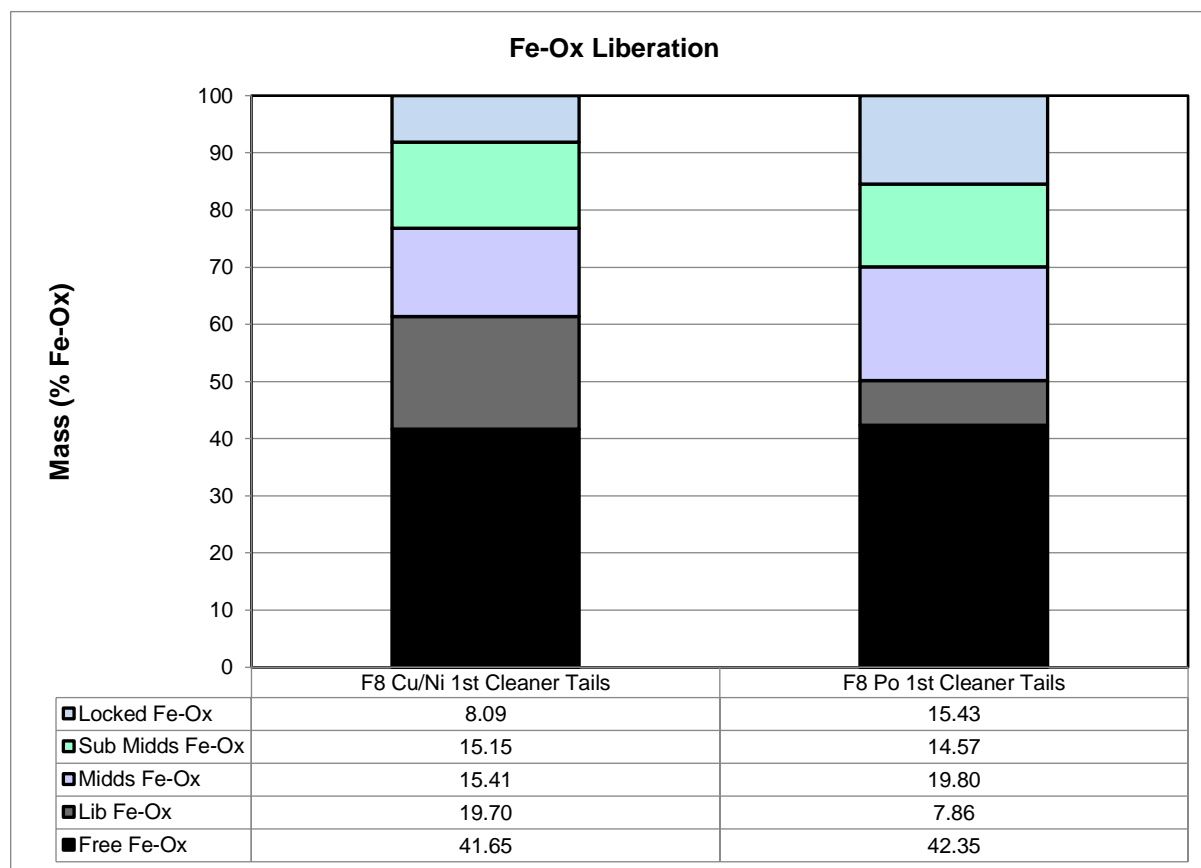

Normalized Mass of Fe-Ox Across Samples

Mineral Name	F8 Cu/Ni 1st Cleaner Tails	F8 Po 1st Cleaner Tails
Free Fe-Ox	41.65	42.35
Lib Fe-Ox	19.70	7.86
Midds Fe-Ox	15.41	19.80
Sub Midds Fe-Ox	15.15	14.57
Locked Fe-Ox	8.09	15.43
Total	100.00	100.00

North American Nickel
18559-01
MI5012-JUL21

High Definition Mineralogical Analysis using QEMSCAN (Quantitative Evaluation of Materials by Scanning Electron Microscopy)

Fe-Ox Association

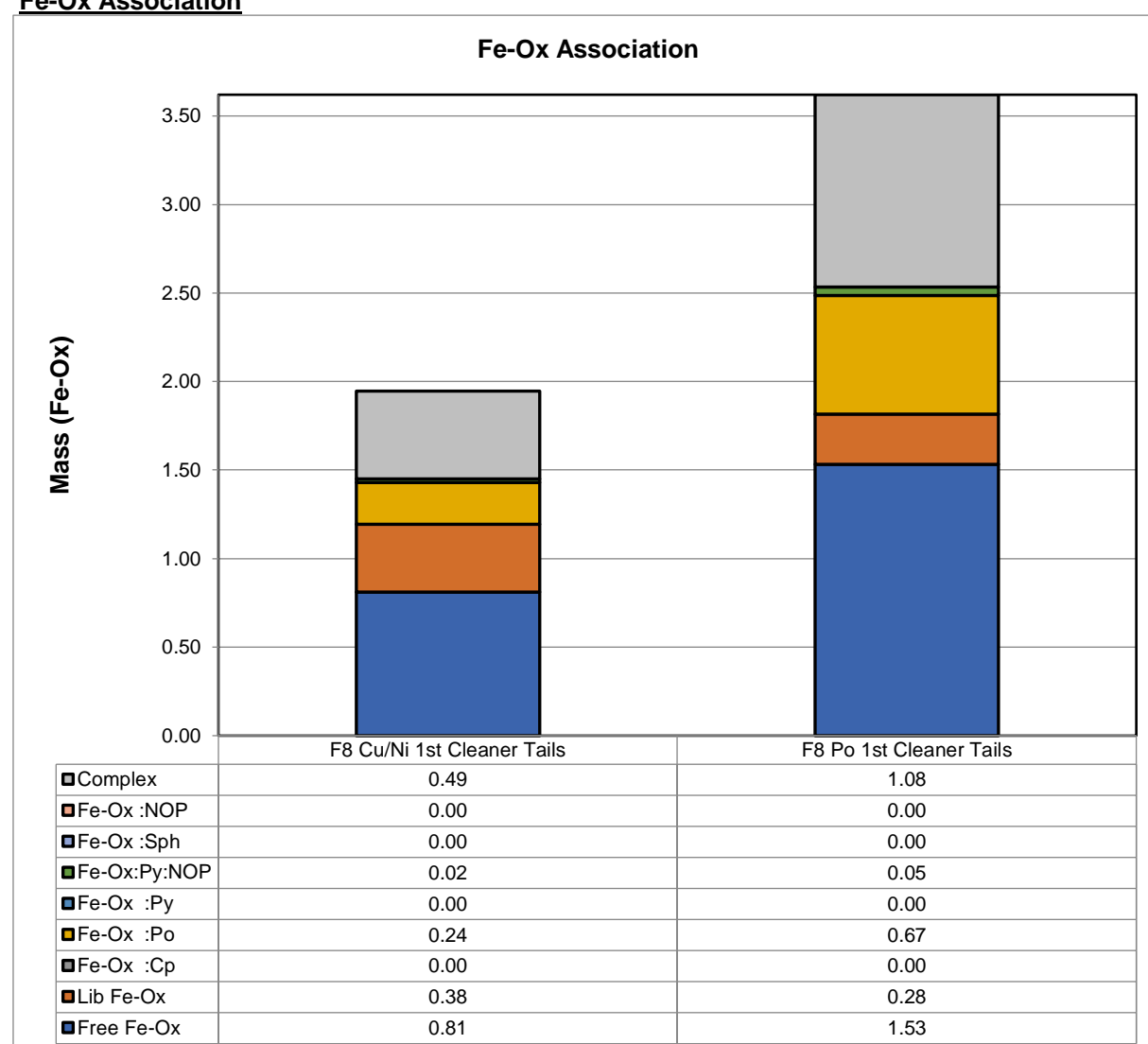

Absolute Mass of Fe-Ox Across Samples

Mineral Name	F8 Cu/Ni 1st Cleaner Tails	F8 Po 1st Cleaner Tails
Free Fe-Ox	0.81	1.53
Lib Fe-Ox	0.38	0.28
Fe-Ox :Cp	0.00	0.00
Fe-Ox :Po	0.24	0.67
Fe-Ox :Py	0.00	0.00
Fe-Ox:Py:NOP	0.02	0.05
Fe-Ox :Sph	0.00	0.00
Fe-Ox :NOP	0.00	0.00
Complex	0.49	1.08
Total	1.95	3.62

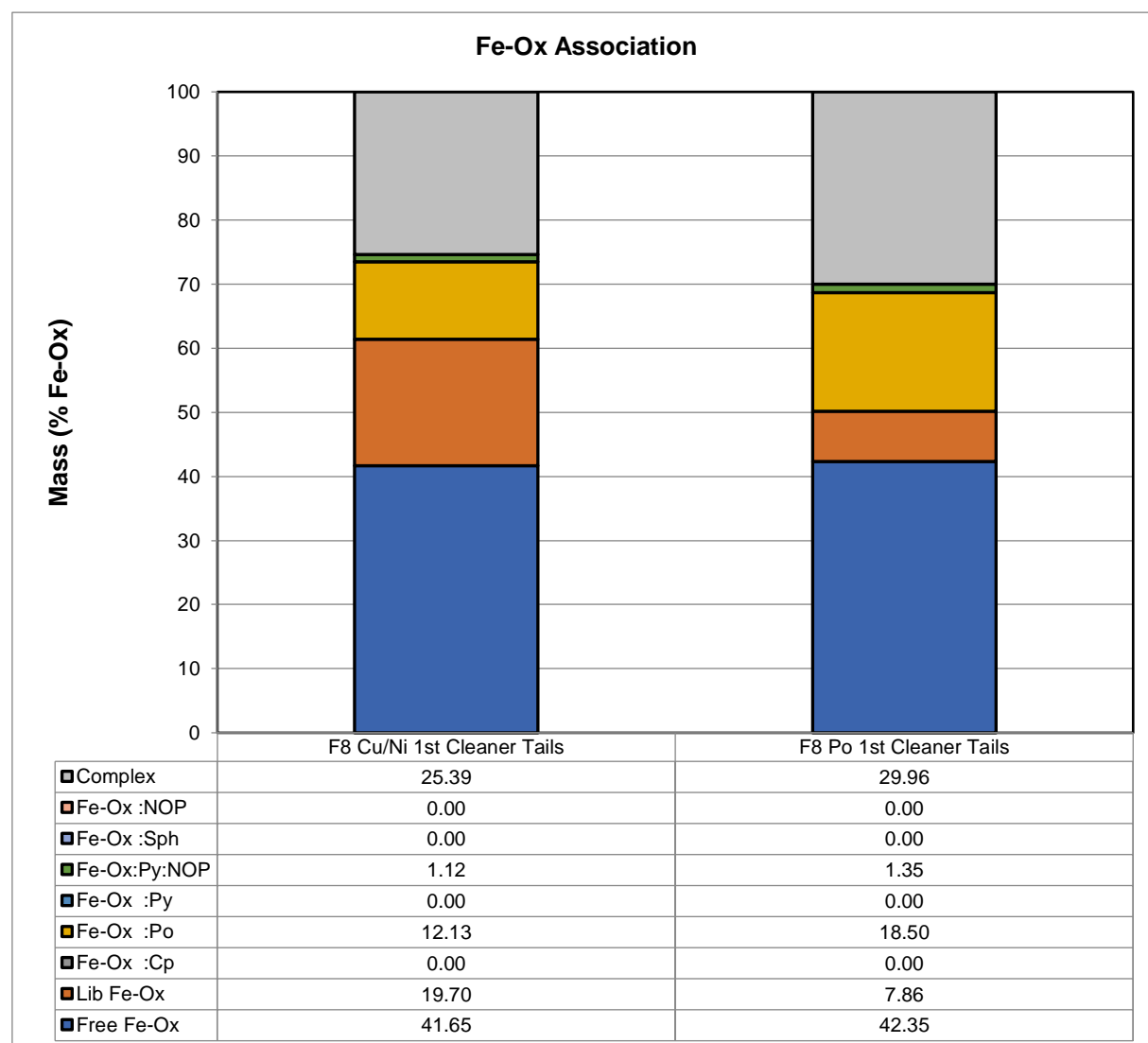

Normalized Mass of Fe-Ox Across Samples

Mineral Name	F8 Cu/Ni 1st Cleaner Tails	F8 Po 1st Cleaner Tails
Free Fe-Ox	41.65	42.35
Lib Fe-Ox	19.70	7.86
Fe-Ox :Cp	0.00	0.00
Fe-Ox :Po	12.13	18.50
Fe-Ox :Py	0.00	0.00
Fe-Ox:Py:NOP	1.12	1.35
Fe-Ox :Sph	0.00	0.00
Fe-Ox :NOP	0.00	0.00
Complex	25.39	29.96
Total	100.00	100.00

North American Nickel
 18559-01
 MI5012-JUL21

High Definition Mineralogical Analysis using QEMSCAN (Quantitative Evaluation of Materials by Scanning Electron Microscopy)

Cumulative Retained Grain Size Distribution

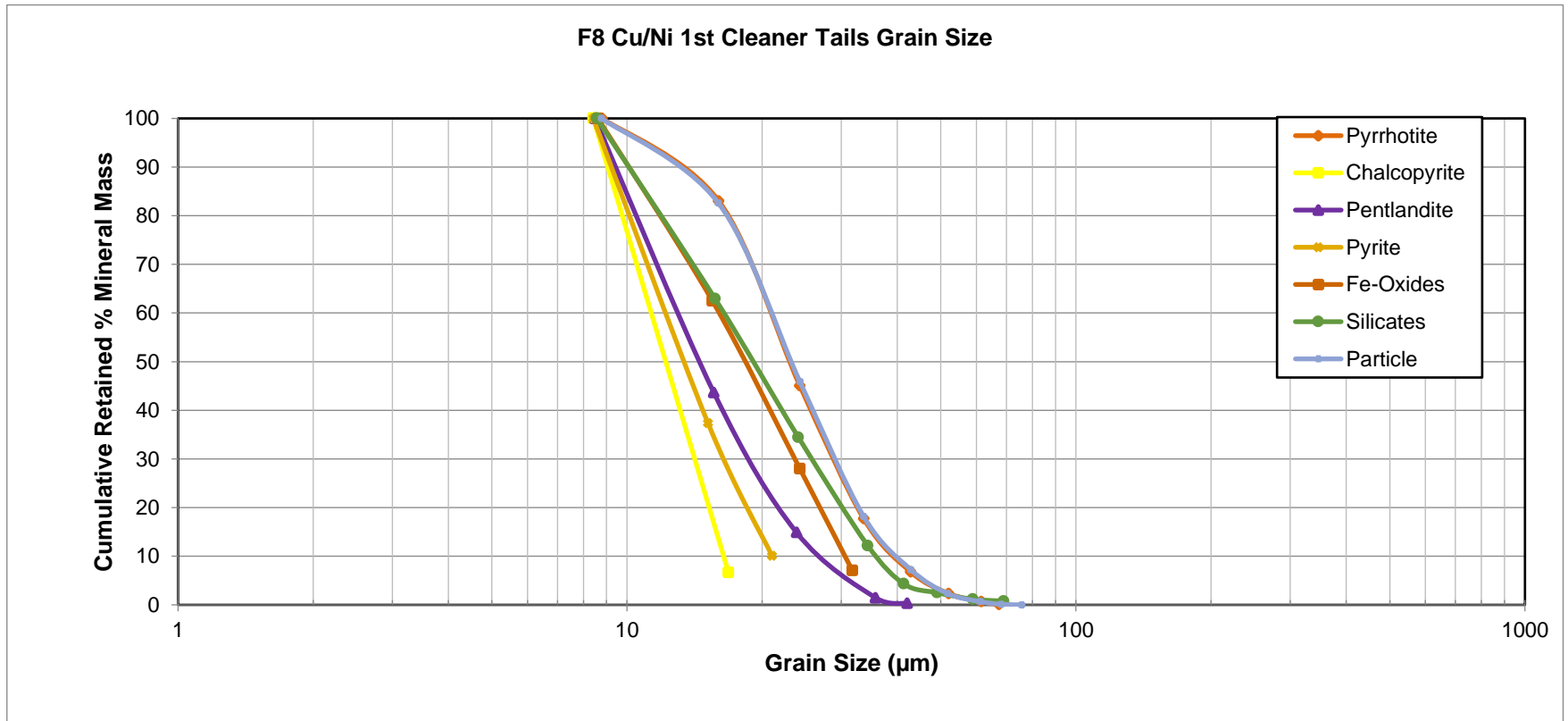

North American Nickel
 18559-01
 MI5012-JUL21

High Definition Mineralogical Analysis using QEMSCAN (Quantitative Evaluation of Materials by Scanning Electron Microscopy)

Cumulative Retained Grain Size Distribution

